

Description

Escalier hélicoïdal modulaire en métal à plan circulaire réglable en hauteur avec entretoises en métal entre les marches

N. marches et hauteurs possibles au "niveau du sol "

11 + 1 marches: 2520 - 2760 mm - 12 + 1 marches: 2730 - 2990 mm - 13 + 1 marches: 2940 - 3220 mm

Marches

En tôle étampée, avec bandes adhésive antidérapantes

Hauteur de marche

Standard Min. 210 mm ; Max 230 mm (pour hauteurs 200 ÷ 210 mm; 230 ÷ 240 mm balustres adaptables pendant la pose).

Rampe

Avec balustres en tube de métal Ø 22 mm (distance entre les balustres < 100 mm).
Main courante en matériel plastique flexible (hauteur main courante = 1 m).

Finitions et couleurs

Parties en métal: traitées en epoxy (Marches – Gris clair Ral 7035; balustres – noir gaufré).
Parties en plastique, tapis et visserie: noir.

Kit

- a) Carton n. 11 marches simples complètes Ø 1200, 1400, 1600 mm
- b) Carton palier d'arrivée complet Ø 1250, 1450, 1650 mm
- c) Carton marche simple supplémentaire Ø 1200, 1400, 1600 mm
- d) Carton garde-corps 1 m
- e) Carton " bras / hauteur de marche " pour n. 11 marches

Vérifier les dimensions de la cage avant de procéder à la pose. Vérifier que les fixations de l'escalier ne tombent pas sur des conduites ou des câbles électriques

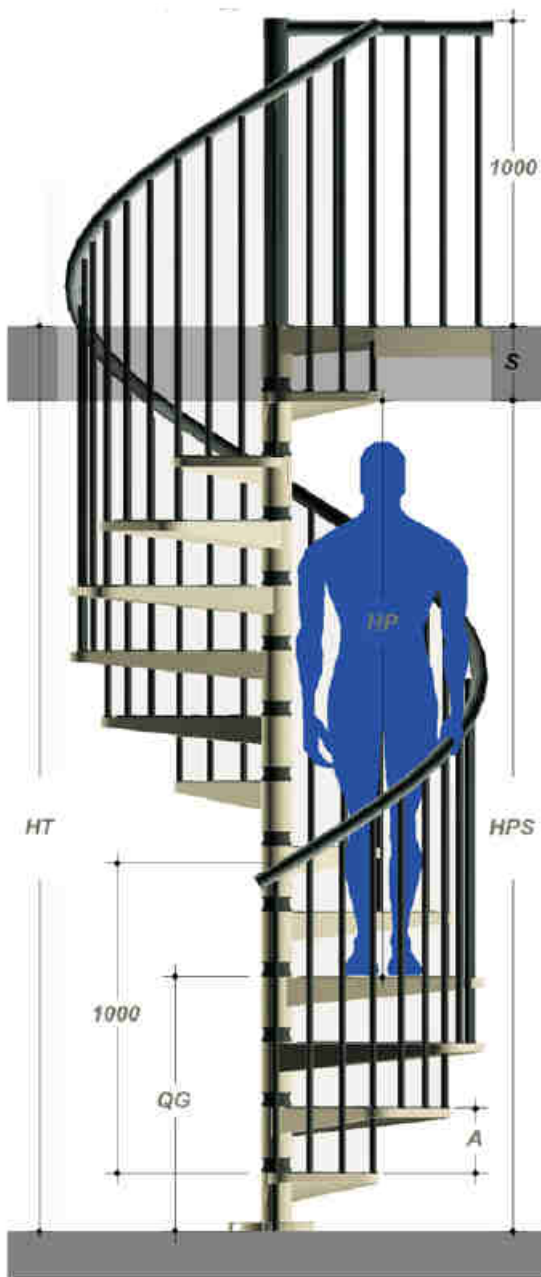

HT - Hauteur totale sol fini à sol fini (HPS+S)

HPS - Hauteur sous plafond (HT-S)

S - Epaisseur de la dalle (HT-HPS)

A - Hauteur de la marche (Hauteur totale : n.hauteurs de marches)

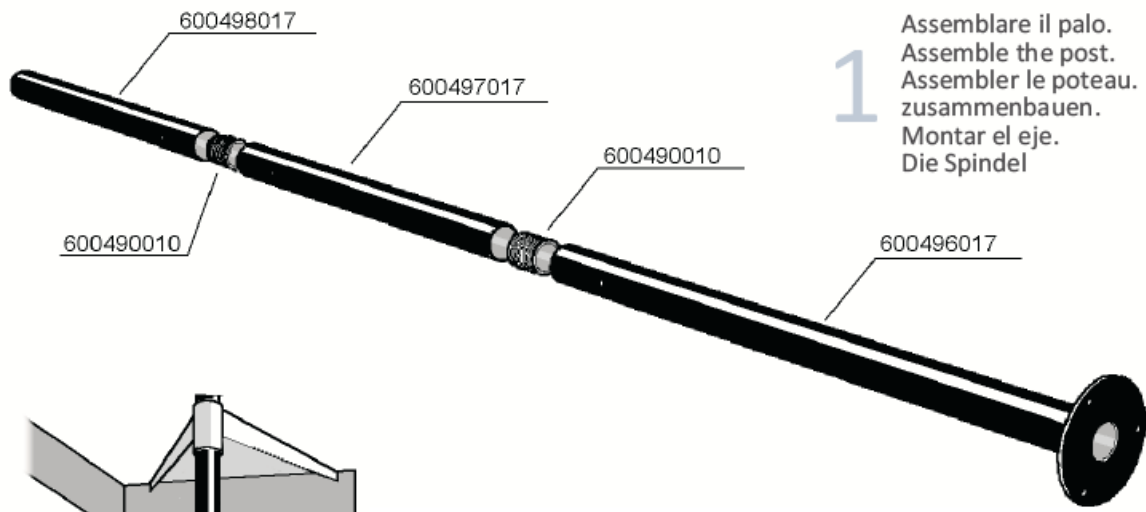

1

Assemblare il palo.
Assemble the post.
Assembler le poteau.
zusammenbauen.
Montar el eje.
Die Spindel

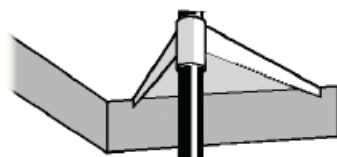

2

Positionner le poteau dans l'axe exact de la trémie, en plaçant la marche d'arrivée sur le côté de sortie de l'escalier.



630333042

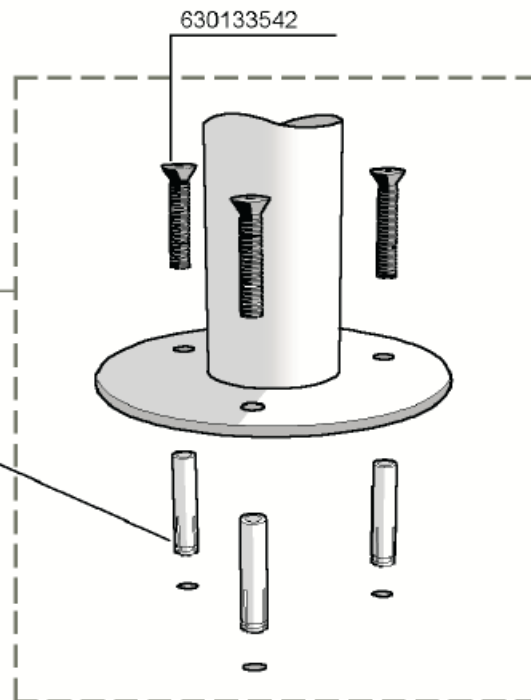

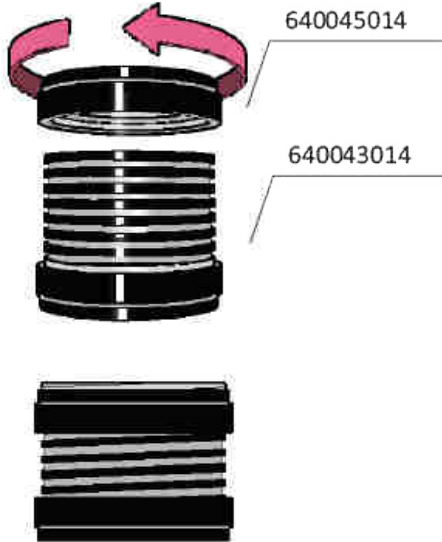

3

Régler les entretoises en plastique en serrant la bague fileté et en gardant une distance égale à "Hauteur de marche - 170 mm".

Alzata 170 mm
Riser-170 mm (6 11/16")
Hauteur de marche - 170 mm
Contrahuella 170 mm
Steigung - 170 mm

4

Empiler tour à tour les éléments (entretoises et marches) dans le poteau sans oublier au départ le couvreembase et terminer avec l'installation de la marche d'arrivée.

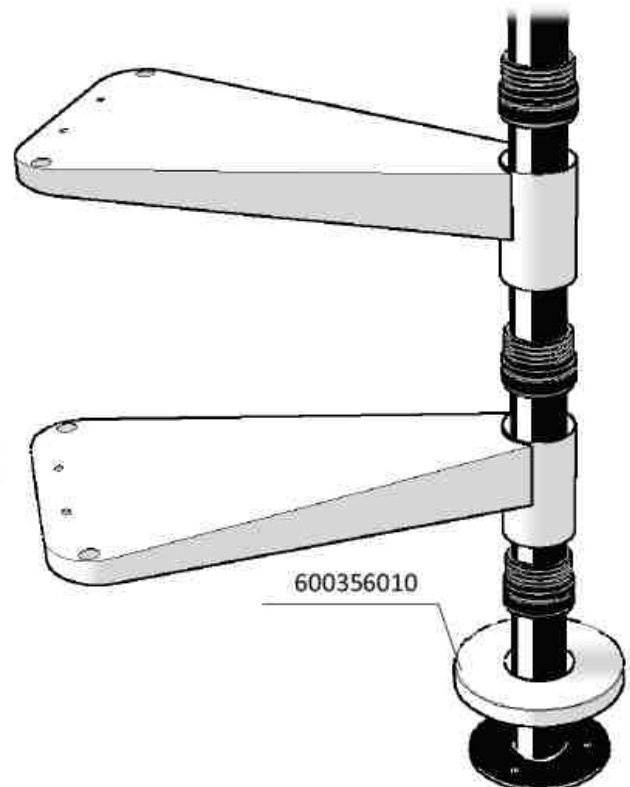

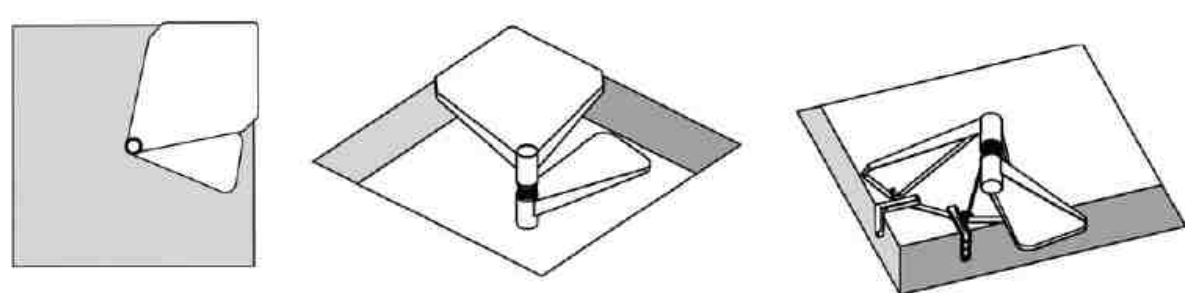
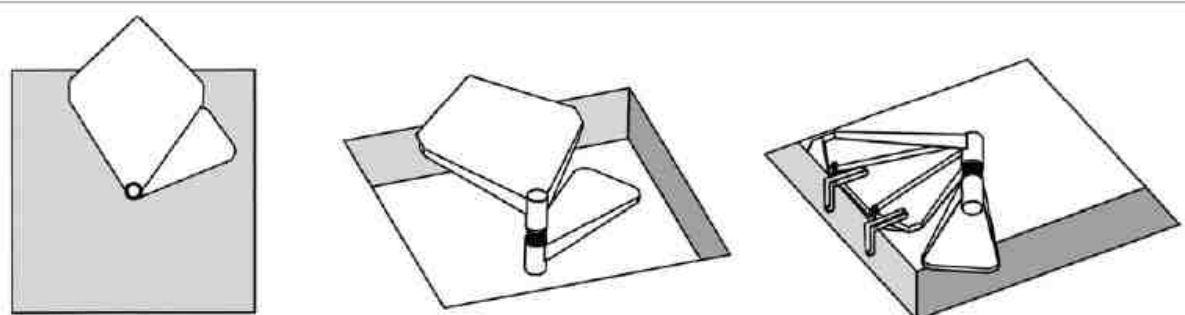
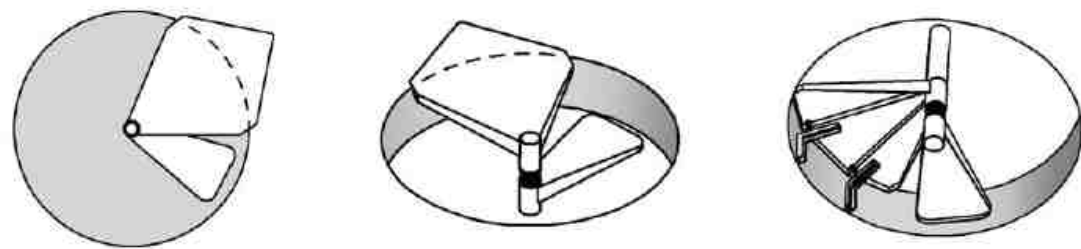

5

Positionner la marche d'arrivée.

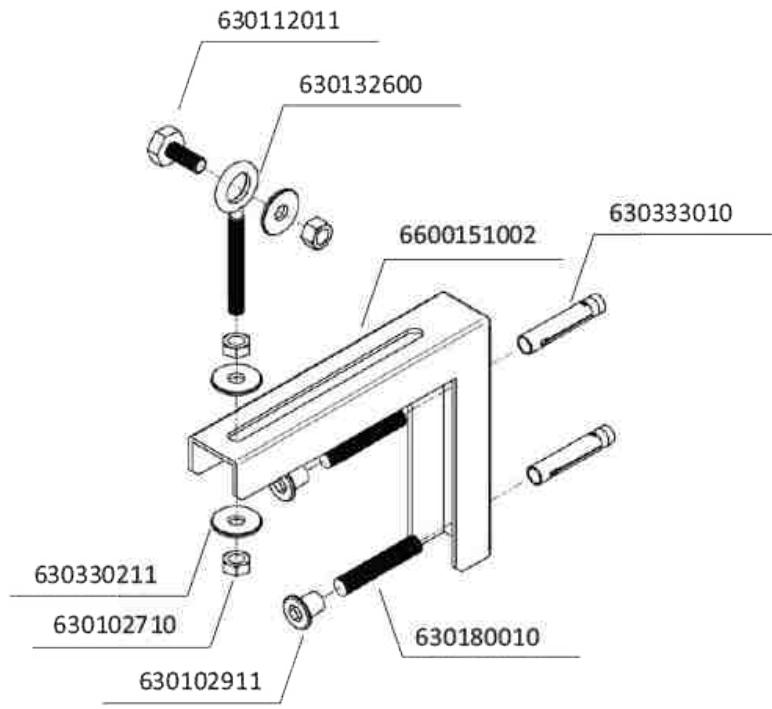

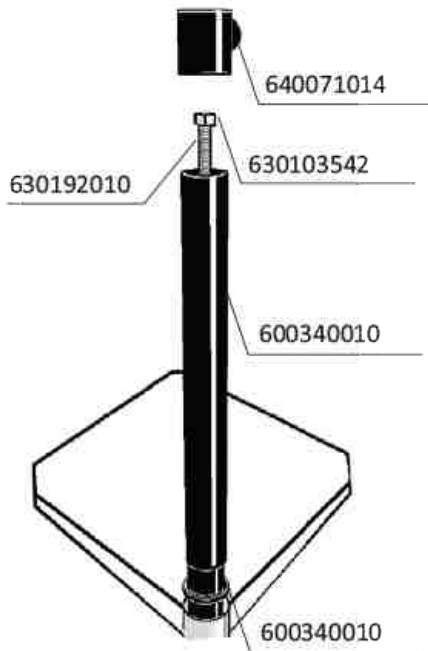

6 Insérer dans le poteau le bride terminal.

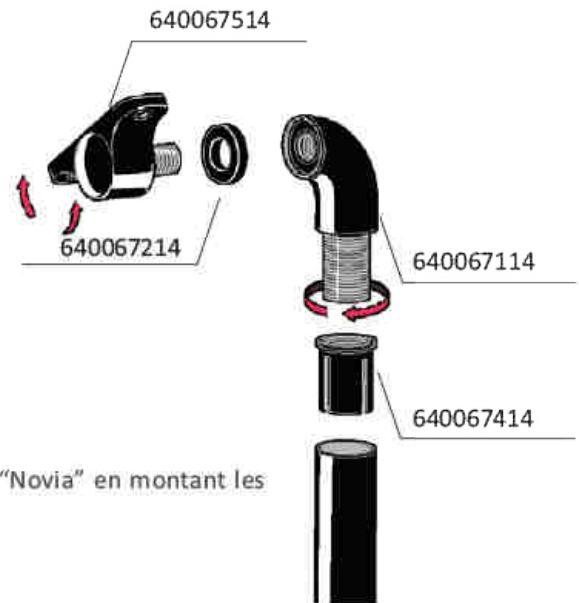

7 Assembler le raccord "Novia" en montant les éléments.

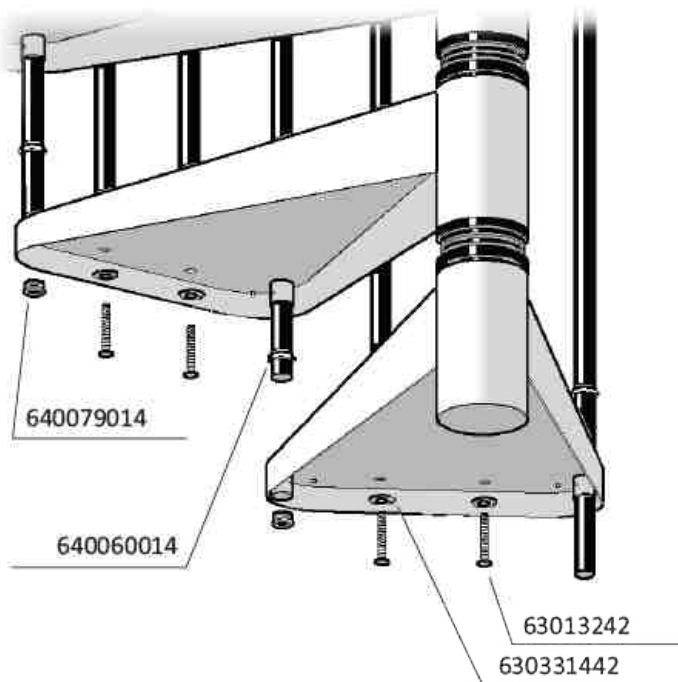

8 Insérer les balustres dans toutes les marches en bloquant ceux du type passant avec les vis et ceux sur la marche avec l'expansion "Espa".

9 Découper et fixer au sol le premier balustre avec le gobelet "Bicchierino".

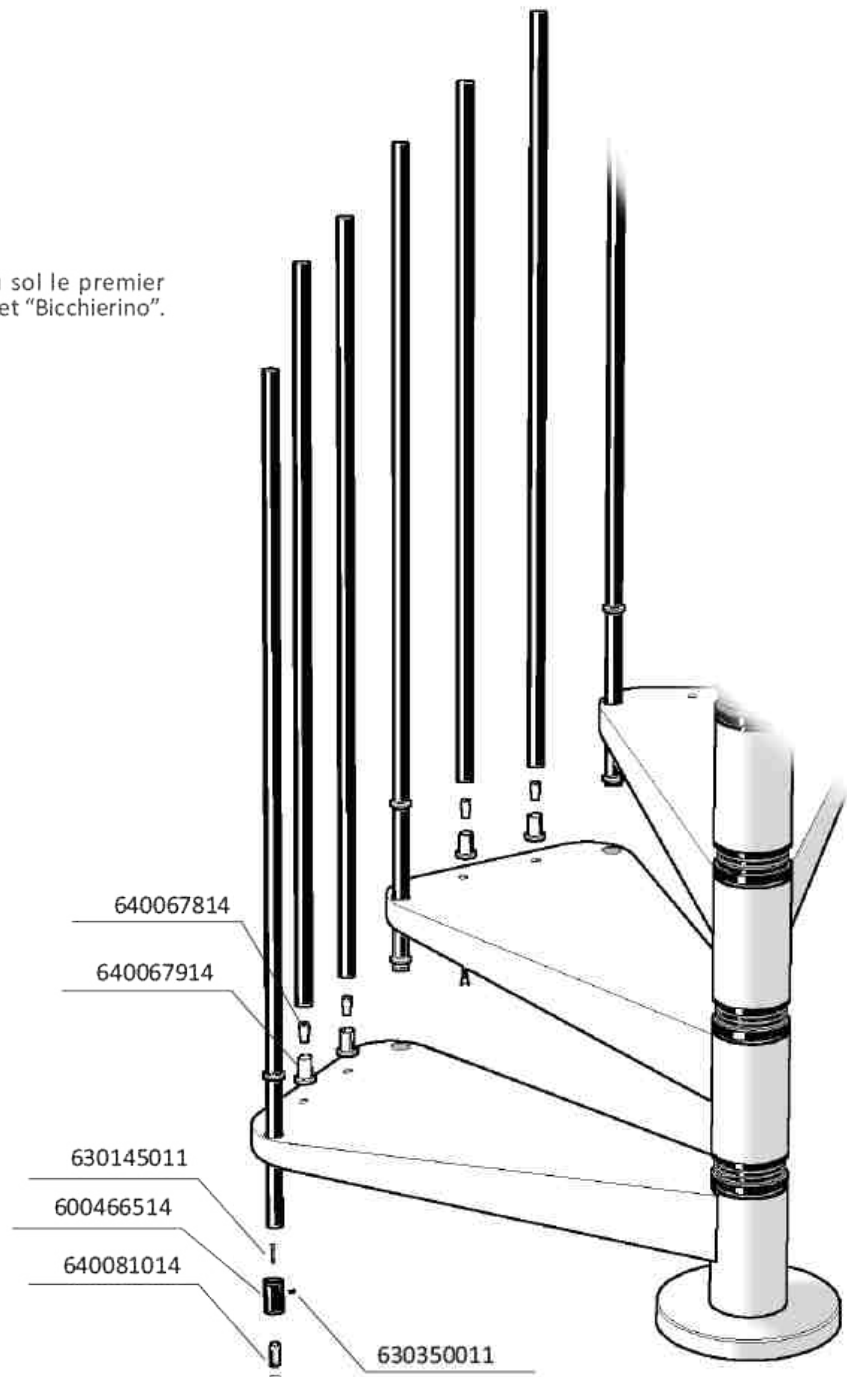

10

Réglage des balustres

Avant de bloquer les balustres,
régler les en fonction de la pente
créée par la hauteur de marche.

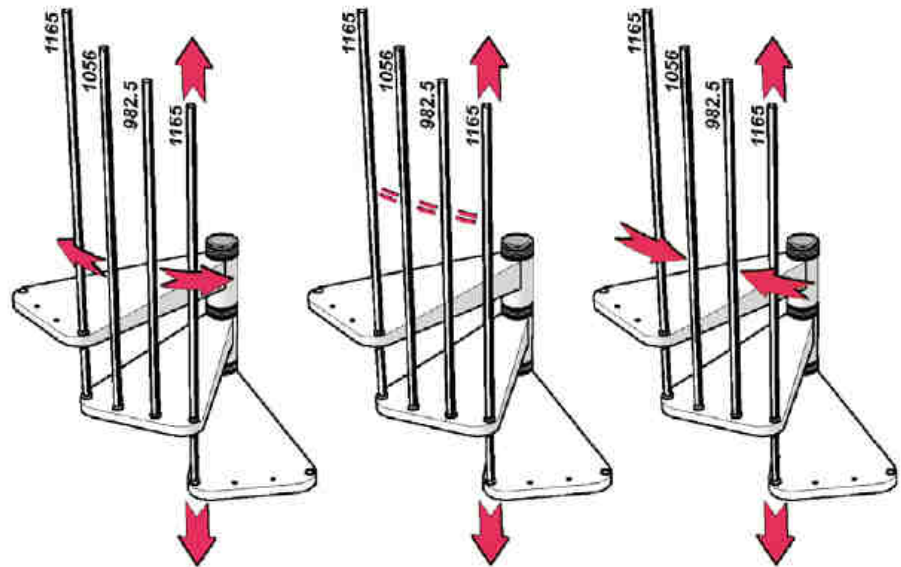

Ø scala / stair / escalier / escalera / treppe
120 - 140 mm; (47 1/4" - 55 1/8");

Ø scala / stair / escalier / escalera / treppe
160 mm (63")

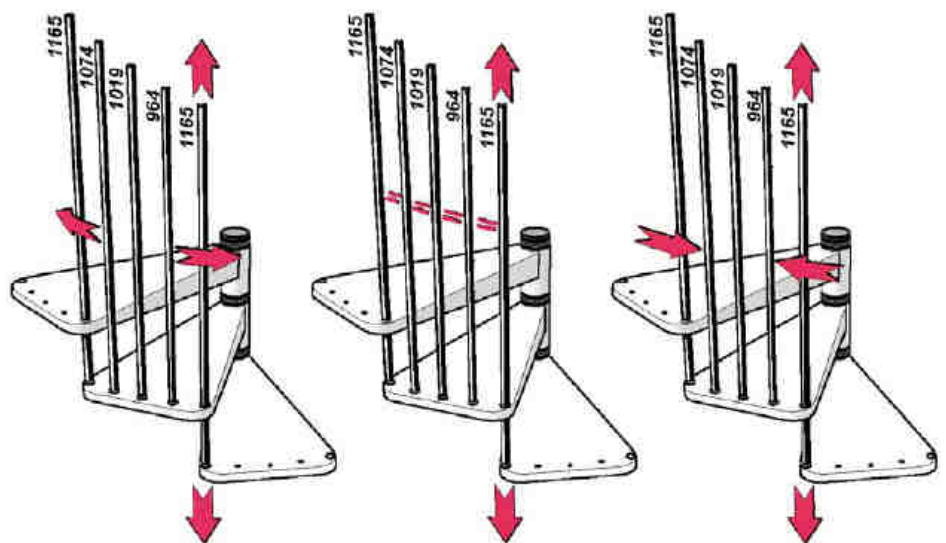



11

Ce dessin montre le kit bras / hauteur de marche assemblé sur le modèle GAMIA BOIS. Pour l'escalier GAMIA METAL les instructions de montage sont les mêmes.

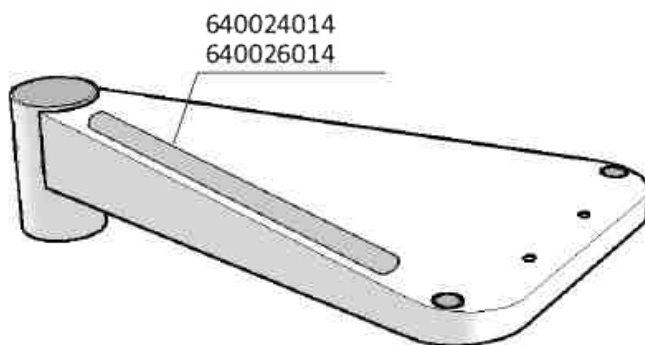

12

Une fois le montage de l'escalier terminé, appliquer sur toutes les marches bandes adhésives antidérapantes

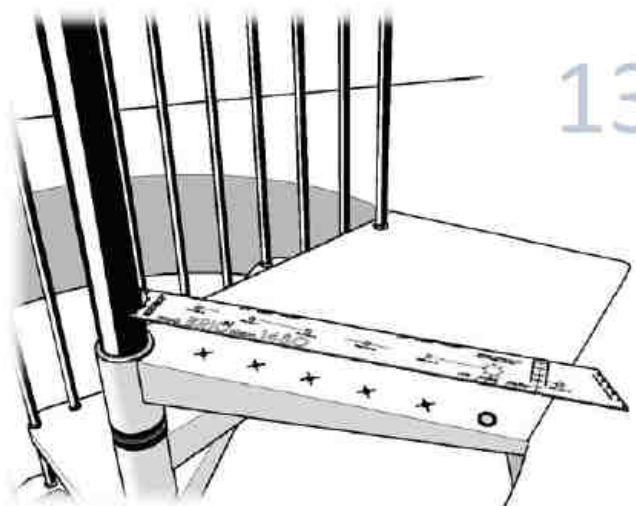

13

Montage de la rampe du palier d'arrivée
Percer la marche d'arrivée avec un foret Ø 10 mm en utilisant le gabarit en carton fourni.

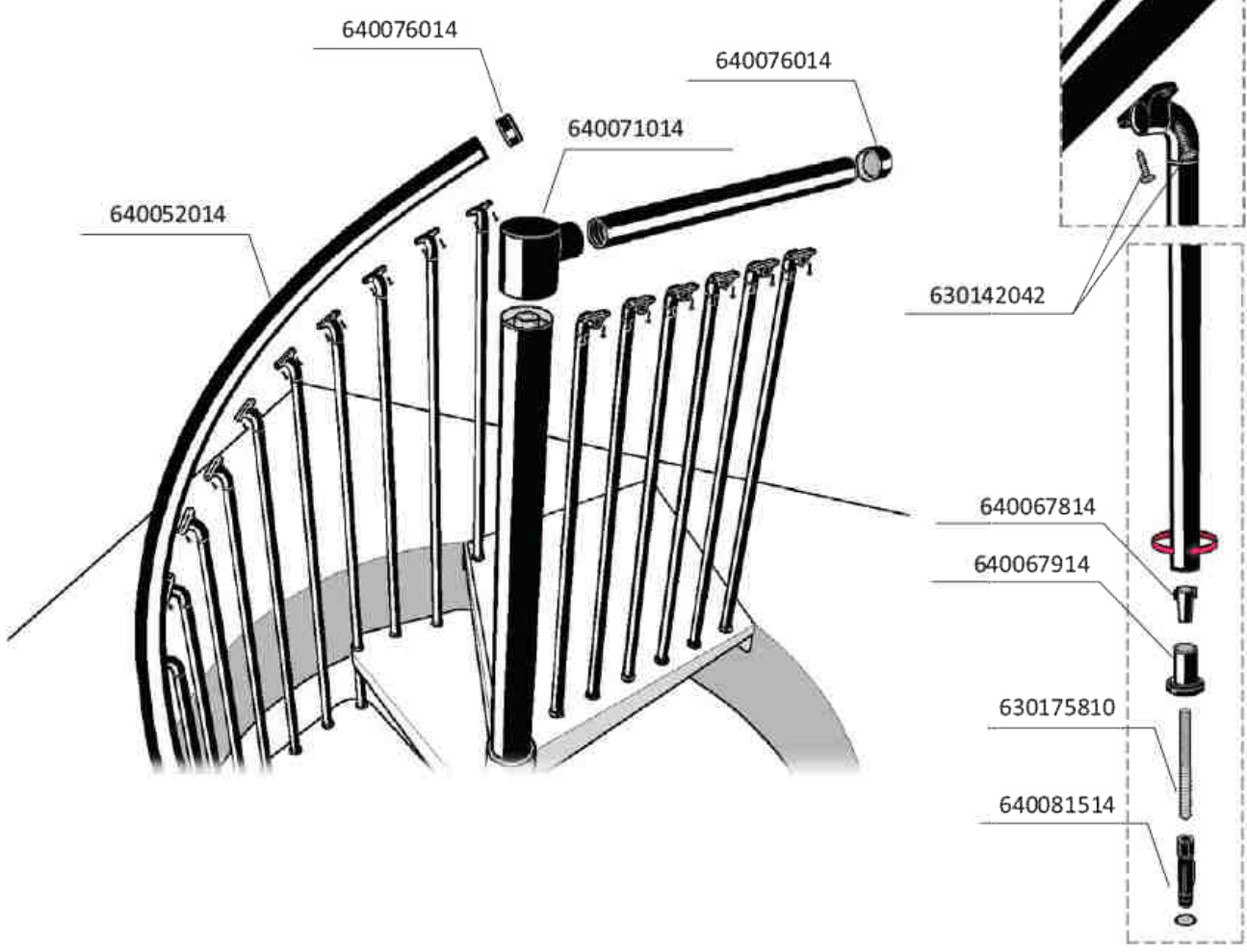

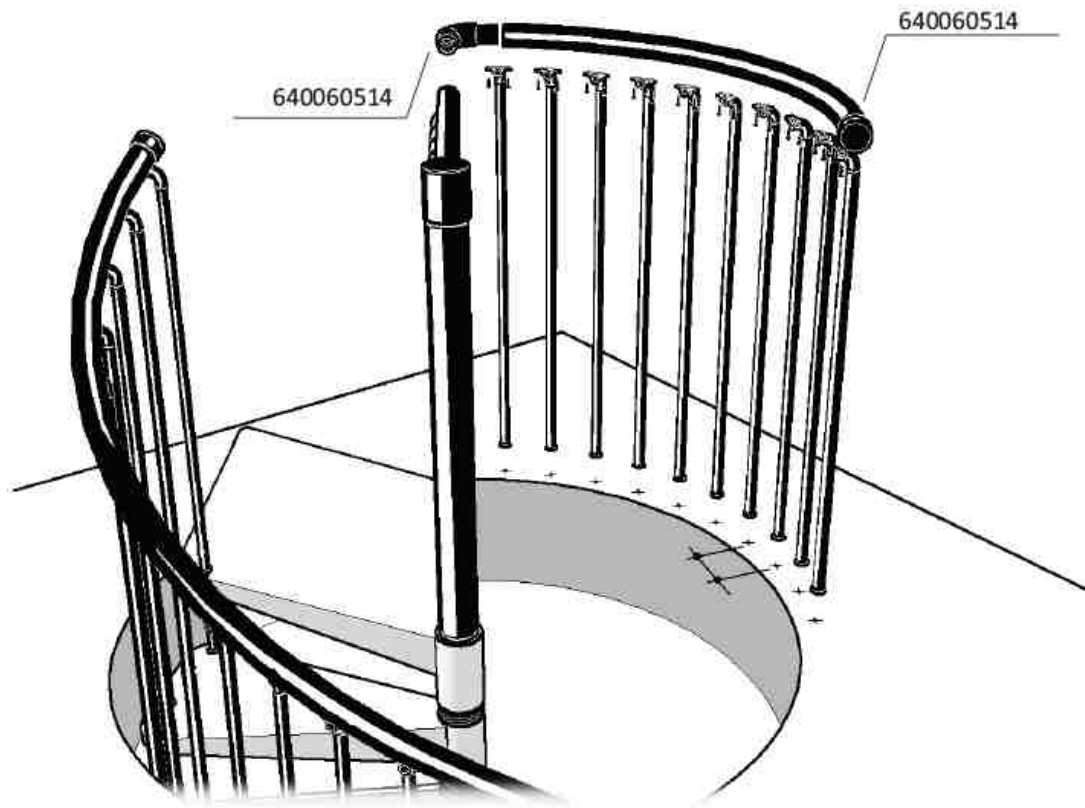

































14















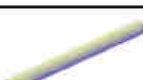

Montage du garde-corps

















-Assembler les balustres du garde-corps (h. 925 mm) en insérant la pièce "Espa" et en serrant le mordant.
-Tracer au sol l'axe des balustres du garde corps en gardant une distance par rapport au bord de la trémie d'environ 50 mm (L'entraxe entre les balustres ne doit pas excéder les 120 mm). - Percer avec un foret \varnothing 12 mm et insérer les chevilles à expansion en nylon.

Ø 1200	KIT 12+1	COD.	IMAGE
	12	600042002	
	1	600100202	
	13	640024014	
	5	600230514	
	12	600231714	
	12	600232514	
	14	600233014	
	2	600151002	
	1	600343002	
	1	600356002	
	2	600490000	
	1	600496002	
	1	600497002	
	1	600498002	
	1	600340002	
	1	600467514	

















Ø 1200	KIT 12+1	COD.	IMAGE
	2	600466514	
	1	630103510	
	6	630102710	
	88	630142011	
	2	630145011	
	4	630180010	
	2	630132600	
	3	630133511	
	30	630132011	
	2	630112011	
	1	630192000	
	42	630350011	
	7	630333010	
	4	630102911	
	30	630331411	
	6	630330211	

















Ø 1200	KIT 12+1	COD.	IMAGE
	1	9964520	
	44	640067114	
	44	640067214	
	44	640067414	
	44	640067514	
	1	640071014	
	3	640076014	
	12	640079014	
	1	650800000	
	13	640043014	
	13	640045014	
	30	640067814	
	30	640067914	
	2	640081014	
	27	640060014	

Ø 1400	KIT 12+1	COD.	IMAGE
	12	600044002	
	1	600100402	
	13	640026014	
	5	600230514	
	12	600231714	
	12	600232514	
	14	600233014	
	2	600151002	
	1	600343002	
	1	600356002	
	2	600490000	
	1	600496002	
	1	600497002	
	1	600498002	
	1	600340002	
	1	600467514	

Ø 1400	KIT 12+1	COD.	IMAGE
	2	600466514	
	1	630103510	
	6	630102710	
	88	630142011	
	2	630145011	
	4	630180010	
	2	630132600	
	3	630133511	
	30	630132011	
	2	630112011	
	1	630192000	
	42	630350011	
	7	630333010	
	4	630102911	
	30	630331411	
	6	630330211	

Ø 1400	KIT 12+1	COD.	IMAGE
	-	9964520	
	1	9964525	
	44	640067114	
	44	640067214	
	44	640067414	
	44	640067514	
	1	640071014	
	3	640076014	
	11	640079014	
	1	650800000	
	13	640043014	
	13	640045014	
	30	640067814	
	30	640067914	
	2	640081014	
	27	640060014	

Ø 1600	Q. KIT 12+1	COD.	IMAGE
	12	600044002	
	1	600100402	
	13	640026014	
	6	600230514	
	12	600231714	
	12	600232514	
	12	600232714	
	14	600233014	
	2	600151002	
	1	600343002	
	1	600356002	
	2	600490000	
	1	600496002	
	1	600497002	
	1	600498002	
	1	600340002	

Ø 1600	Q. KIT 12+1	COD.	IMAGE
	2	600467514	
	3	600466514	
	1	630103510	
	6	630102710	
	114	630142011	
	3	630145011	
	4	630180010	
	2	630132600	
	3	630133511	
	43	630132011	
	2	630112011	
	1	630192000	
	43	630350011	
	7	630333010	
	4	630102911	
	43	630331411	

Ø 1600	Q. KIT 12+1	COD.	IMAGE
	6	630330211	
	1	9964525	
	57	640067114	
	57	640067214	
	57	640067414	
	57	640067514	
	1	640071014	
	3	640076014	
	12	640079014	
	1	650800000	
	13	640043014	
	13	640045014	
	43	640067814	
	43	640067914	
	3	640081014	
	26	640060014	