

BG	ПРАВА ТАВАНСКА СЪЛБА	HU	MOLNÁR LÉPCSŐ
CH	RAUMSPARTREPP	IT	SCALA FISSASCALE FISSA
CS	MLYNÁRSKÉ PŮDNÍ SCHODY	NL	MOLENAARSTRAP
DE	RAUMSPARTREPP	PL	SCHODY MŁYNARSKIE
ES	ESCALERA MODULAR	RO	SCĂRI FIXE
FR	ÉCHELLE MEUNIÈRE	RU	ЛЕСНИЦА "ДАЧНИЦА"
GB	THE STAIR CASE	SK	MĽYNÁRSKE SCHODY
GR	ΣΤΑΘΕΡΗ ΣΚΑΛΑ	UA	СХОДИ СТАЦІОНАРНІ
HR	MLINAR LJESTVE		

## MSA

H<sub>max</sub> = 300cm

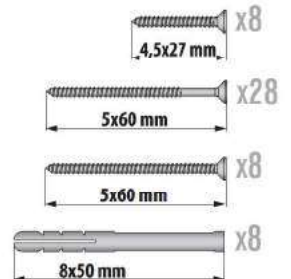
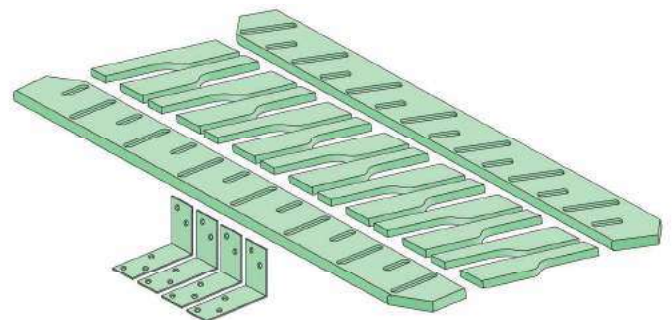

**WARNING! - ACHTUNG! - UWAGA! - ATTENTION! - CUIDADO! - BИMАНИЕ!**

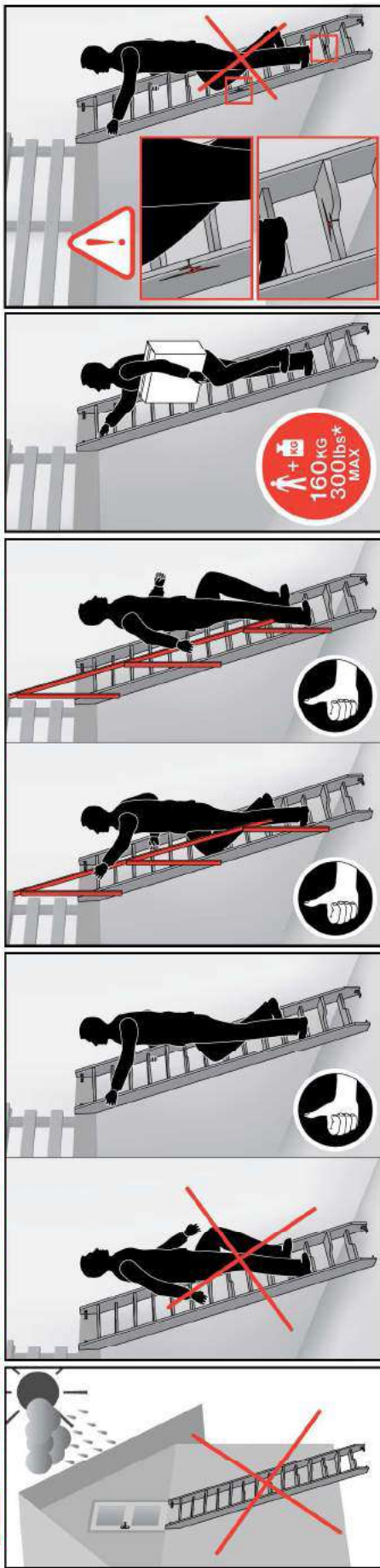

**CZ** Výrobce a Prodávce nenesú žádnou odpovědnost za nedodržení příslušných předpisů zákona, stavebních předpisů a bezpečnostních požadavků při užívání výrobku, architekta, montéra nebo majitele objektu.

**DE** Hersteller und Verkäufer übernehmen keine Haftung für Nichtbeachtung entsprechender Rechts- und Bauvorschriften sowie Sicherheitsanforderungen seitens Produktbenutzer, Architekten, Monteurs oder Gebäudebesitzer.

**ES** El fabricante y el vendedor no tienen ninguna responsabilidad por el incumplimiento de la ley vigente, normas de construcción y exigencias de seguridad por parte del usuario del producto, arquitecto, instalador o el propietario del edificio.

**FR** Le fabricant et le vendeur ne prend aucune responsabilité de ne pas respecter les lois applicables, les règlements sur les bâtiments et les exigences de sécurité par l'utilisateur du produit, l'architecte, l'installateur ou le propriétaire du bâtiment.

**GB** Manufacturer and Seller shall bear no liability for failure to comply with the applicable laws, building codes and safety requirements by the user of the product, architect, fitter or owner of the building.

**HU** A gyártó és a forgalmazó nem vállal semmilyen felelősséget a vonatkozó törvényi, építési és biztonsági előírások, szerelési előírások, építési, balesetvédelem vagy egyéb előírások által be nem tartásáért.

**IT** Il Produttore e il rivenditore non potranno essere ritenuti responsabili per il mancato rispetto da parte dell'utente del prodotto, del progettista, dell'installatore o del proprietario dell'edificio, delle leggi vigenti, nonché dei regolamenti edilizi e quelli relativi alla sicurezza.

**NL** De fabrikant en verkoper zijn niet aansprakelijk, voor gevolgen bij het niet opvolgen van toepasselijke wetten, bouwbesluiten en veiligheidsvoorschriften door de gebruiker van het product, de architect, de installateur of de eigenaar van het gebouw.

**PL** Producent i Sprzedawca nie ponoszą żadnej odpowiedzialności za nieprzeobrażenie stosownych przepisów prawa, przepisów budowlanych i wymogów bezpieczeństwa przez użytkowników produktu, architektów, monterów lub właścicieli budynków.

**PT** O fabricante e o vendedor não têm nenhuma responsabilidade pelo o não cumprimento da lei, códigos de construção e as exigências de segurança por parte do usuário do produto, arquiteto, instalador ou proprietário do edifício.

**RO** Fabricantul și vânzătorul nu își vor asuma niciun fel de răspundere pentru nerespectarea legilor în vigoare, a legilor din domeniul construcțiilor sau a măsurilor de siguranță impuse de către autoritatea producătorului, arhitectului, montajistului sau proprietarului clădirii.

**RU** Производитель и продавец несут ответственность за неисполнение пользователями строительных правил и норм безопасности, ответственности с проектировщика и продавца объектов.

**SK** Výrobca a predávca nenesú žiadnu zodpovednosť za nedodržanie príslušných ustanovení zákona, stavebných predpisov a bezpečnostných požiadaviek užívateľom výrobku, architektom, montérom alebo majiteľom objektu.

NC 9EH IM/MSA.01.12.2015/F



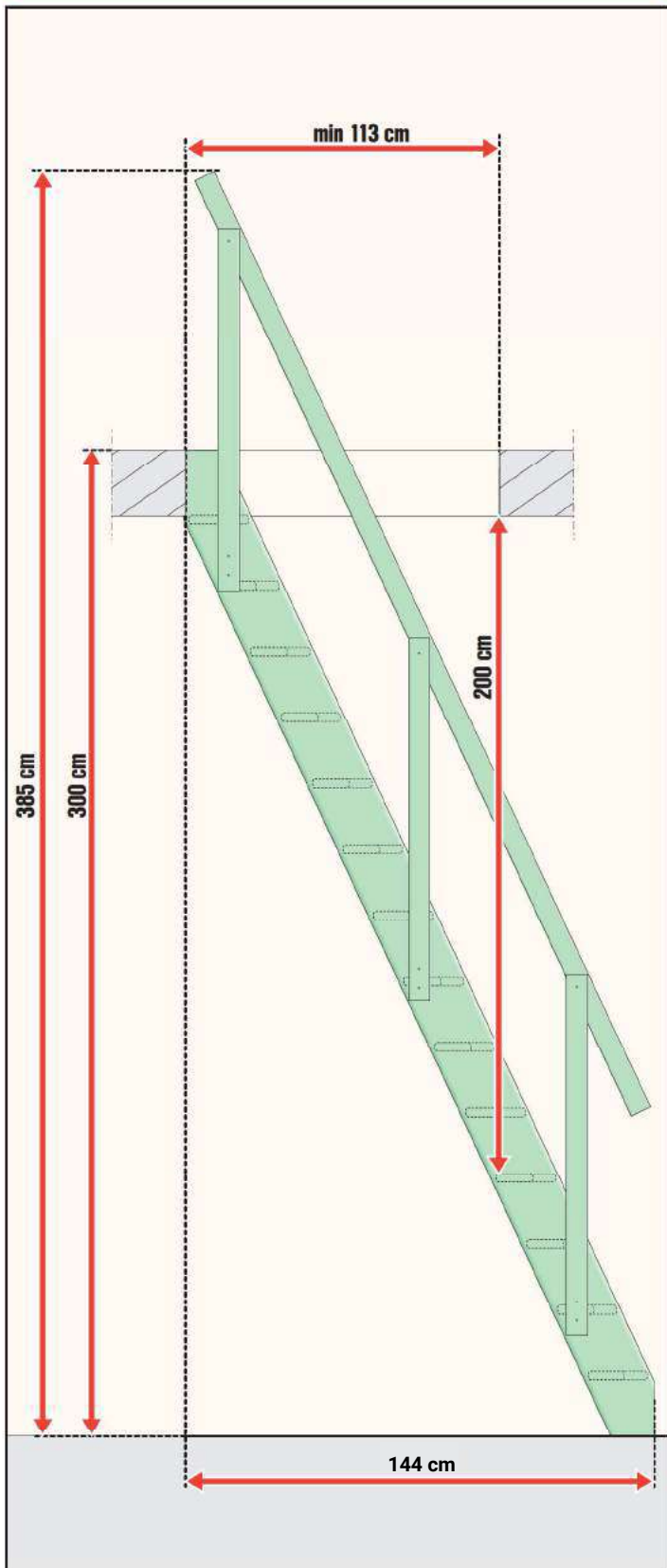
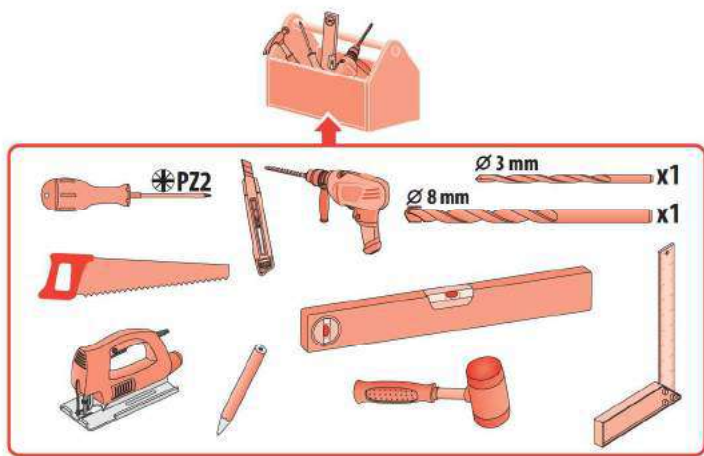

2

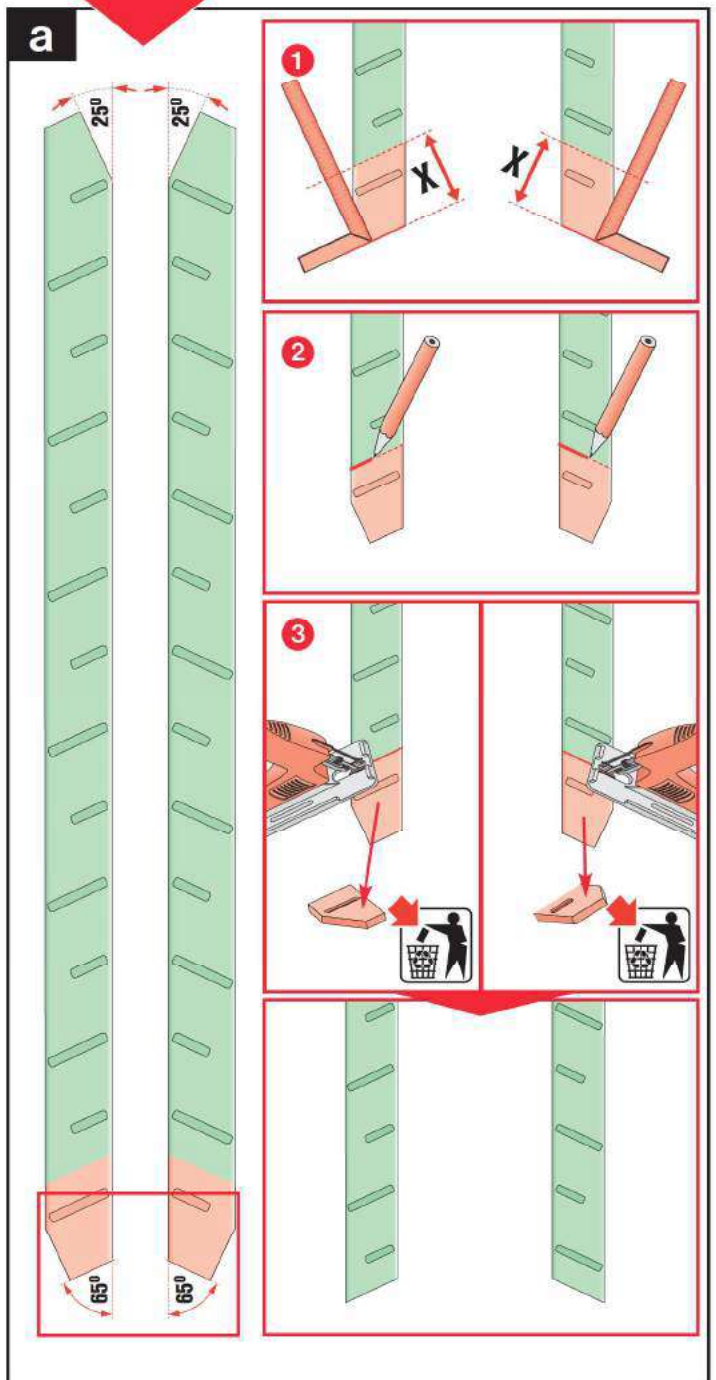
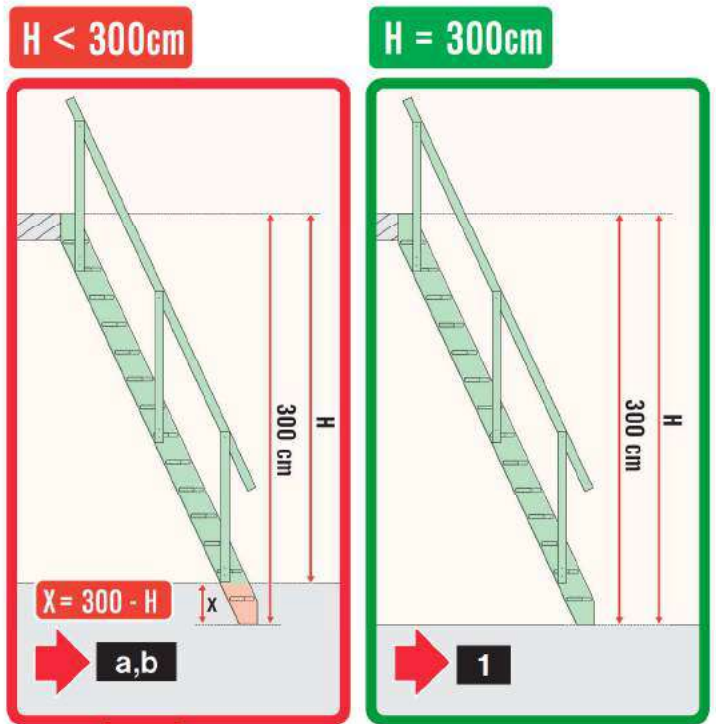

3



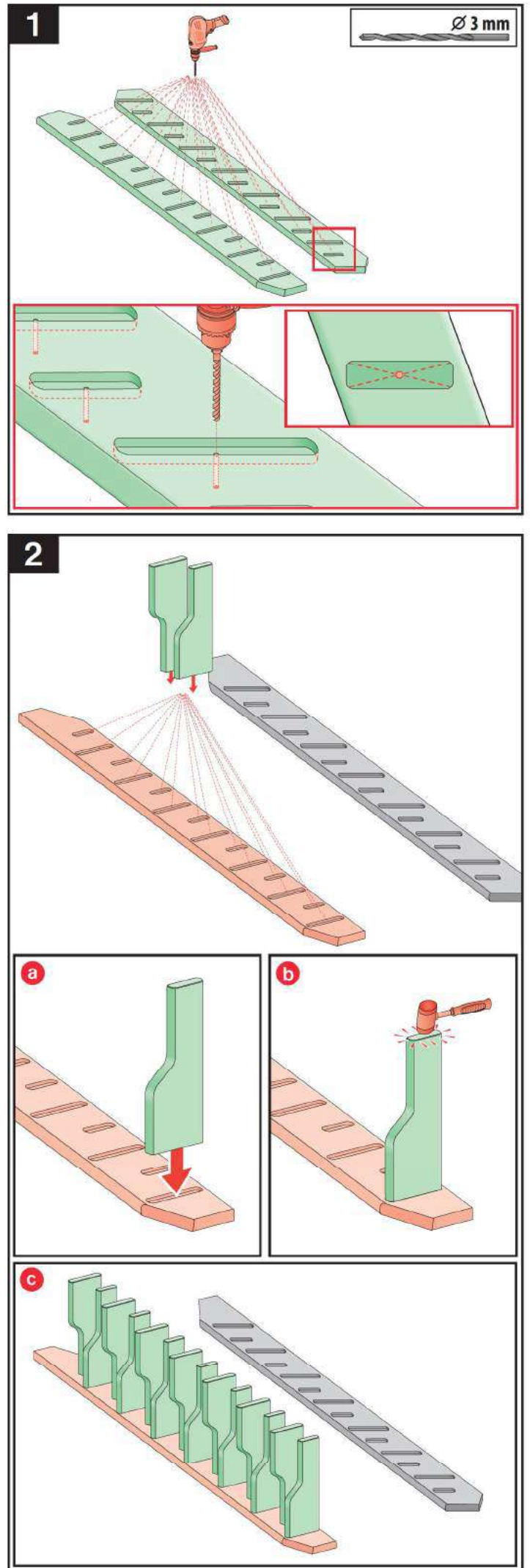
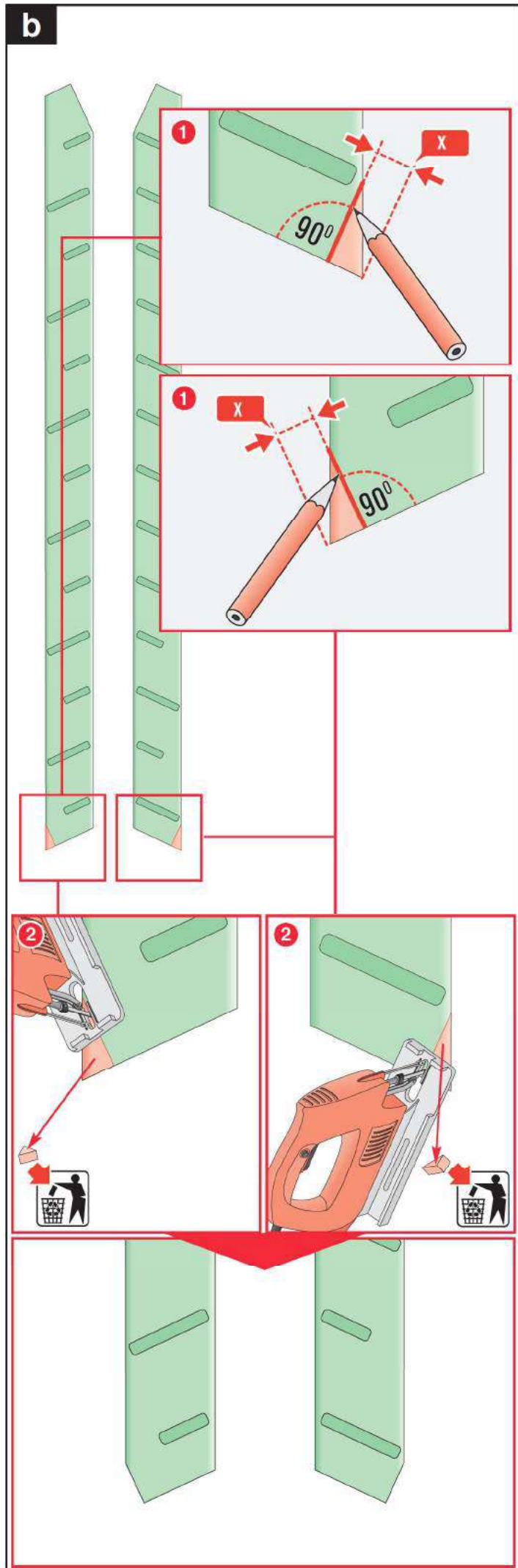

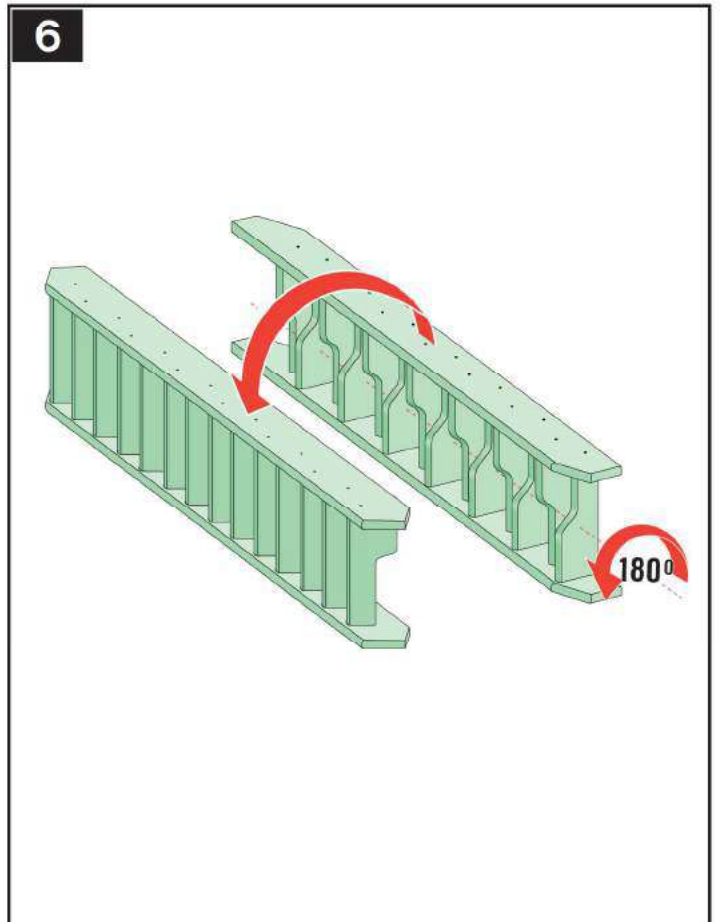
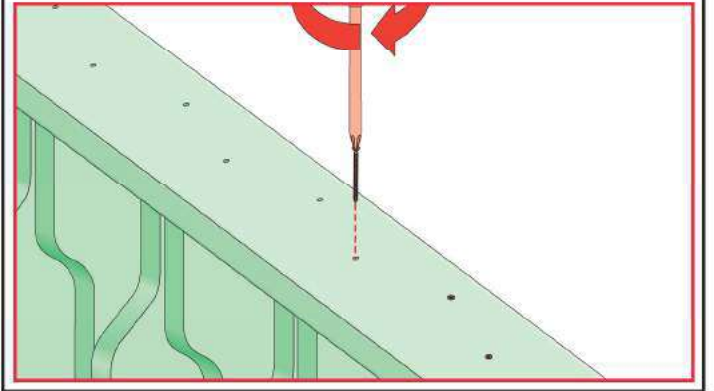
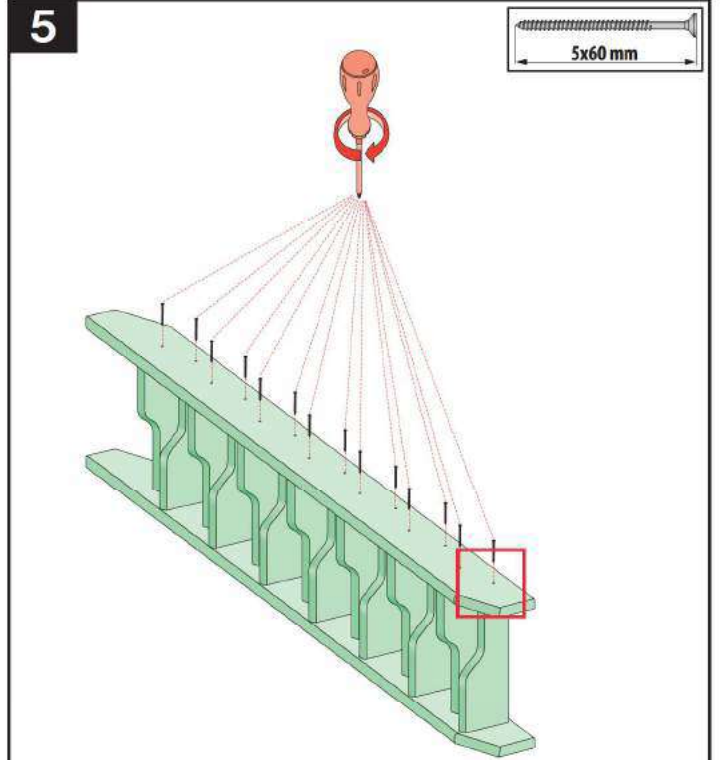
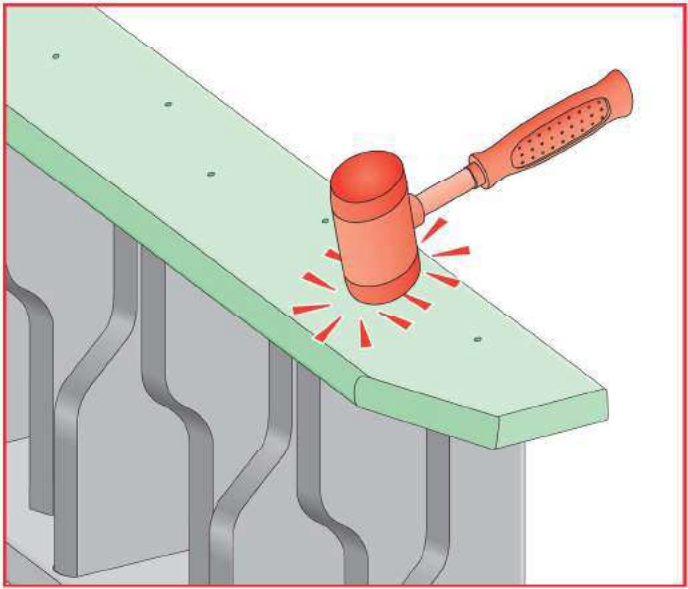
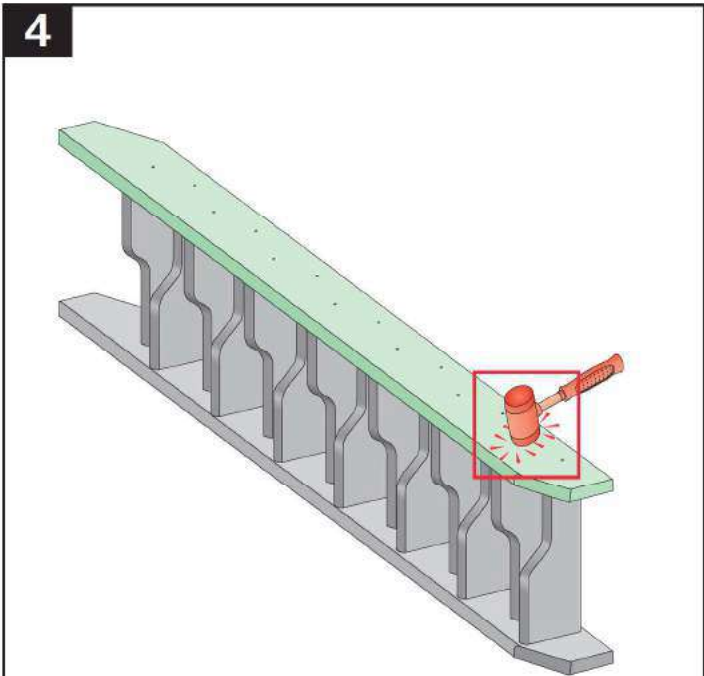
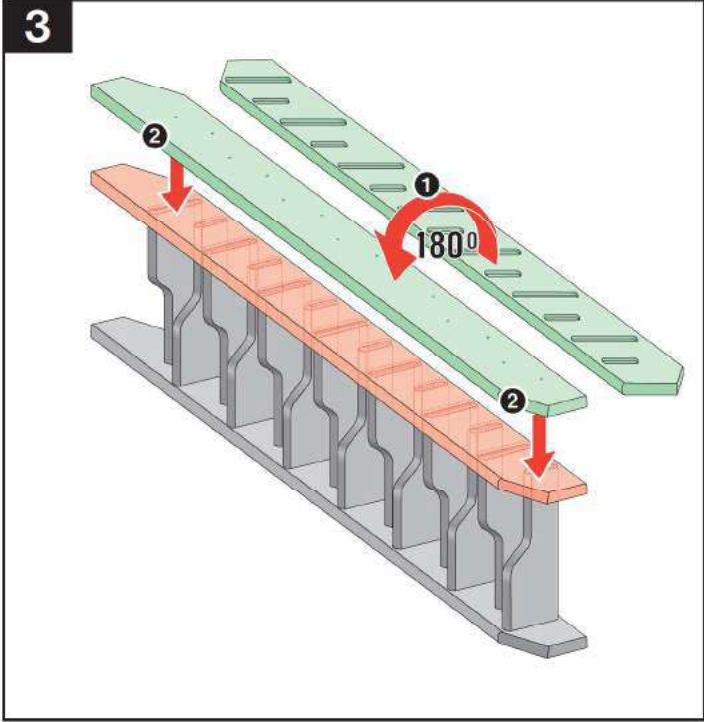



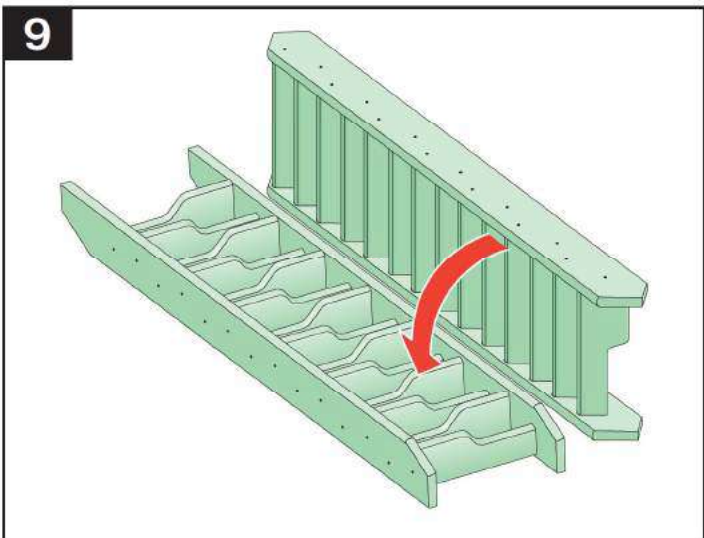
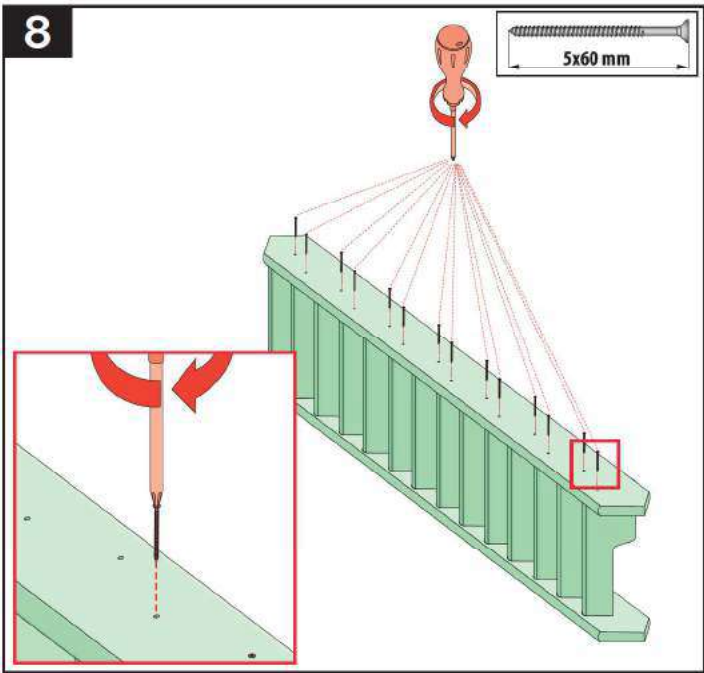
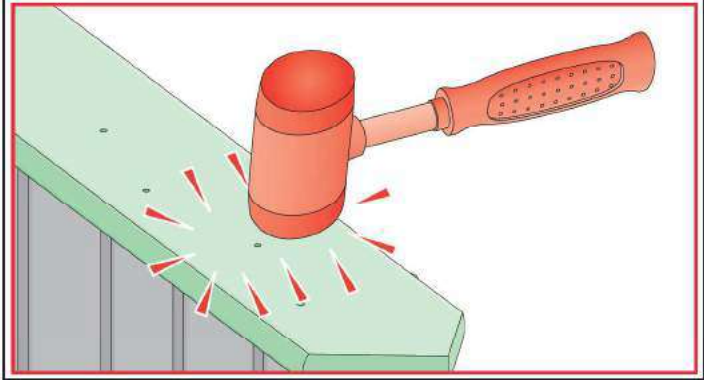
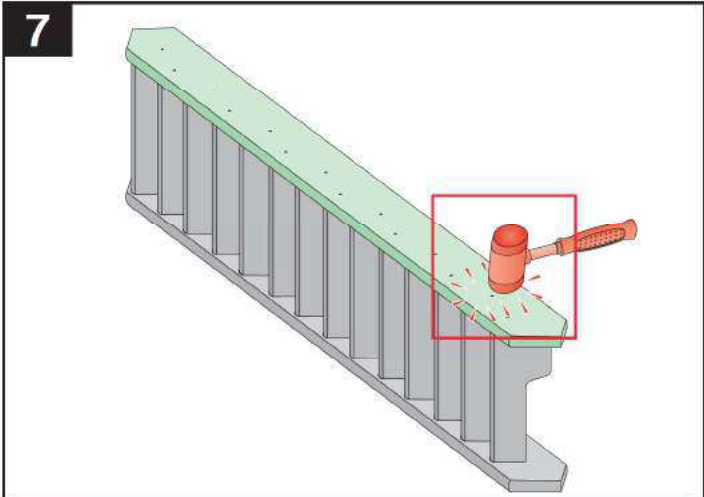

8

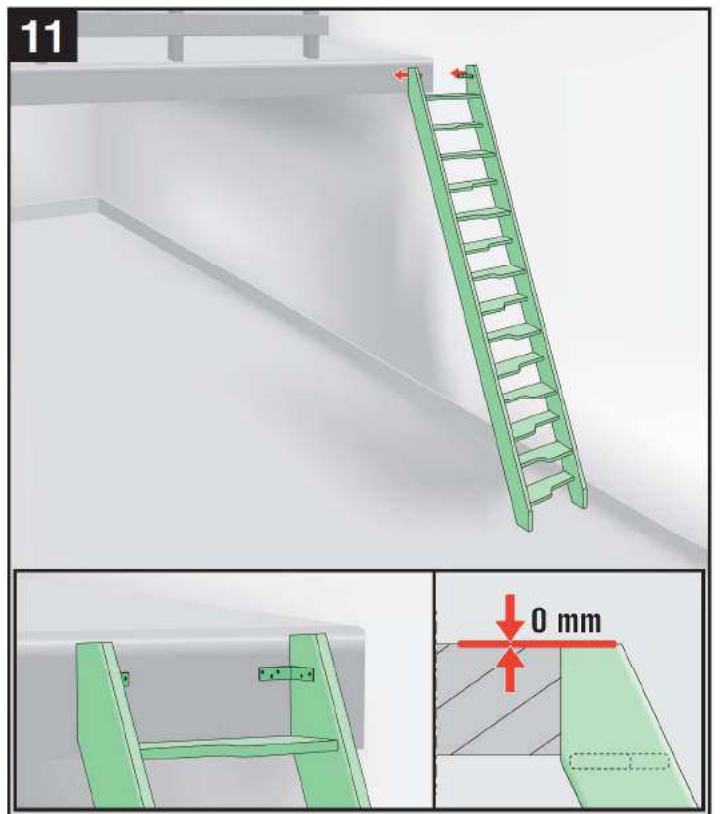
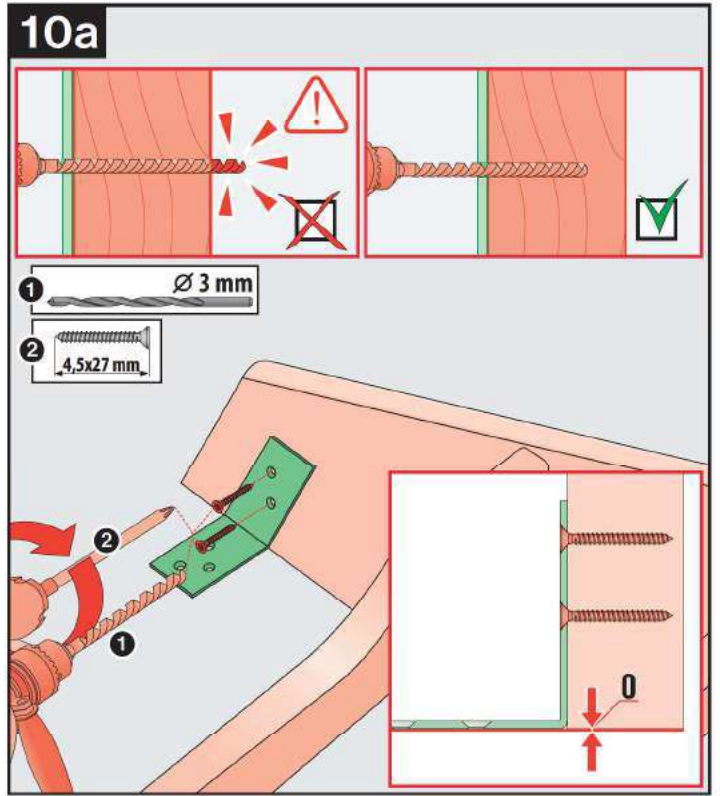
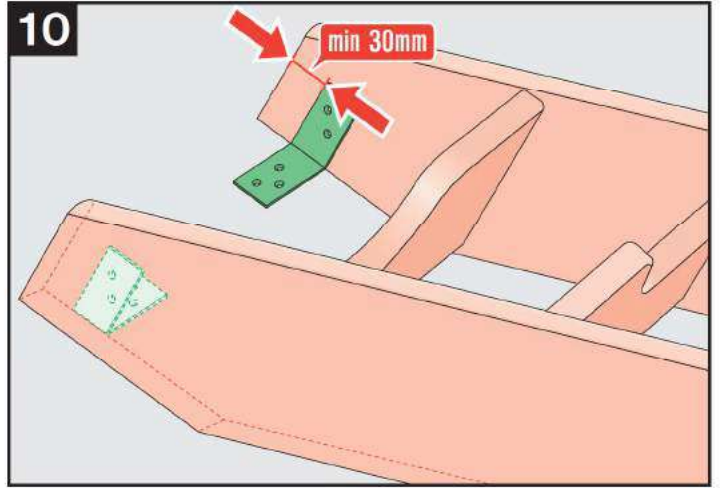

9

