

A

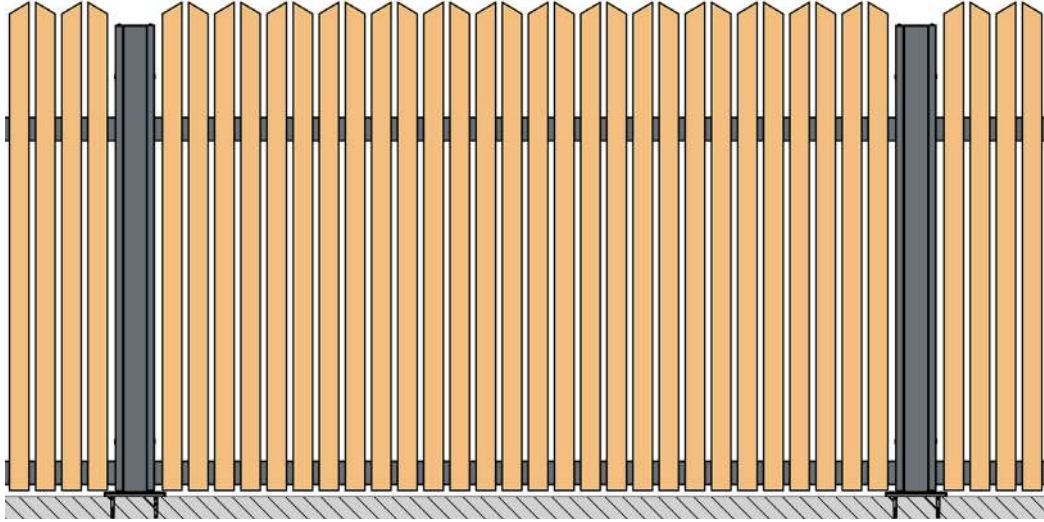

B

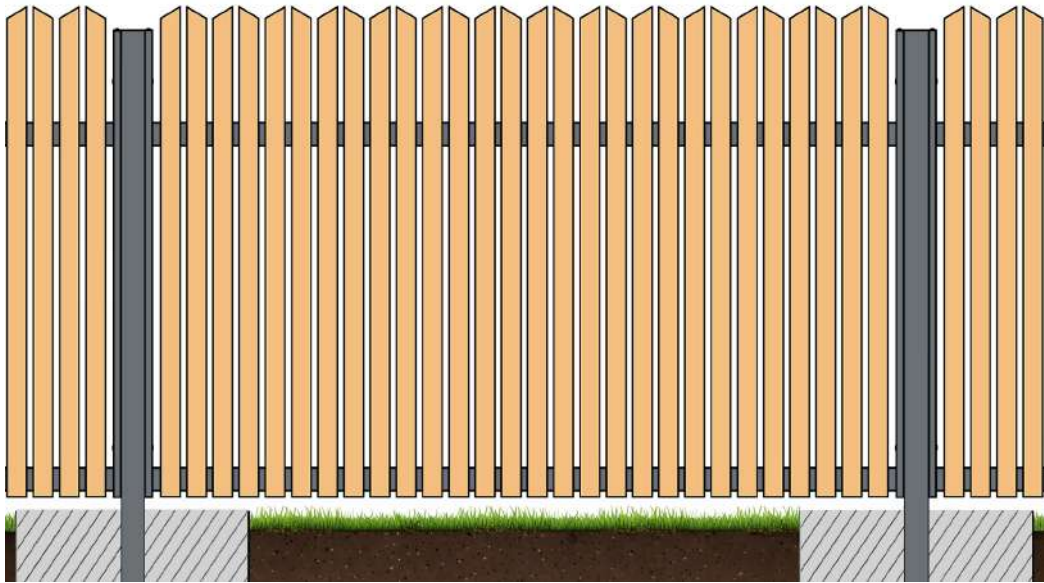

C

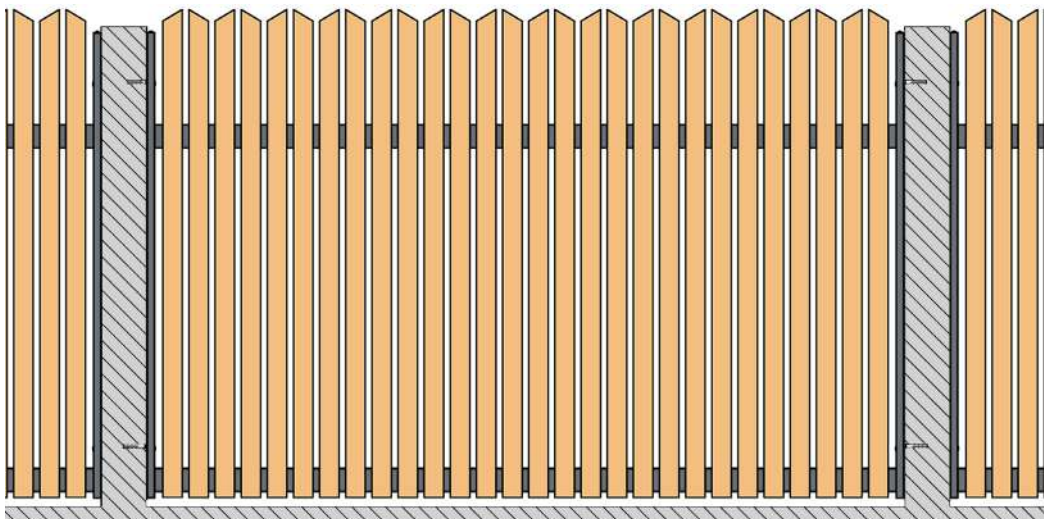

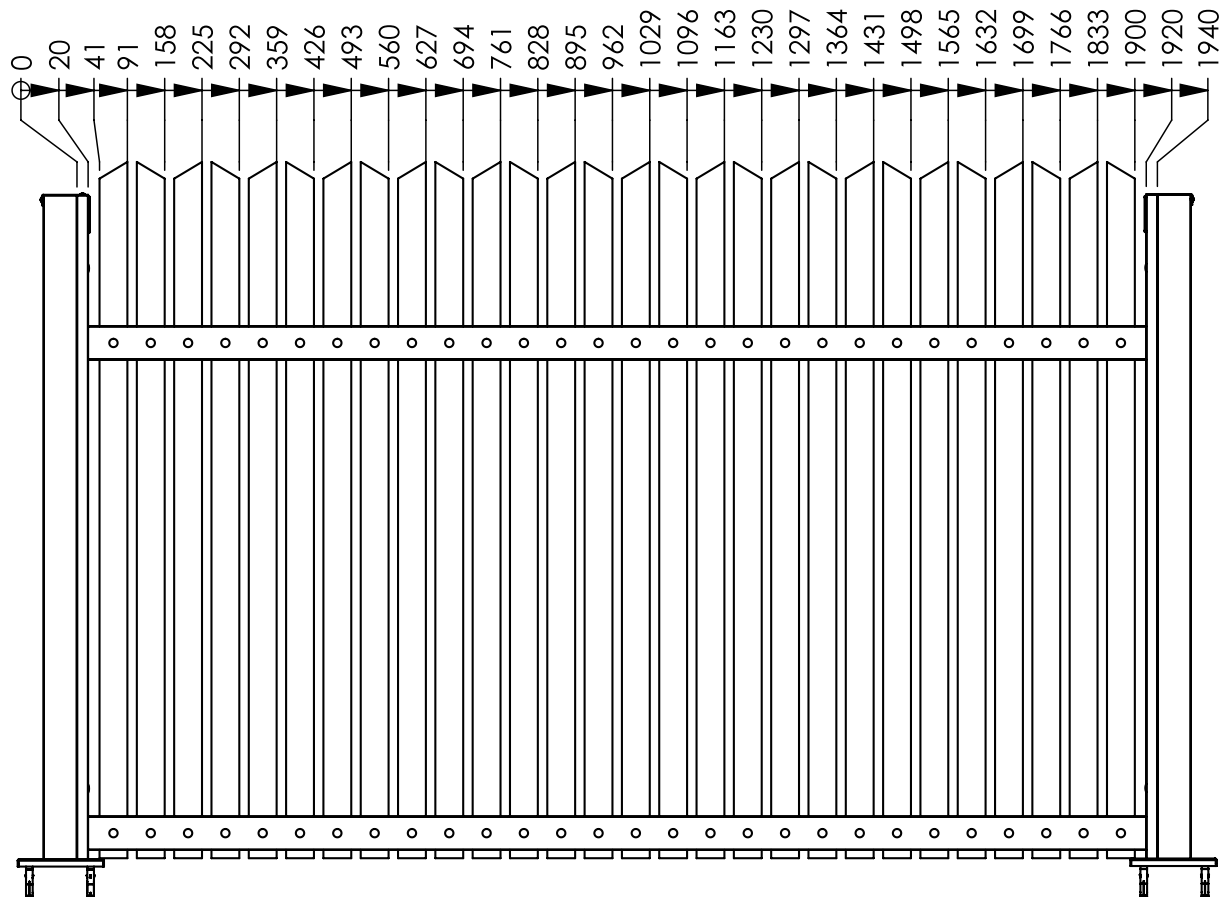
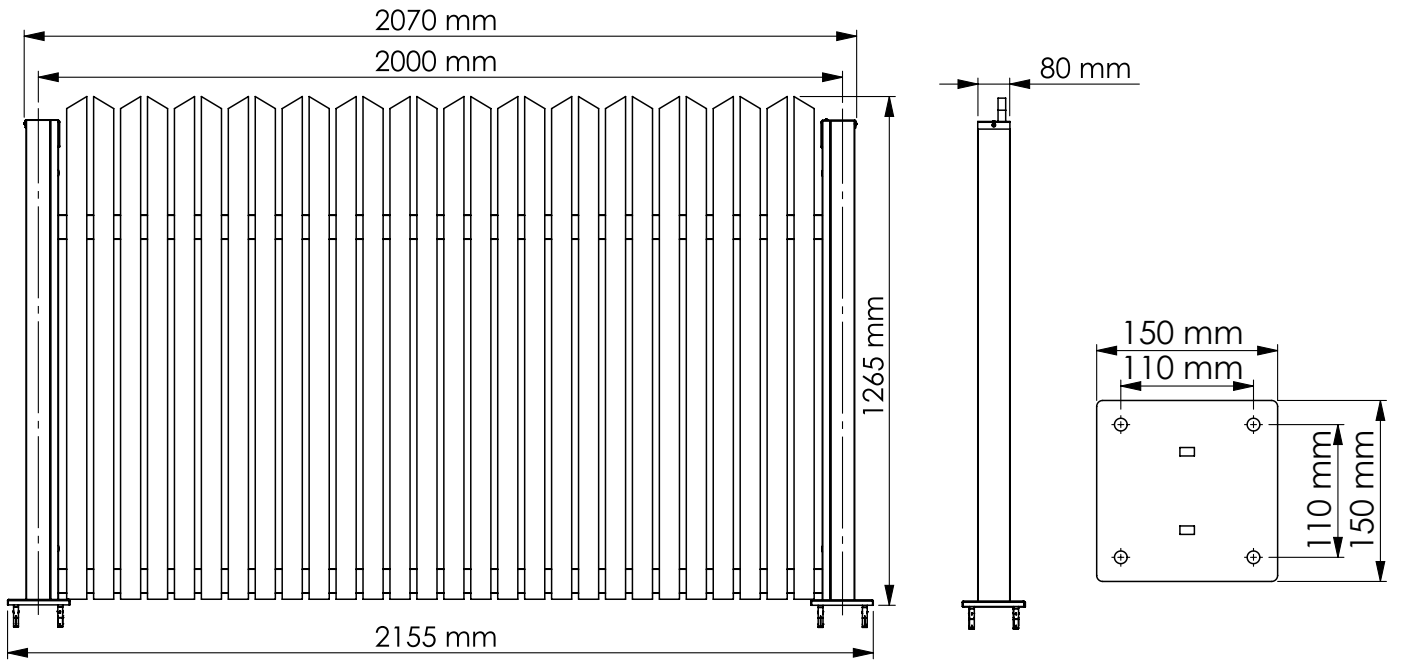

8x

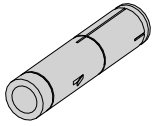

D01

M8x55 mm

60x

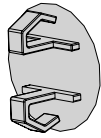

KS09

Ø13mm

2x

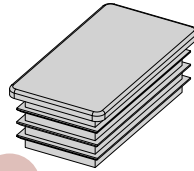

KS22

35x65 mm

8x

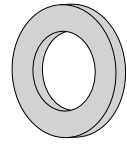

NT26

M8 DIN125A

12x

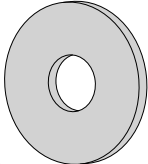

NT39

M8 DIN9021

8x

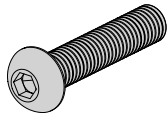

NT47

M8x60 mm ISO7380-1

6x

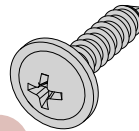

NT77

Ø3,5x16 mm

4x

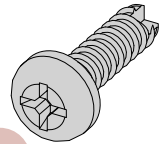

NT79

Ø5,5x22 mm

56x

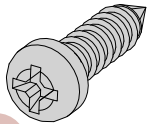

NT85

4x16 mm

2x

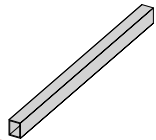

ZT01

80x60x1200 mm

2x

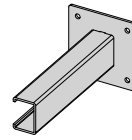

ZT02

2x

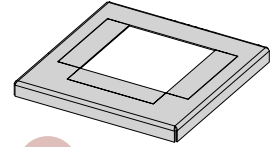

ZT03

2x

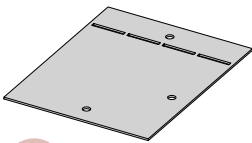

ZT04

2x

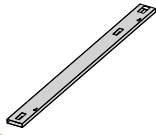

ZT06

80x20x1200 mm

2x

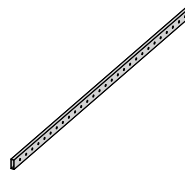

ZT16

60x20x1940 mm

28x

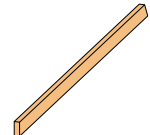

ZT17

50x19x1250 mm

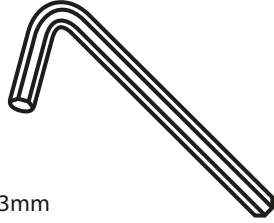
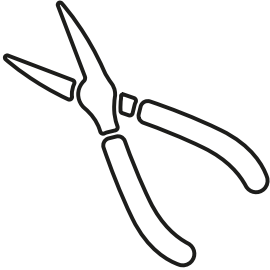

3mm  
5mm

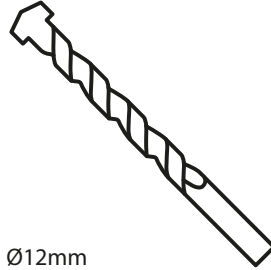

Ø12mm

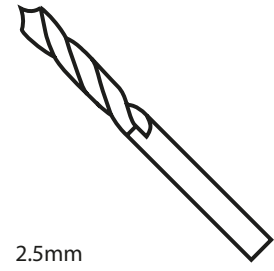
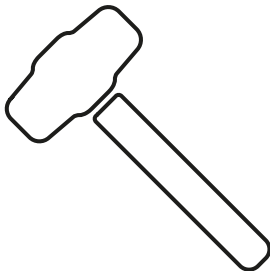
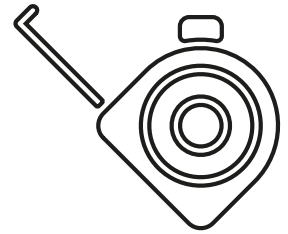
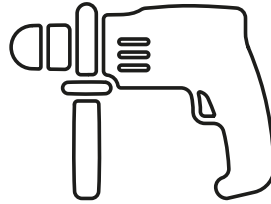
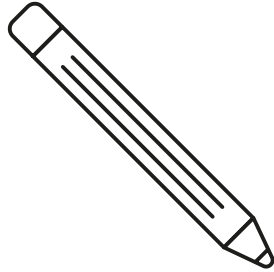
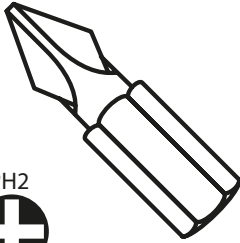
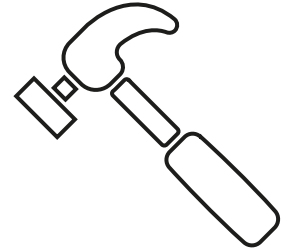

2.5mm

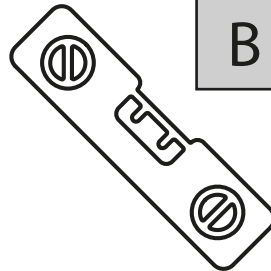

B

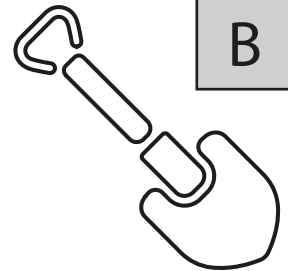

B



B

4x



min. Ø5x60 mm

C

4x

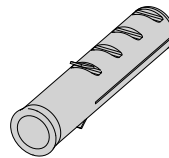

C

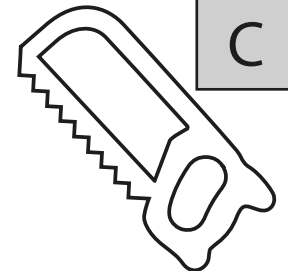

C

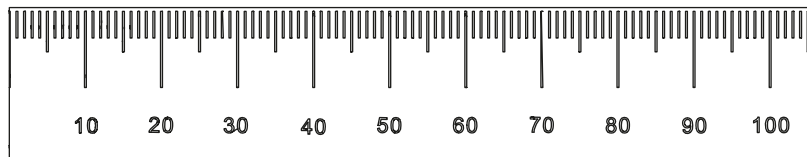

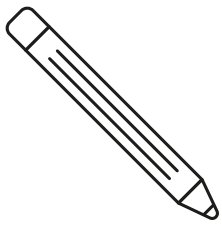

5mm

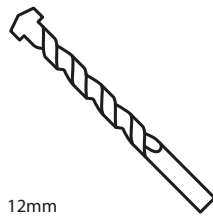
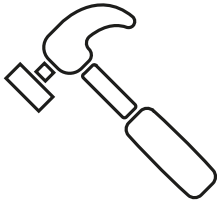

12mm

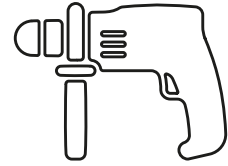

1

A

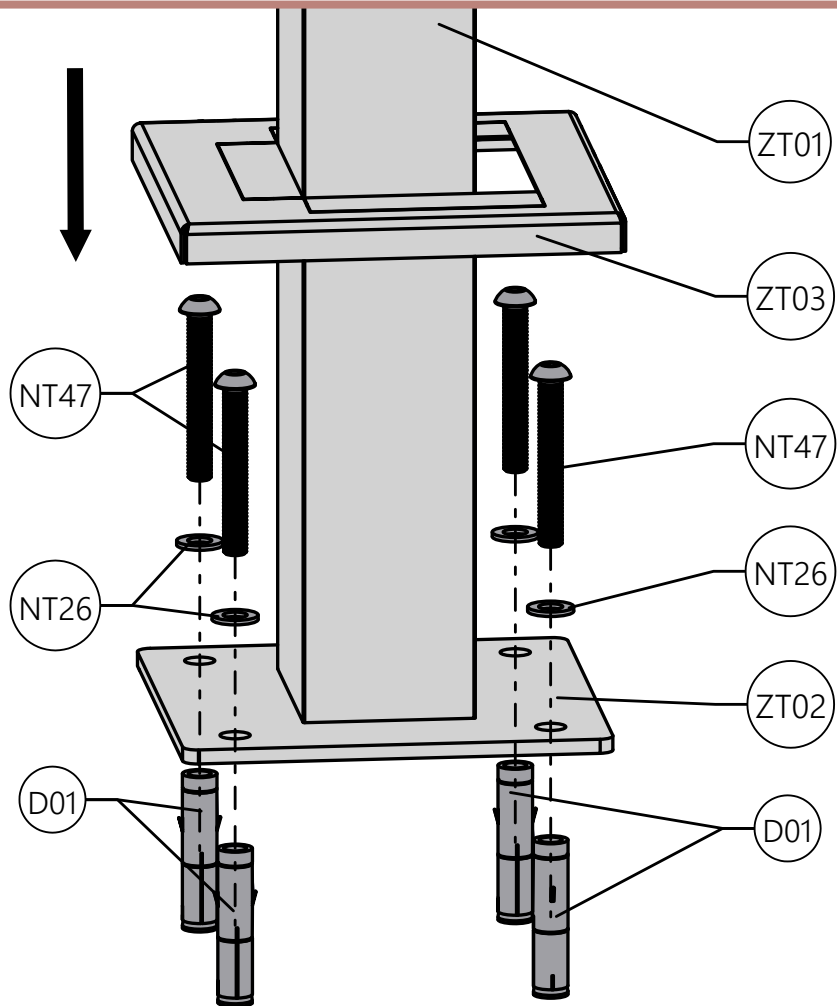
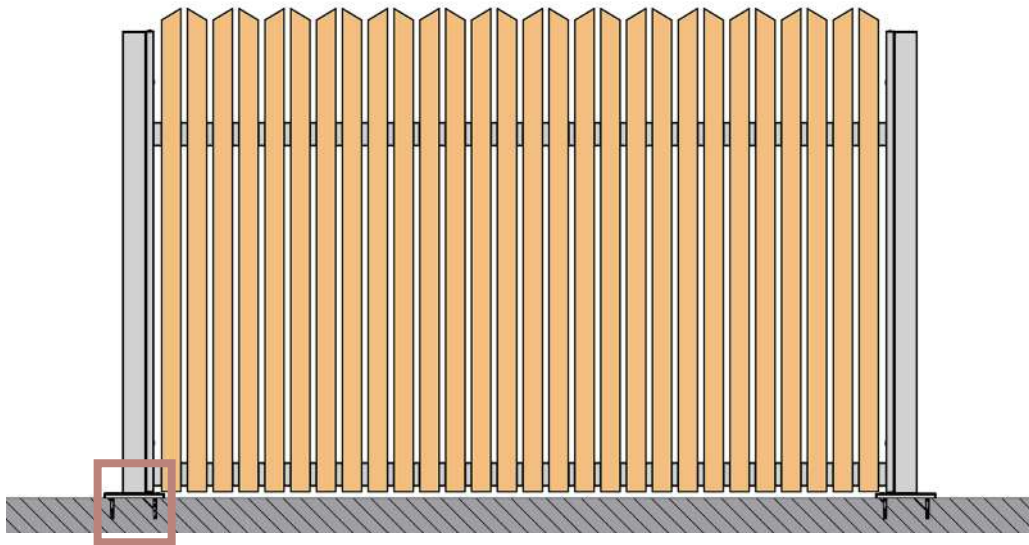

2

B

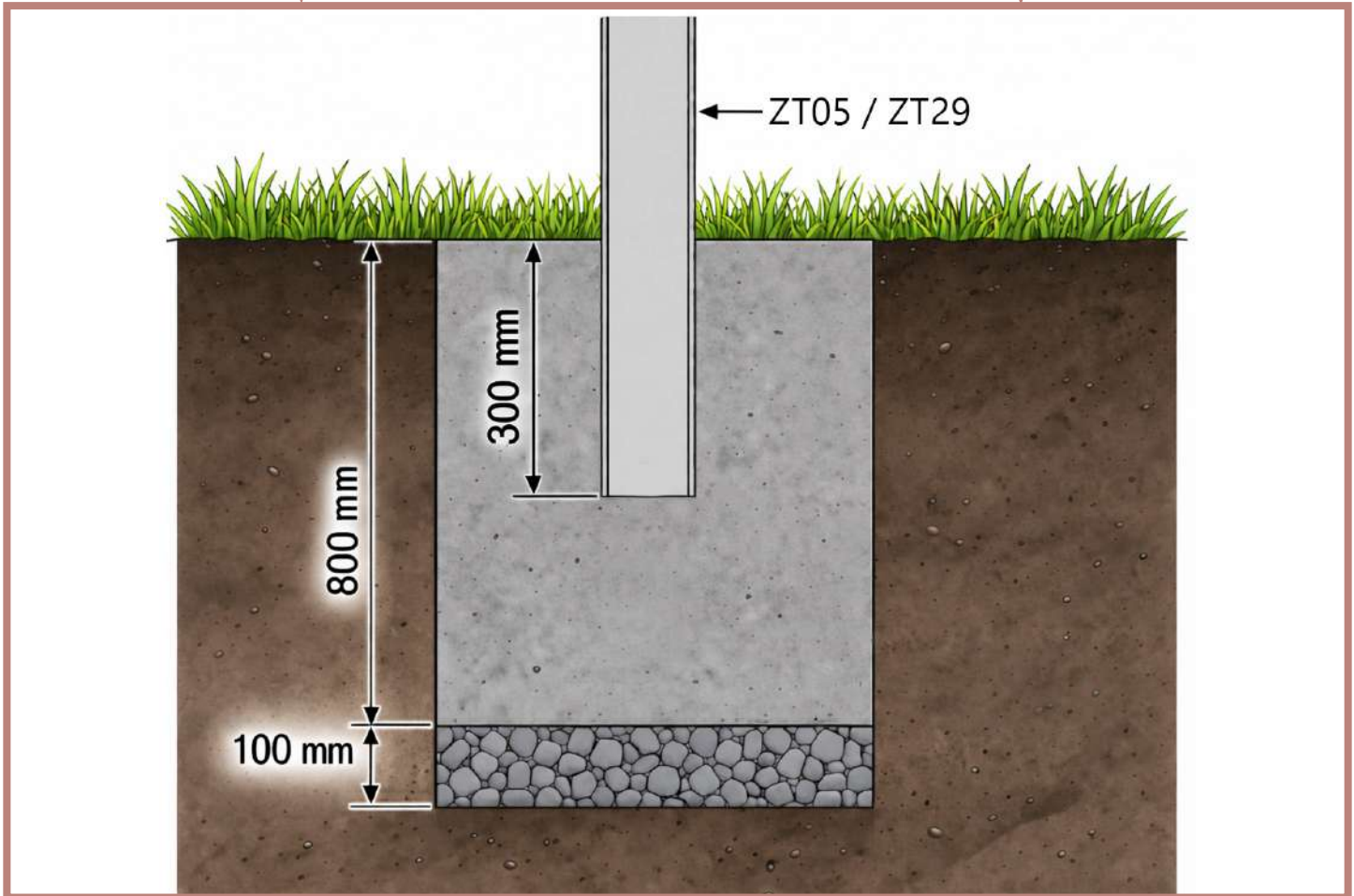
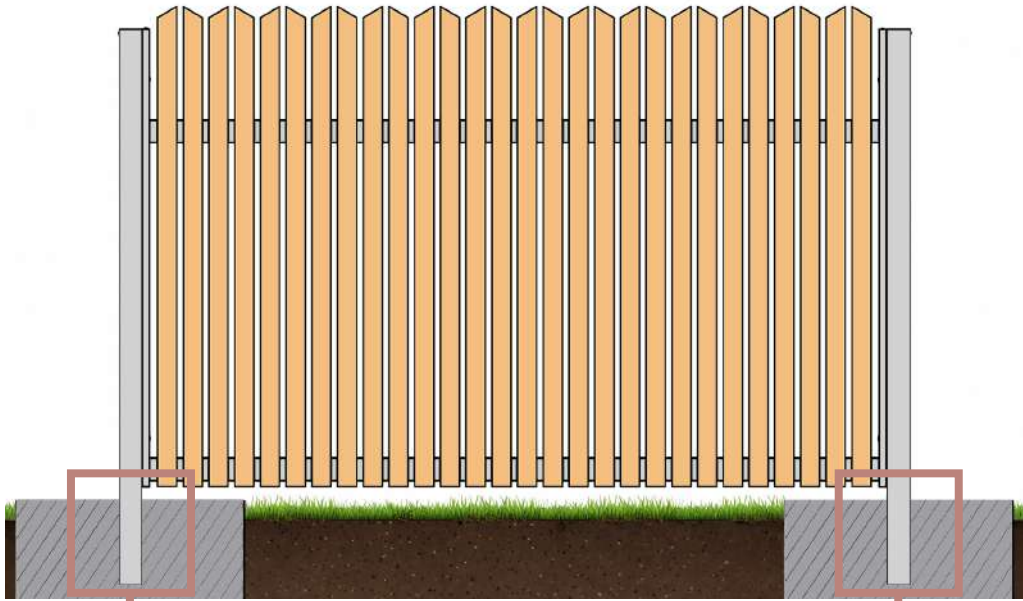
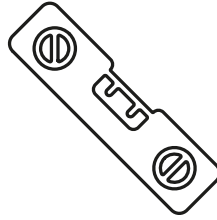
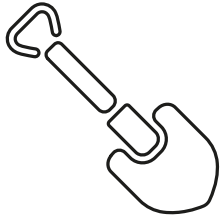

3

C

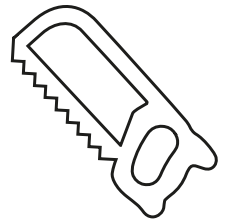
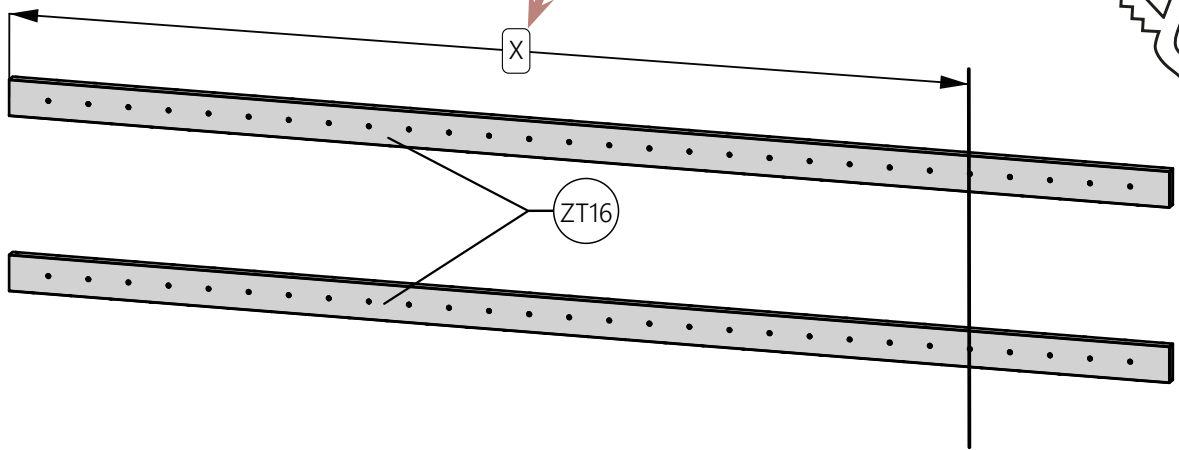
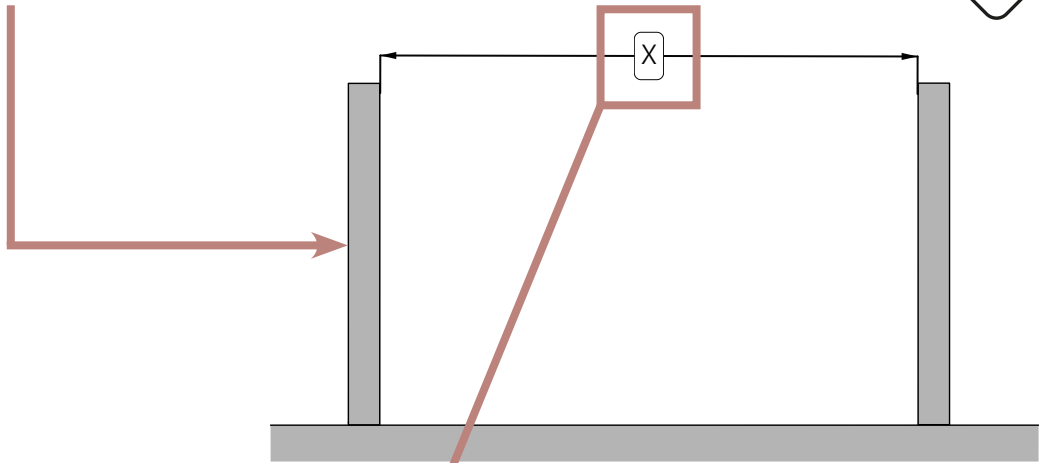
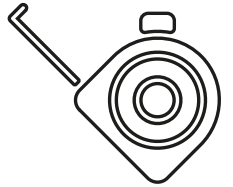
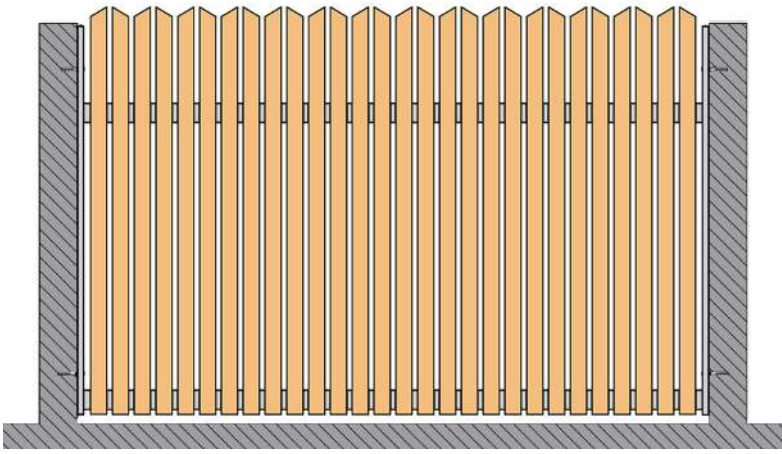

4

A

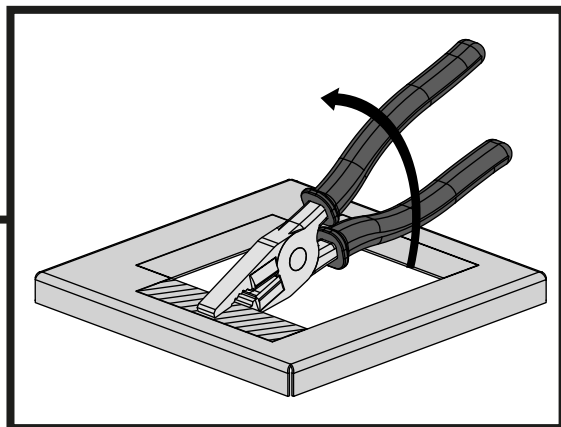
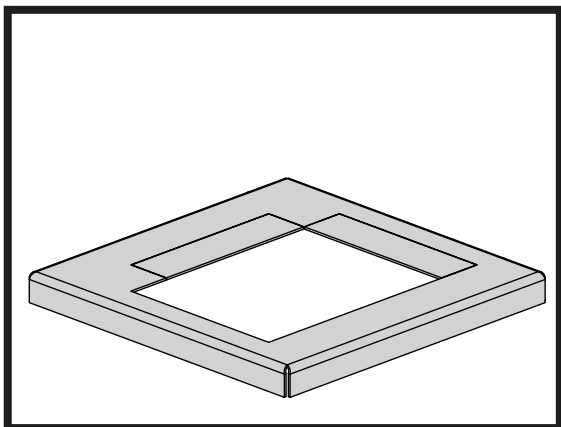
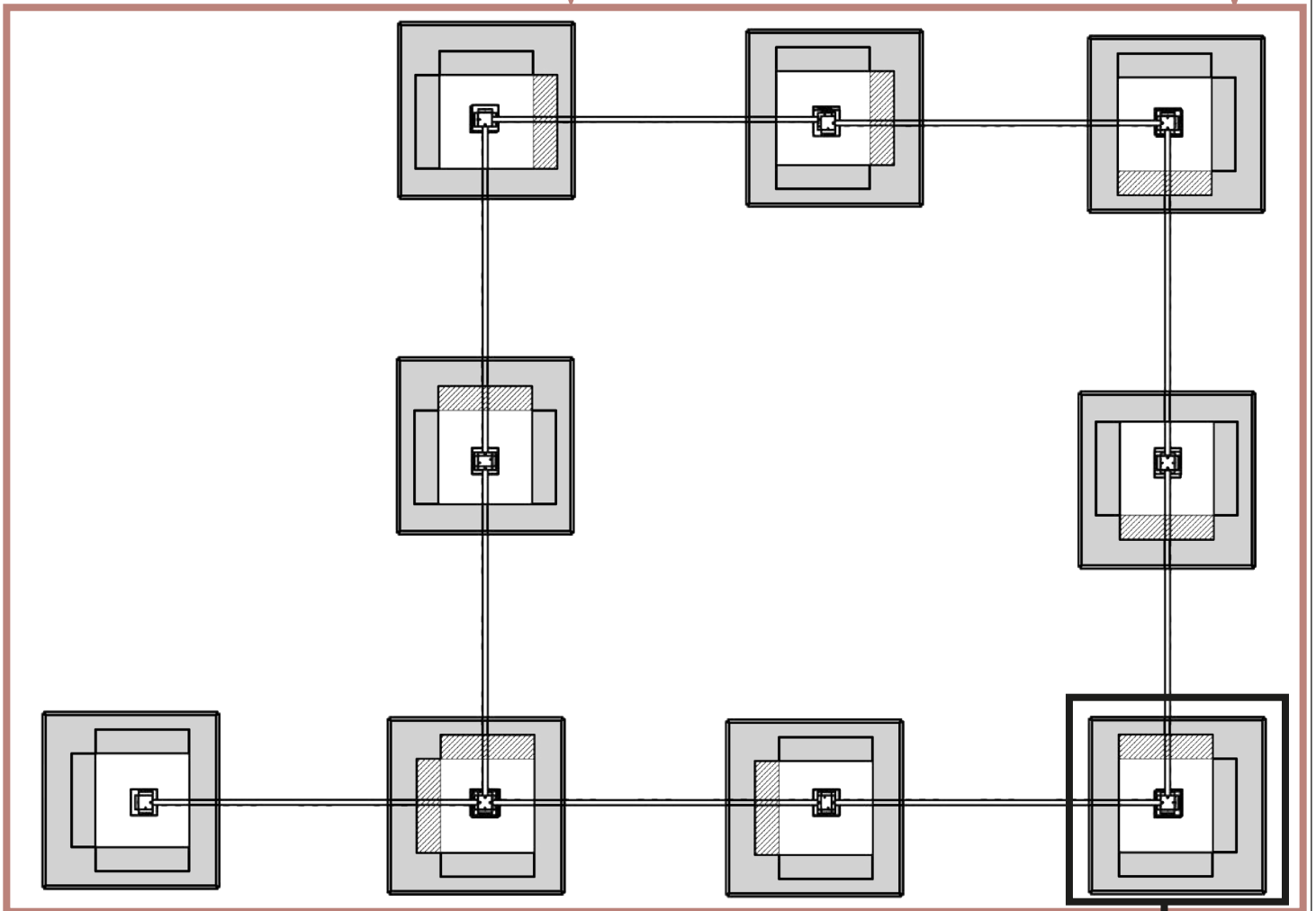
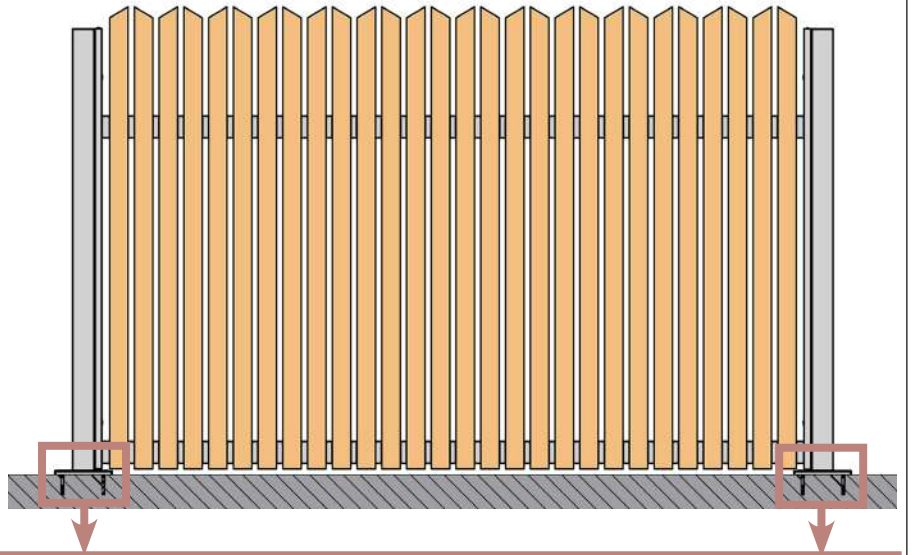

5

A

B

C

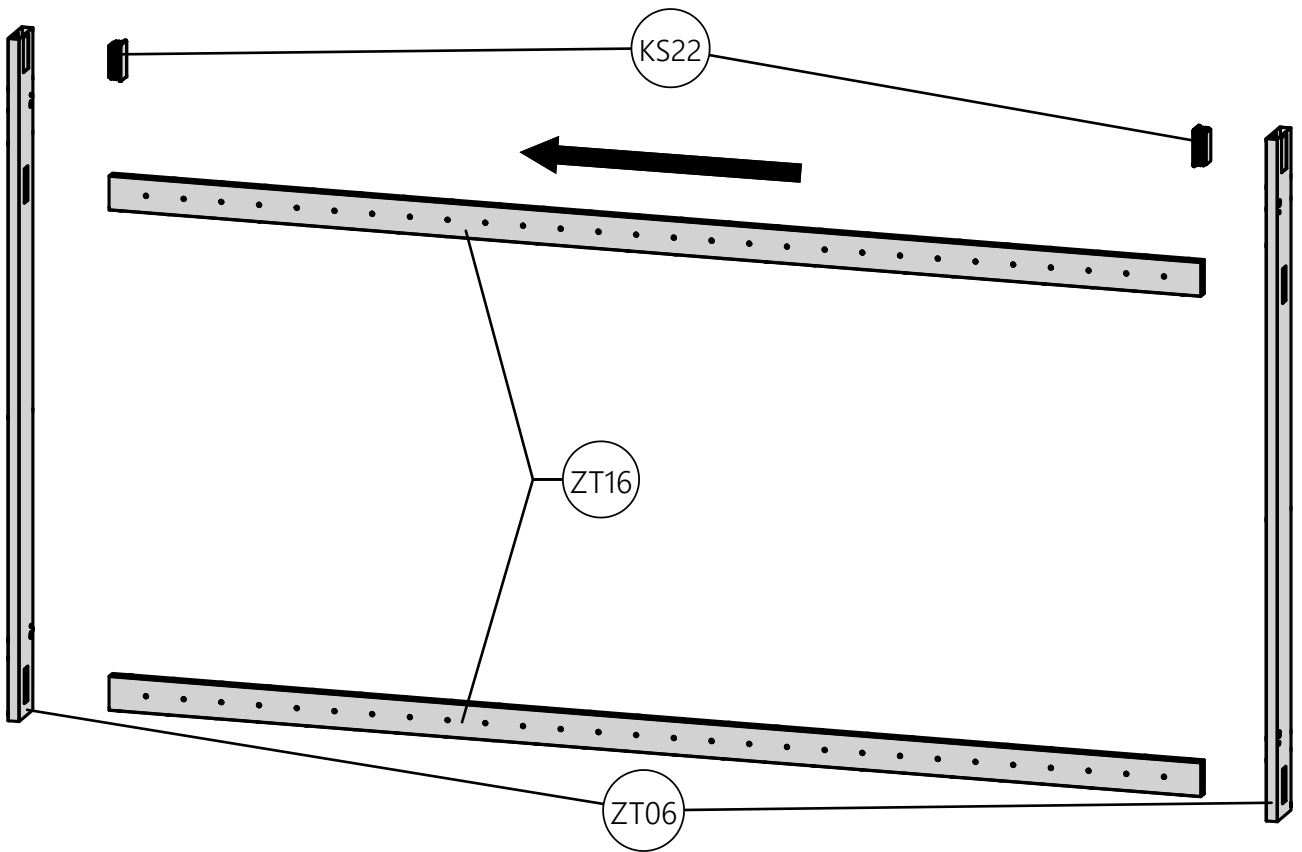
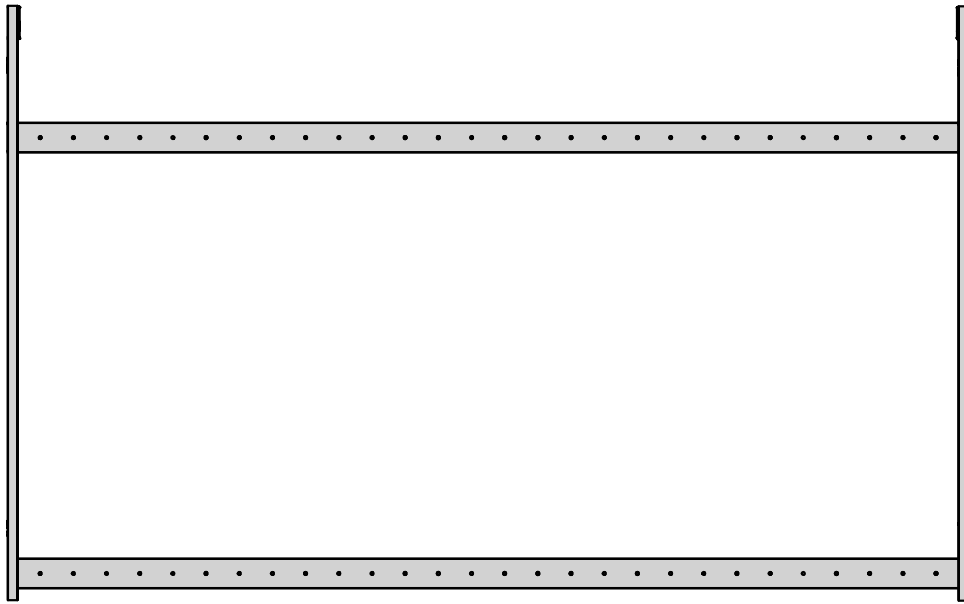
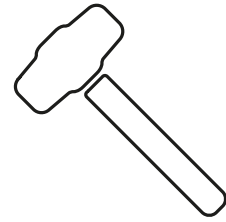

6

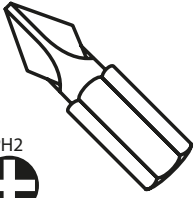

A

B

C

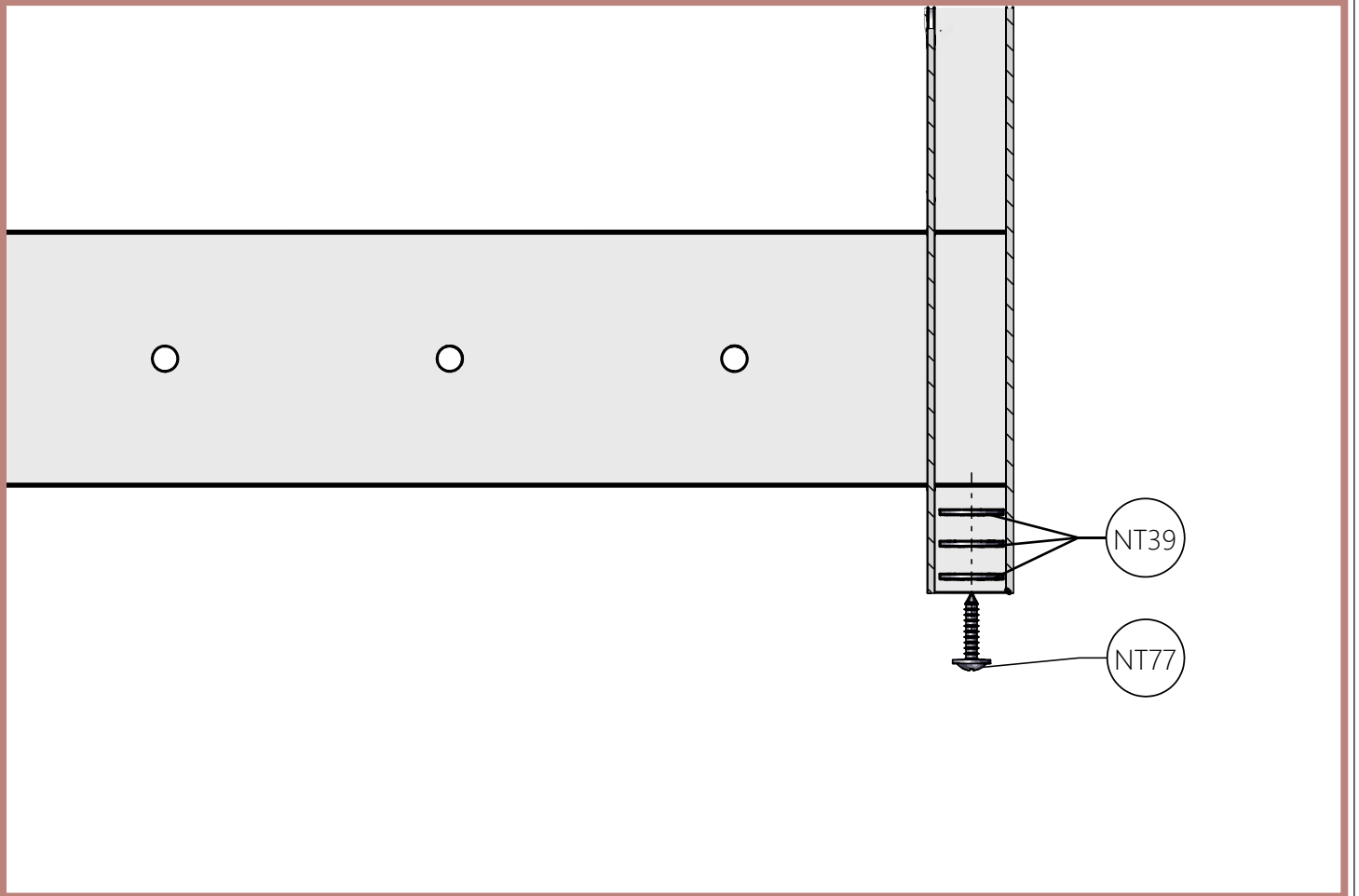
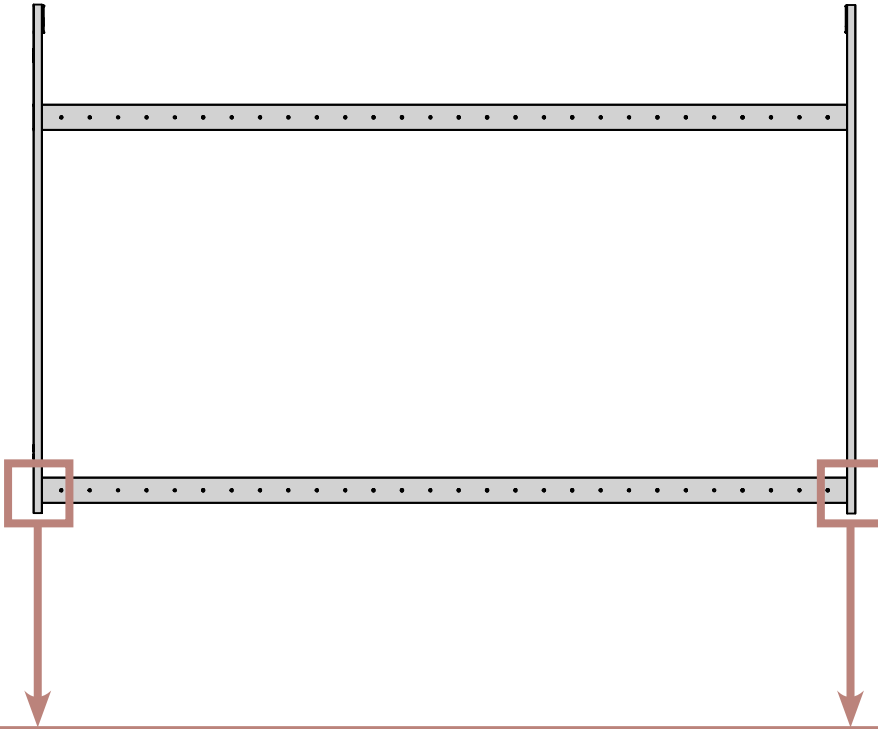

NT39

NT77

7

A

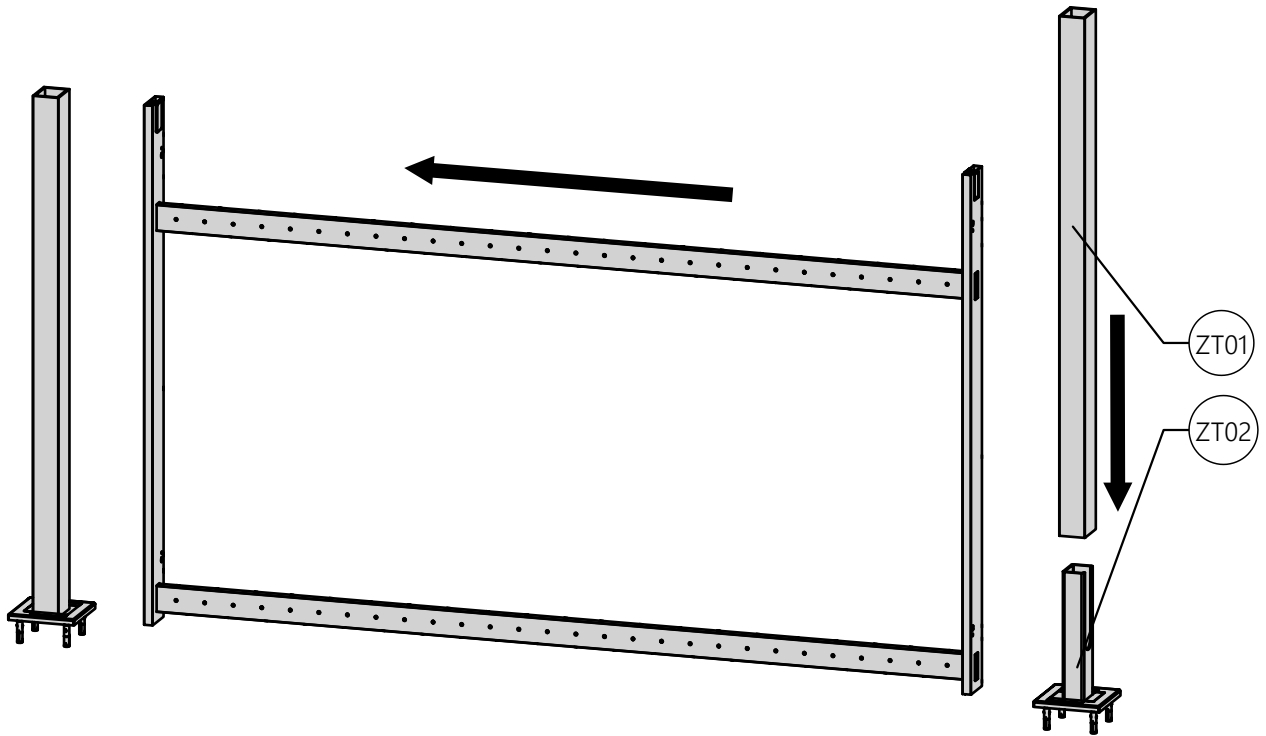
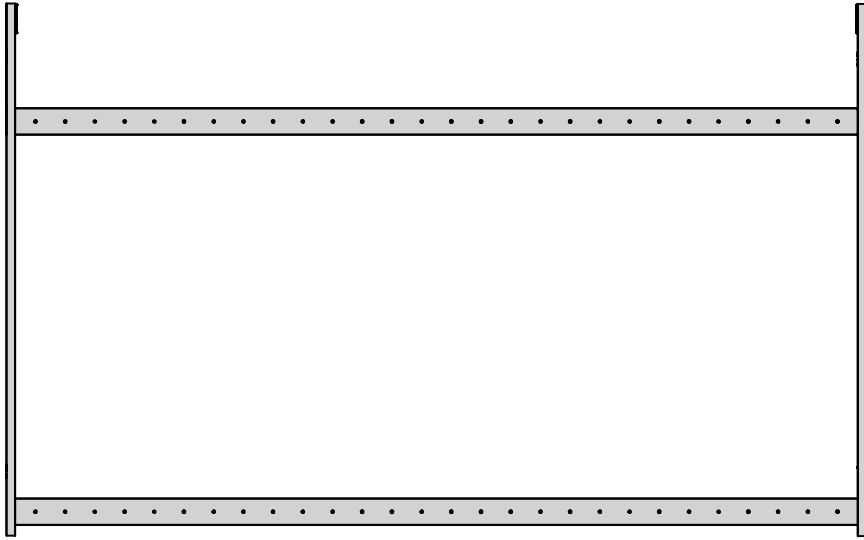

8

A

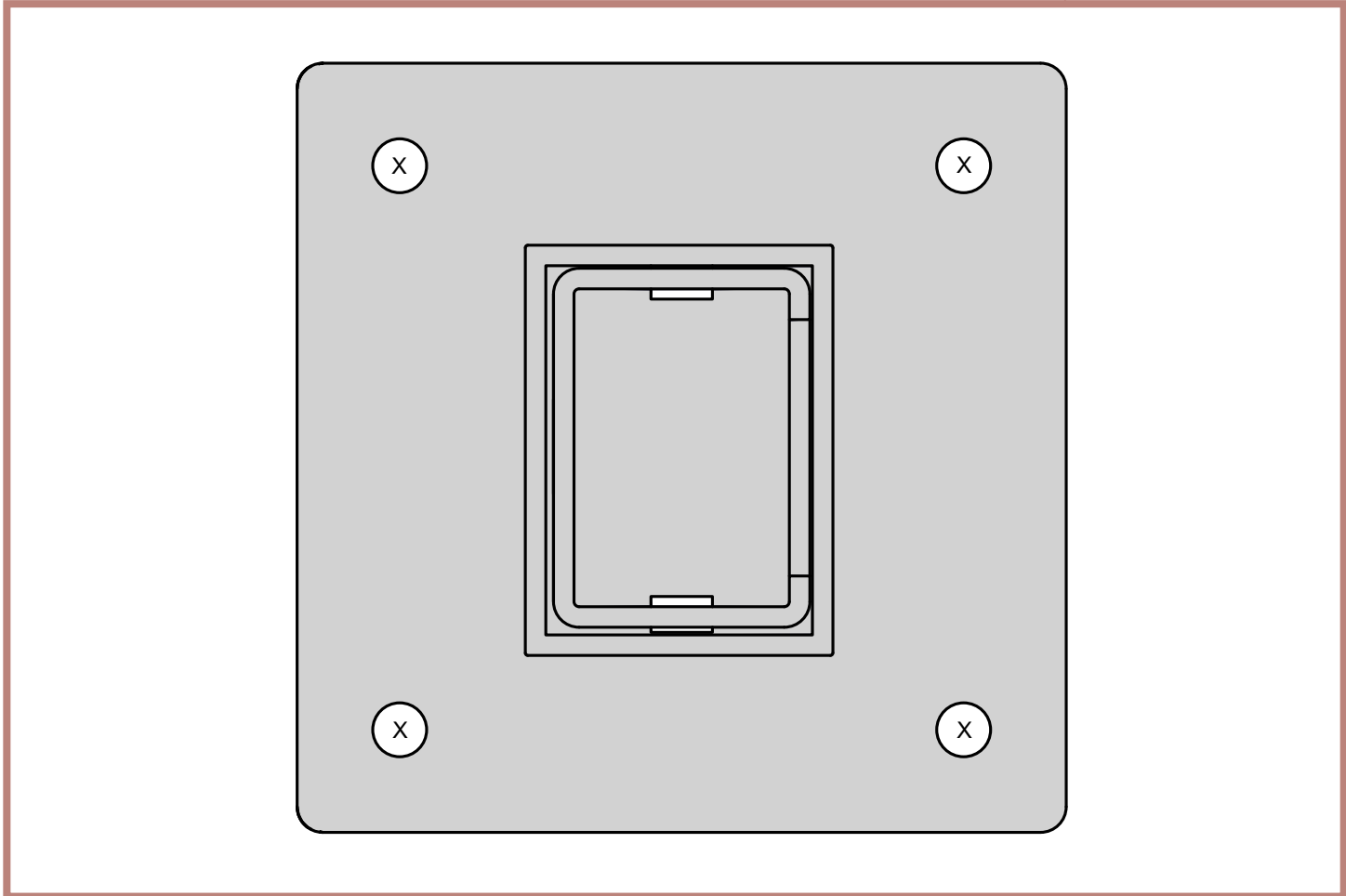
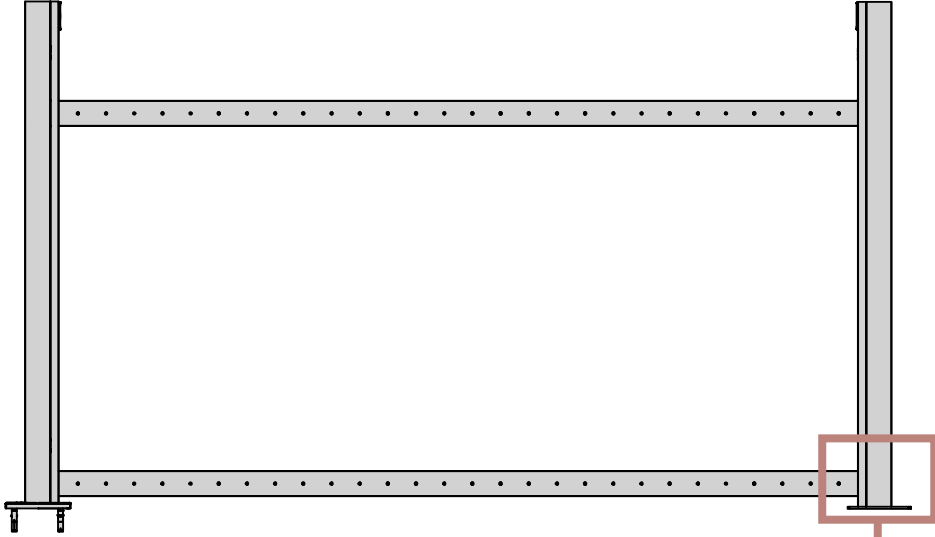
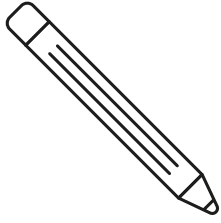

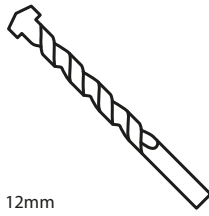
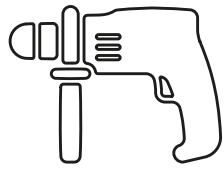

12mm

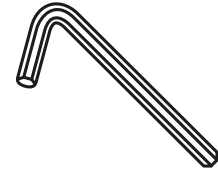
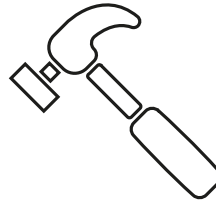

5mm

9

A

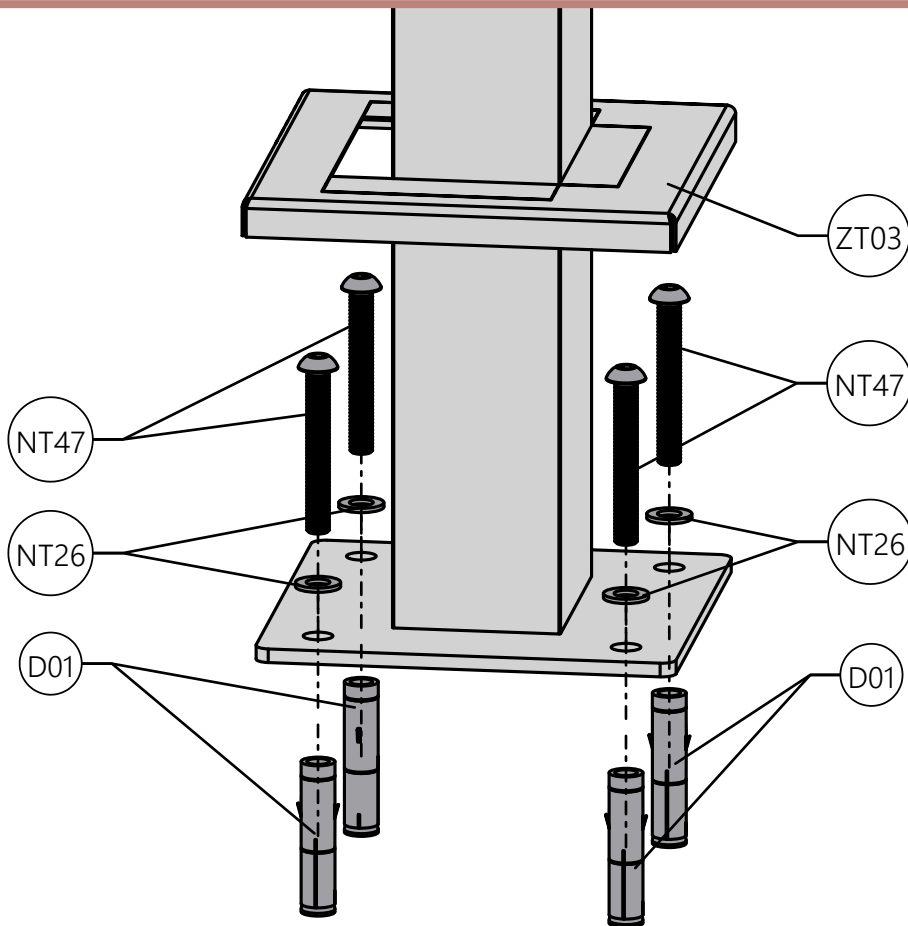
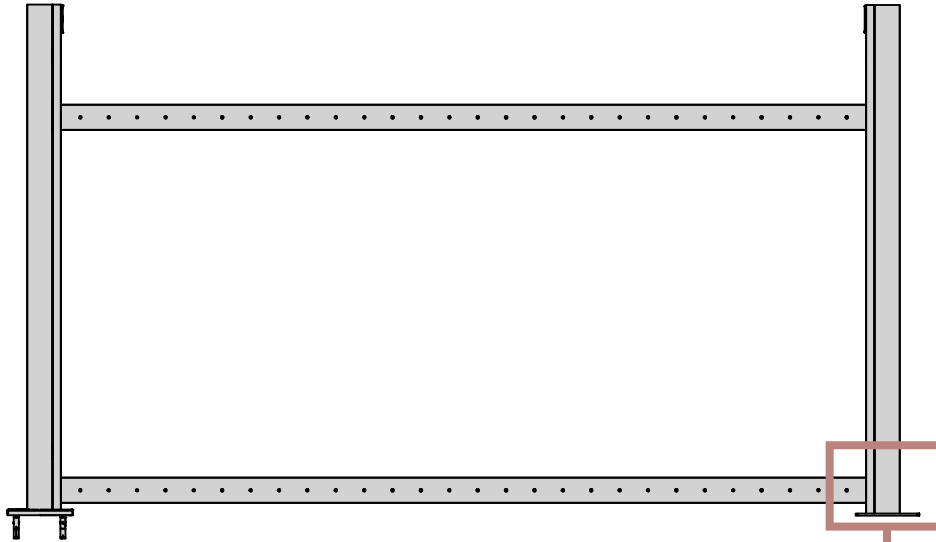

10

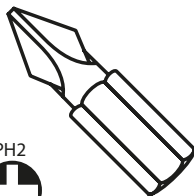

A

B

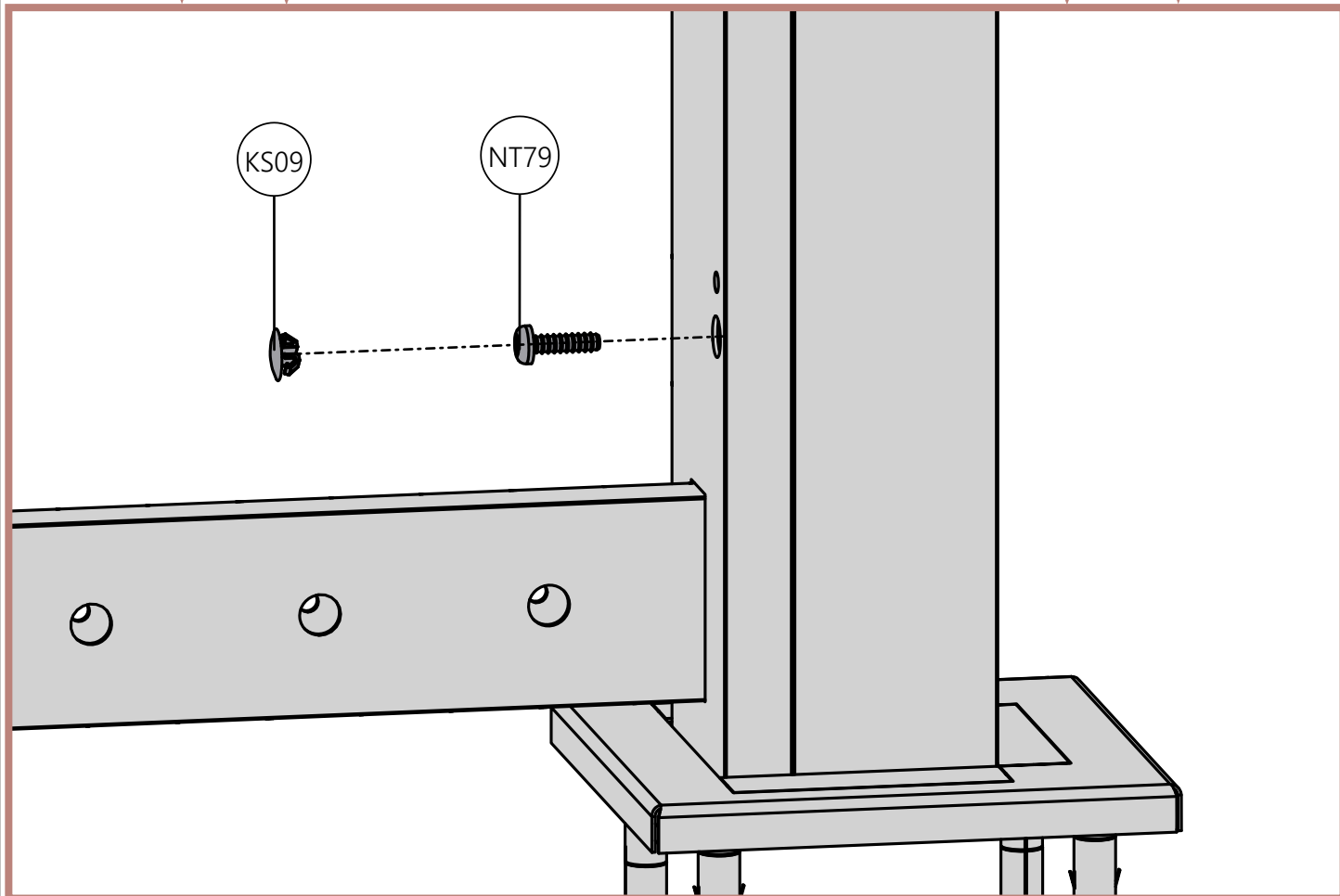
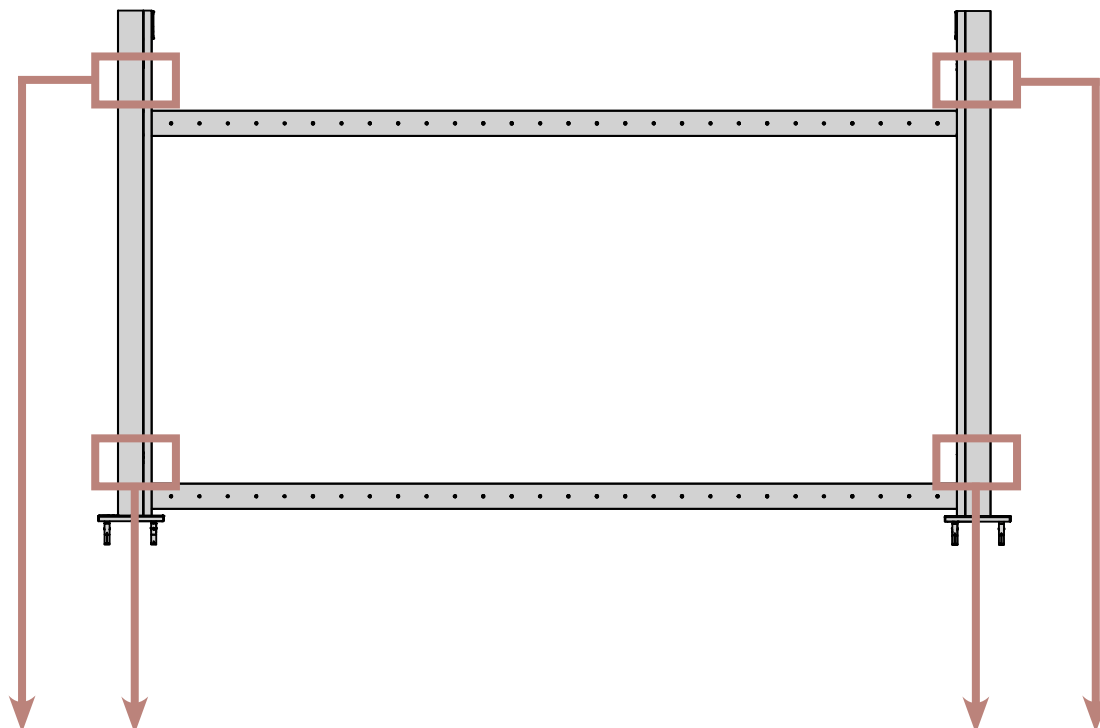

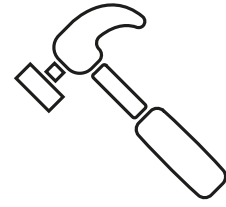
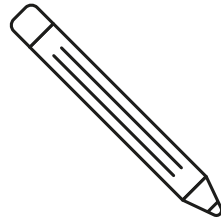
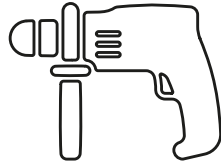
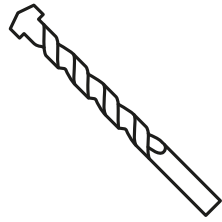

11

C

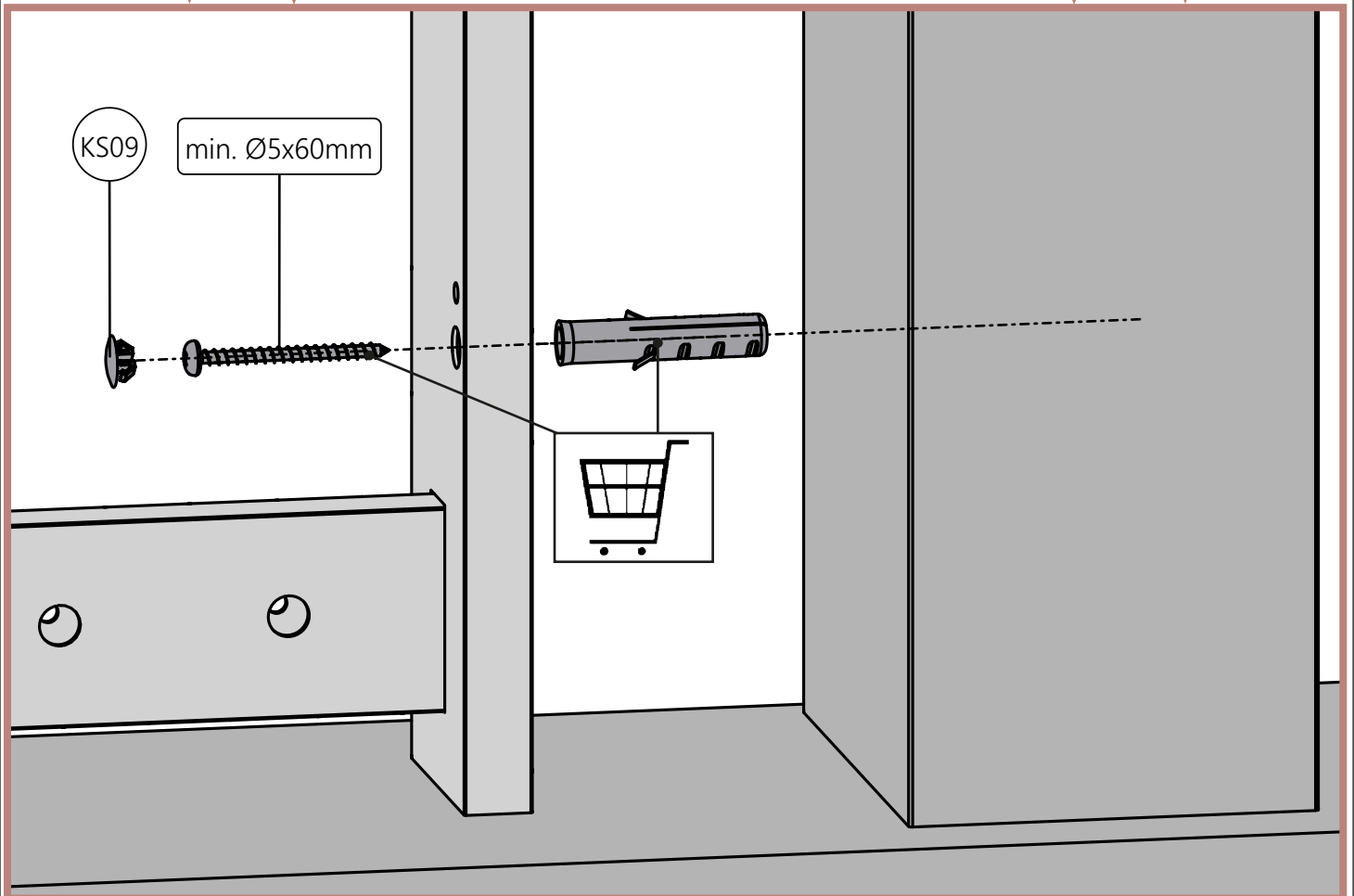
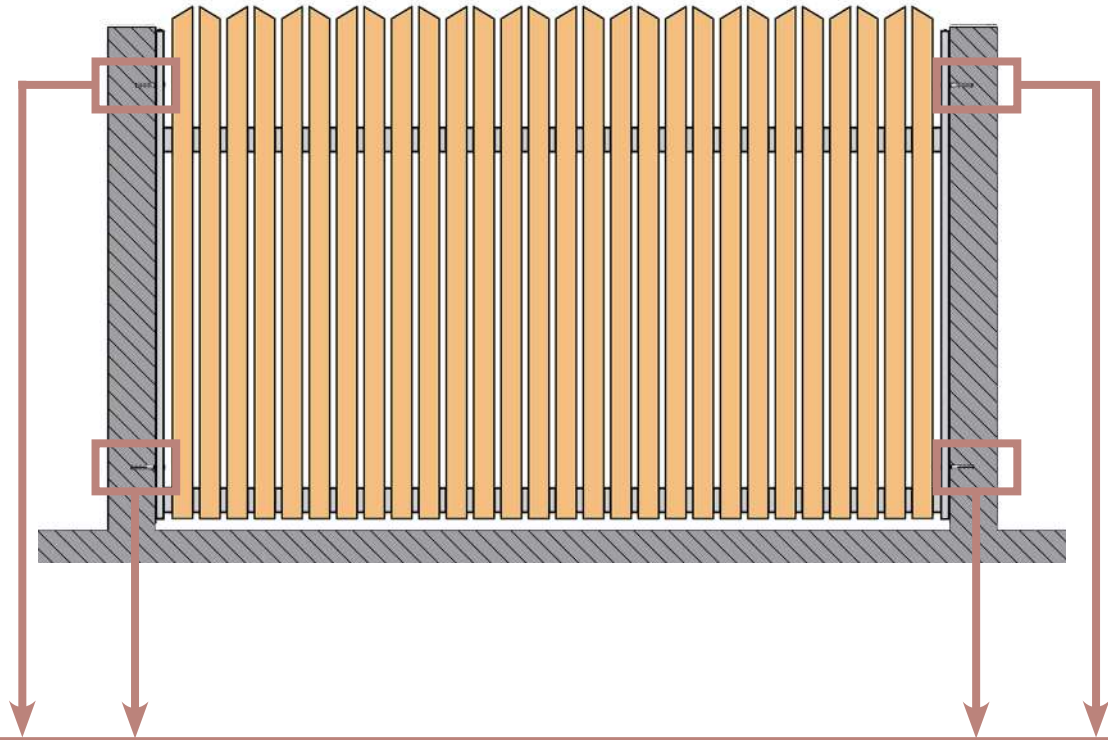

12

A

B

C

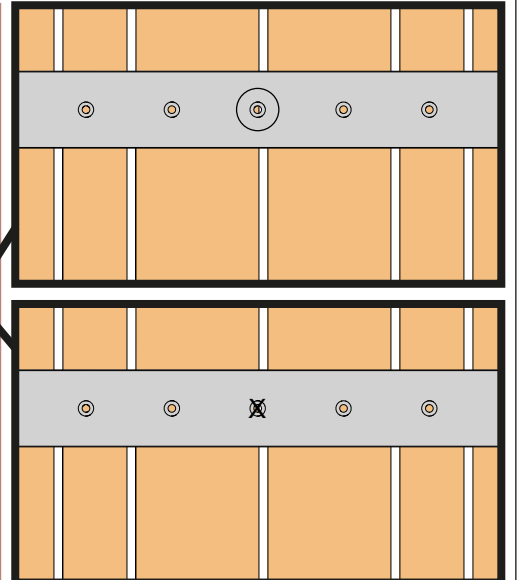
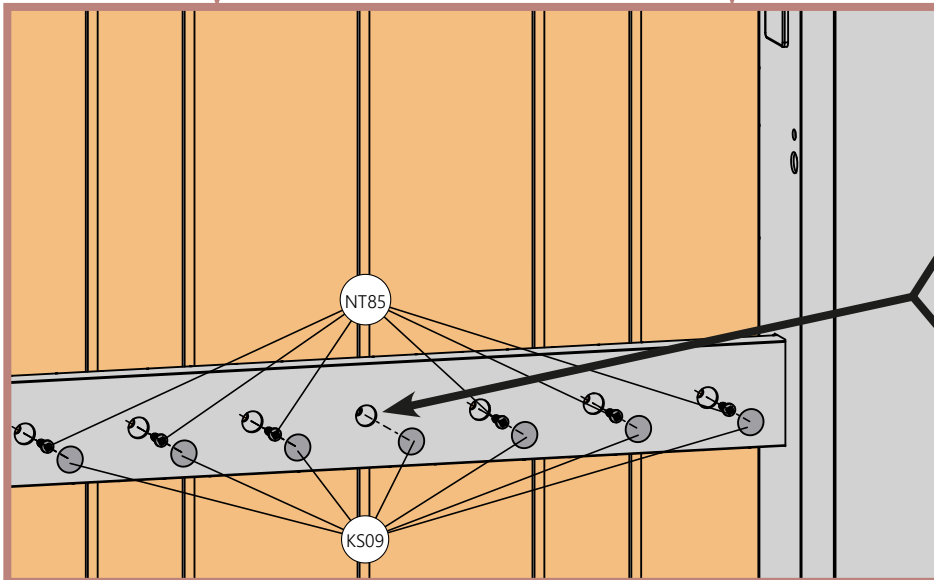
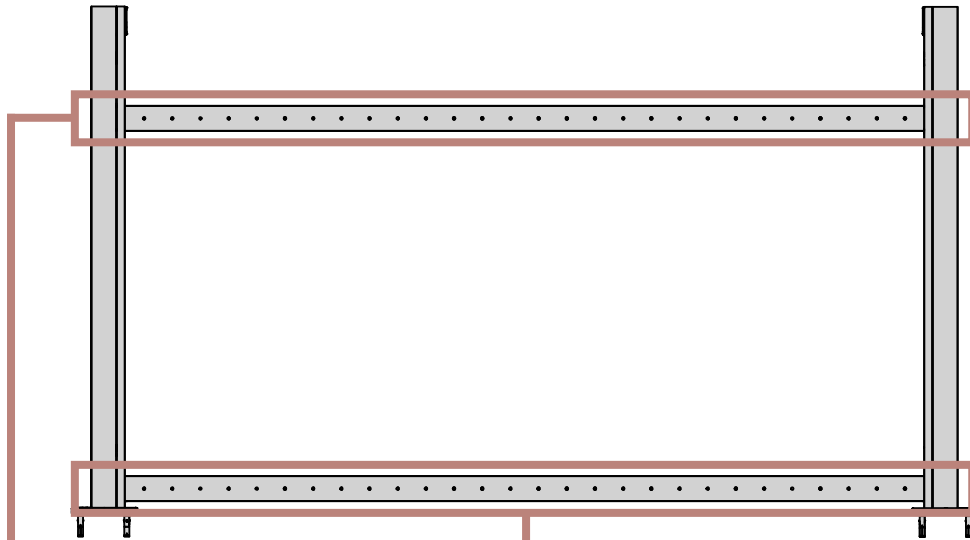
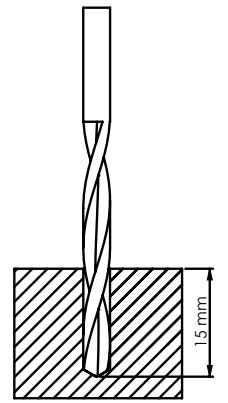
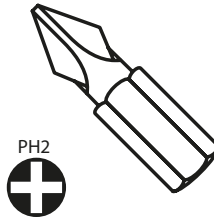
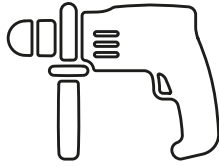
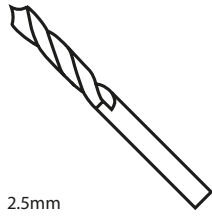

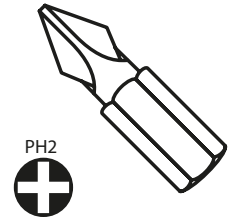
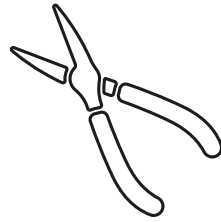

PH2



A

B

