

A

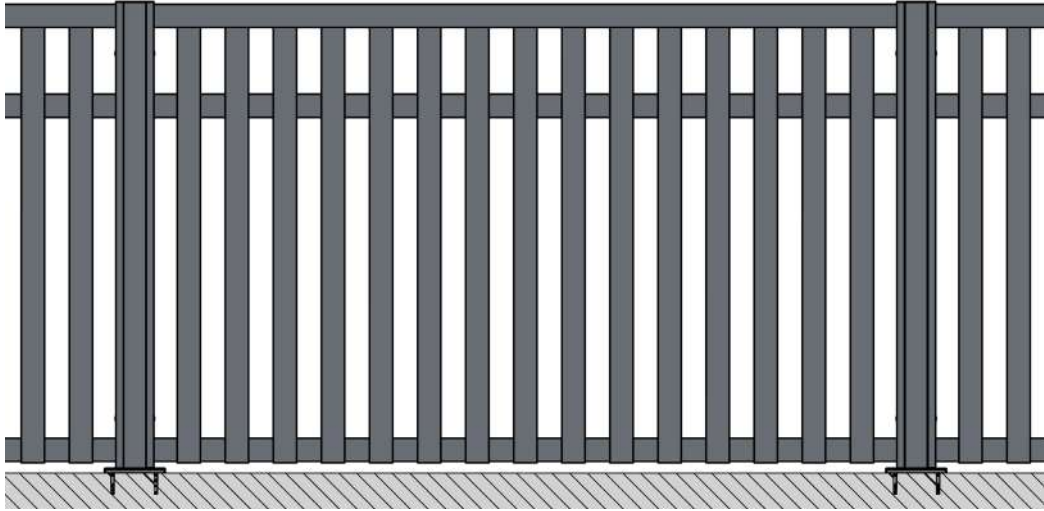

B

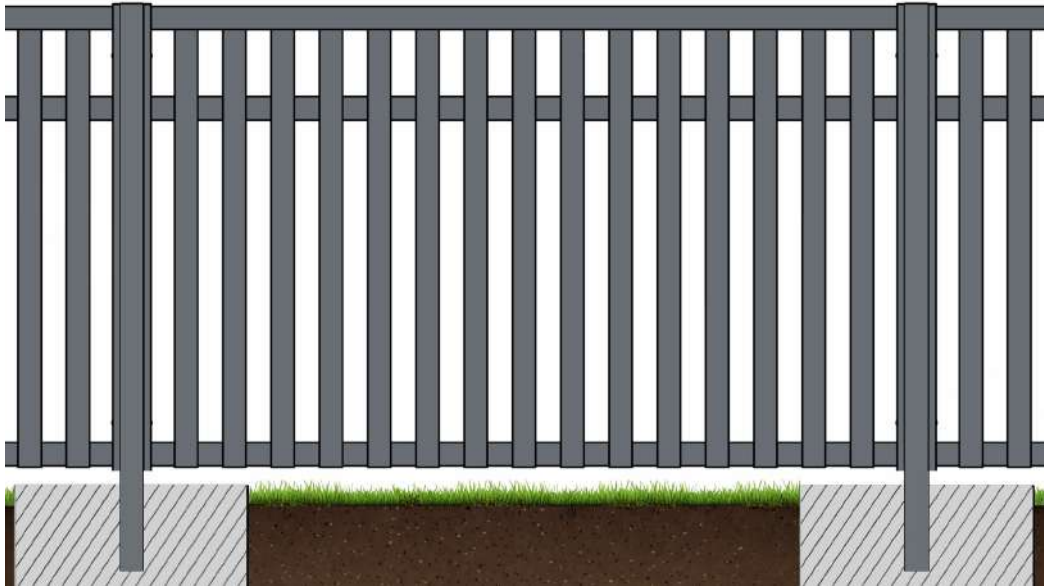

C

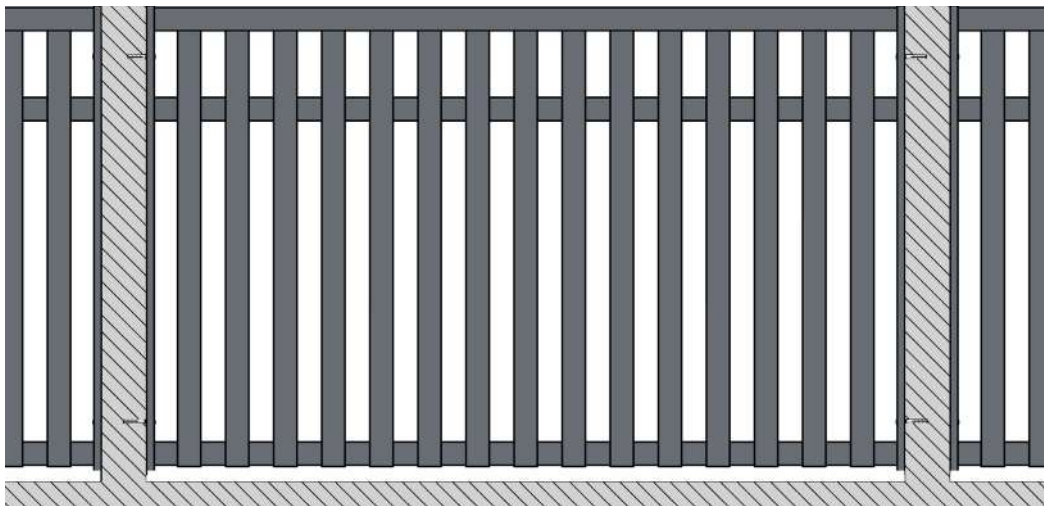

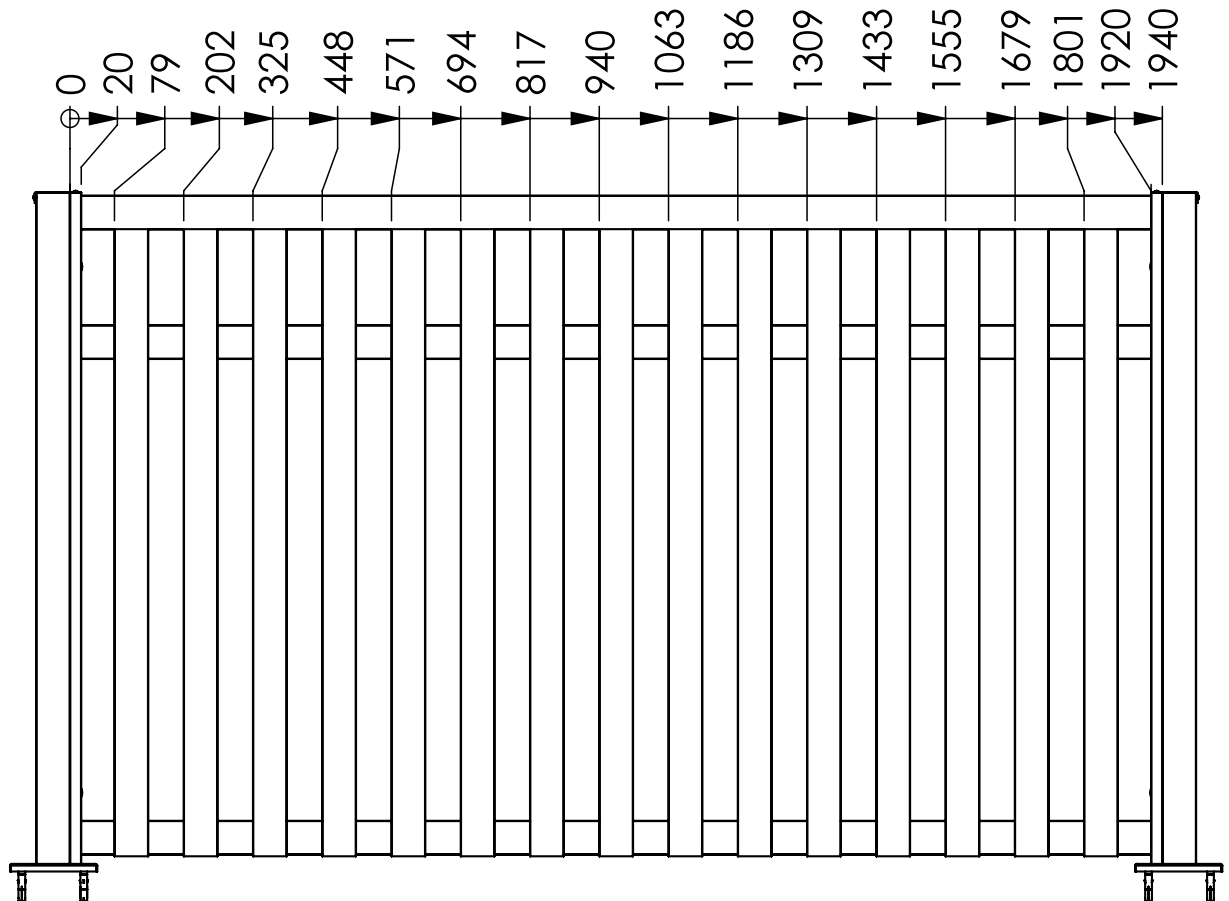
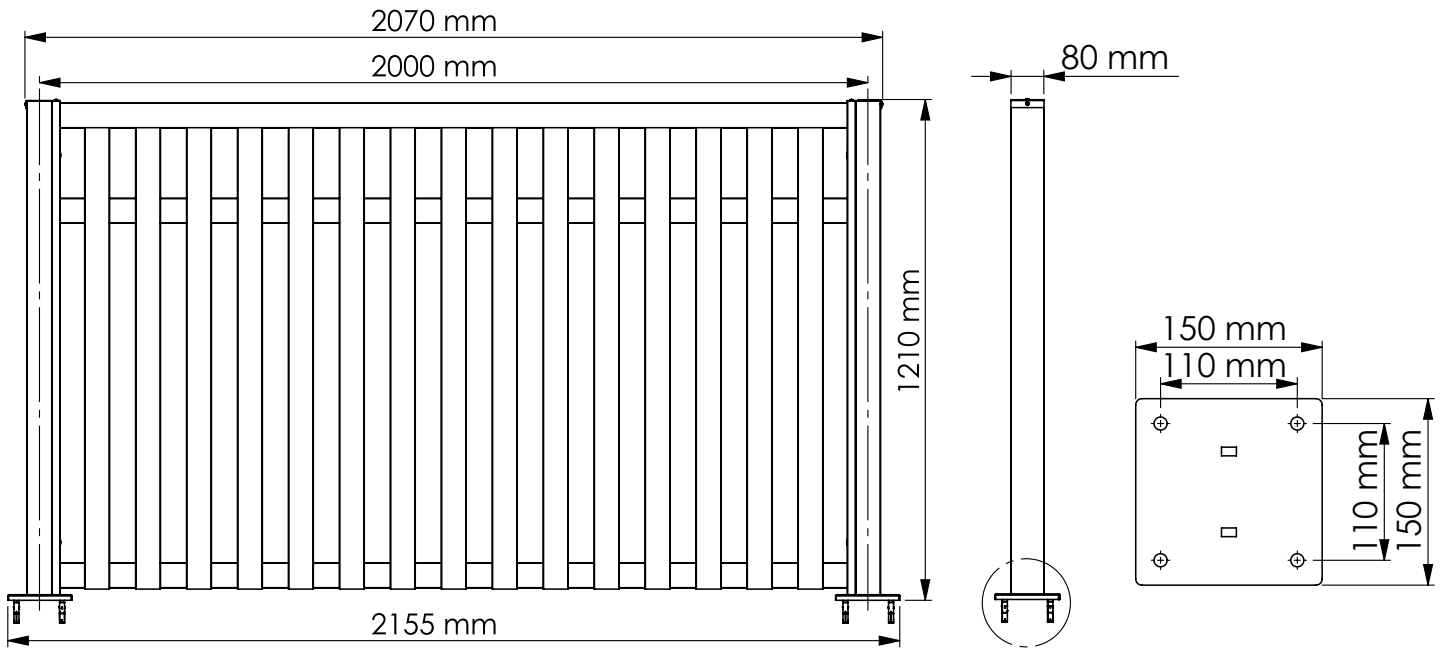

8x

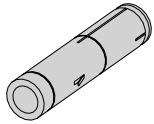

D01

M8x55 mm

4x

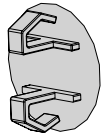

KS09

Ø13 mm

8x

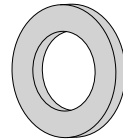

NT26

M8 DIN125A

12x

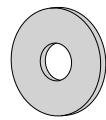

NT39

M5 DIN9021

8x

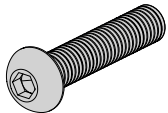

NT47

M8x60 mm
ISO7380-1

6x

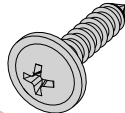

NT77

Ø3,5x16mm

30x

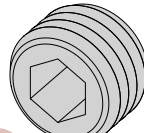

NT78

M6x6mm

4x

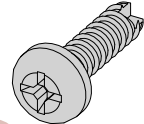

NT79

Ø5,5x22 mm

2x

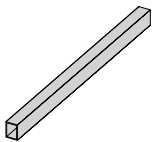

ZT01

80x60x1200 mm

2x

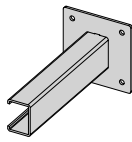

ZT02

2x

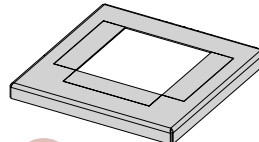

ZT03

2x

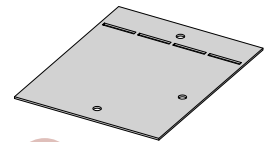

ZT04

2x

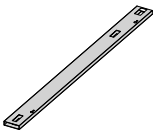

ZT06

80x20x1200 mm

1x



ZT07

60x30x1940 mm

2x



ZT08

60x20x1940 mm

15x

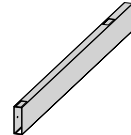

ZT13

60x30x1113,5 mm

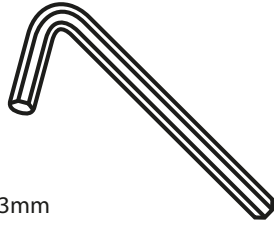
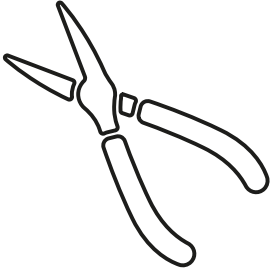

3mm
5mm

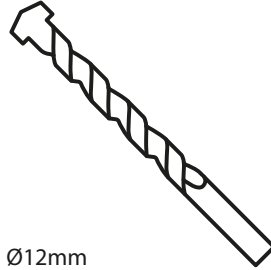

Ø12mm

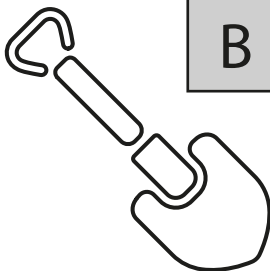
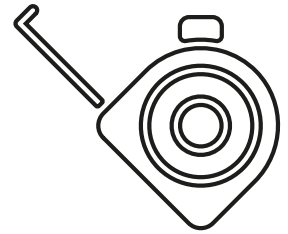
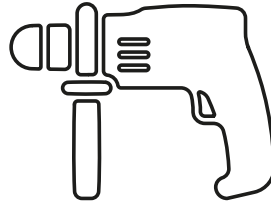
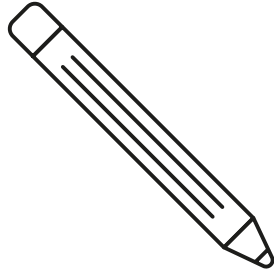
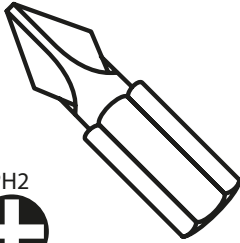
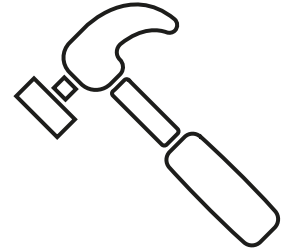

B

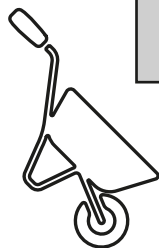

B

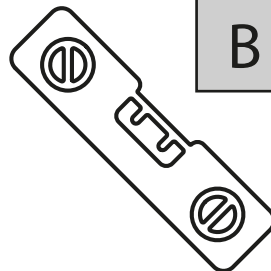

B

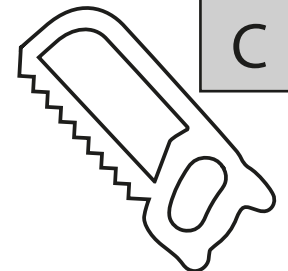

C

4x

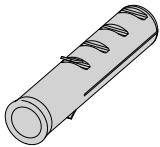

C

4x



C

min. Ø5x60 mm

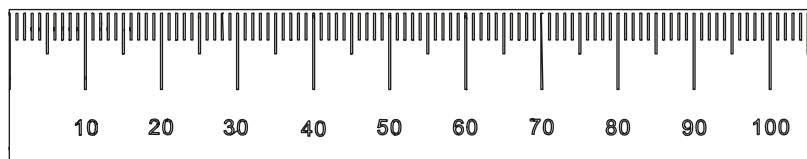

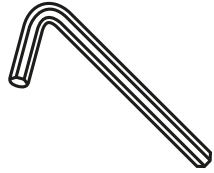
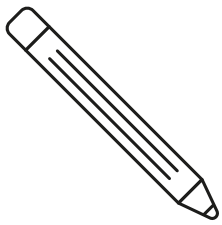

5mm

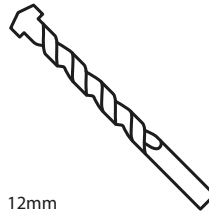
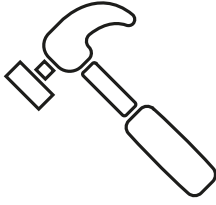

12mm

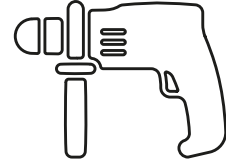

1

A

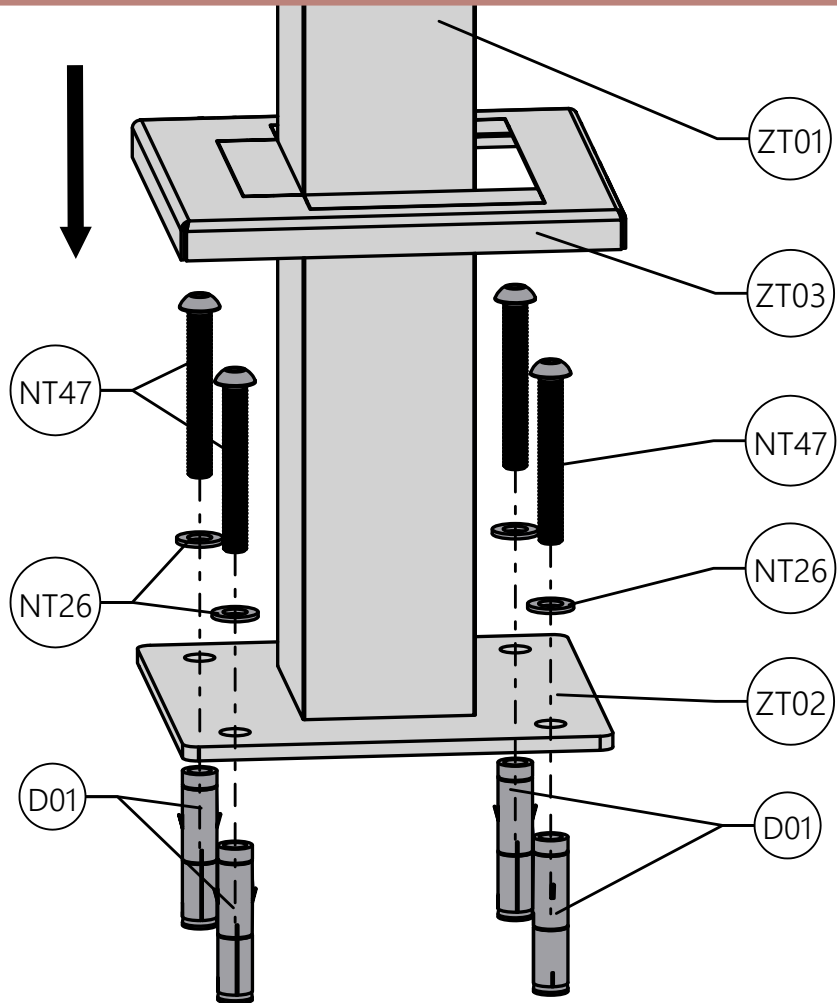
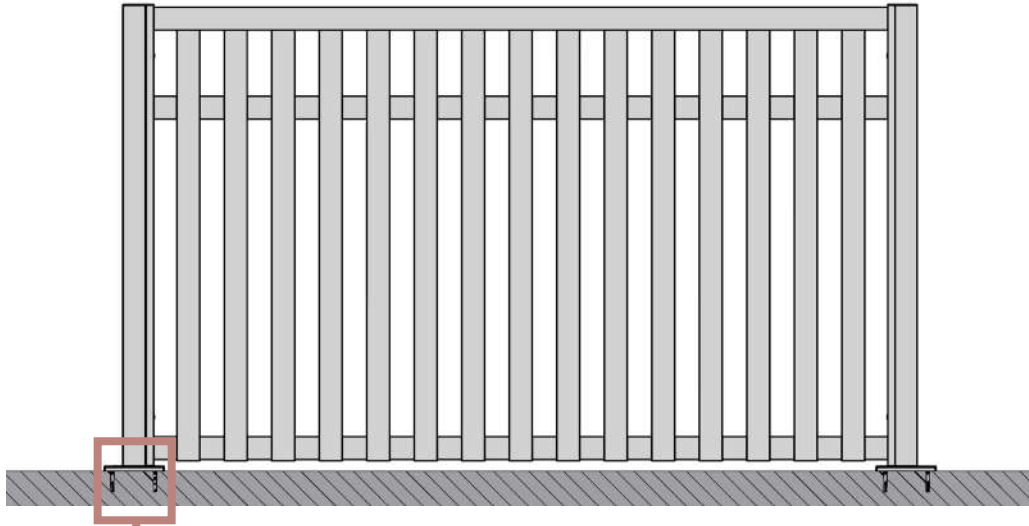

2

B

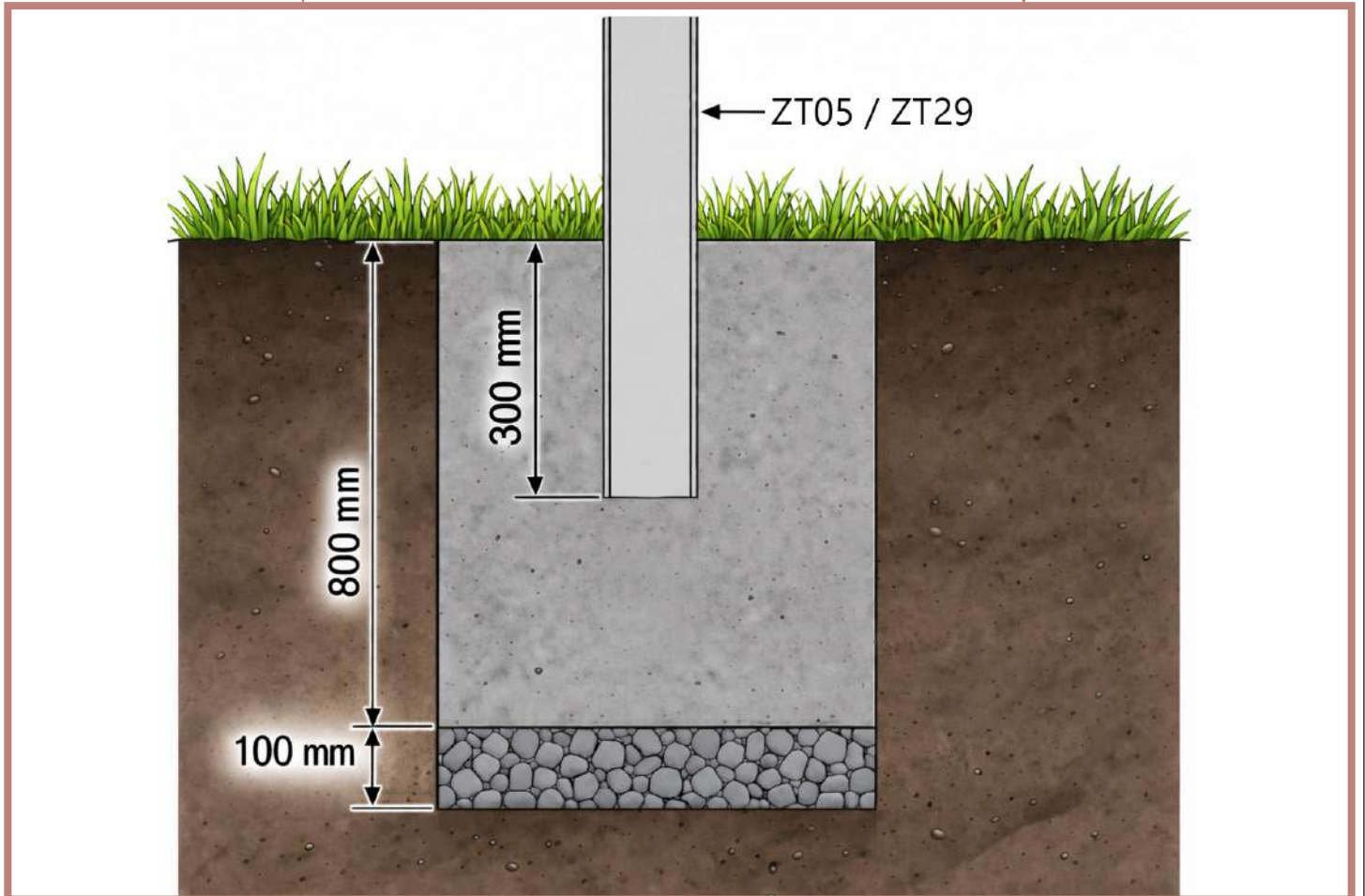
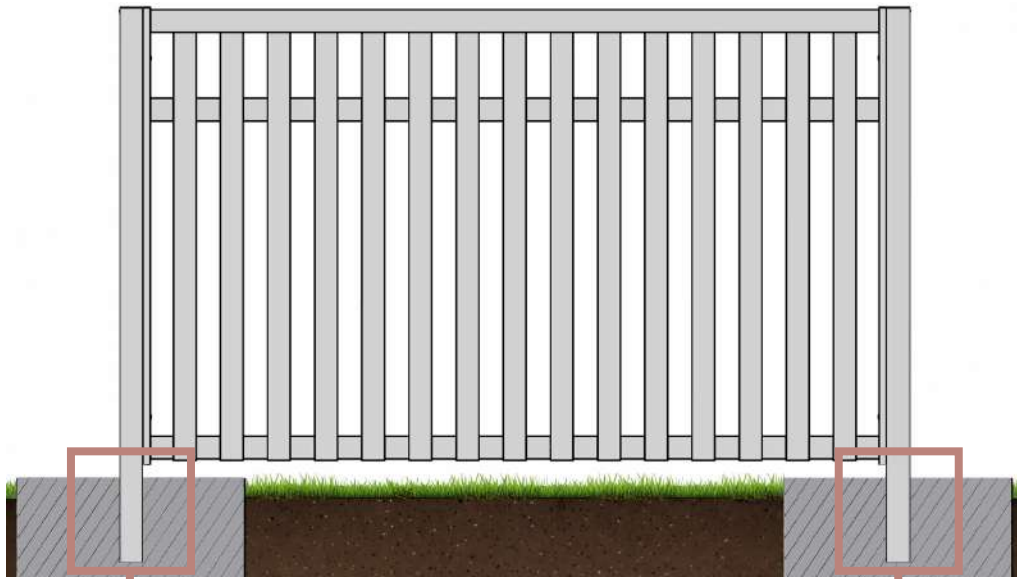
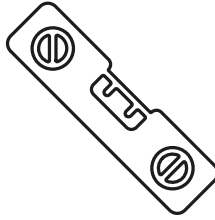
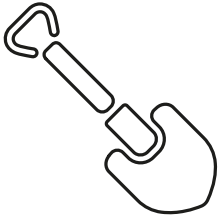

3

C

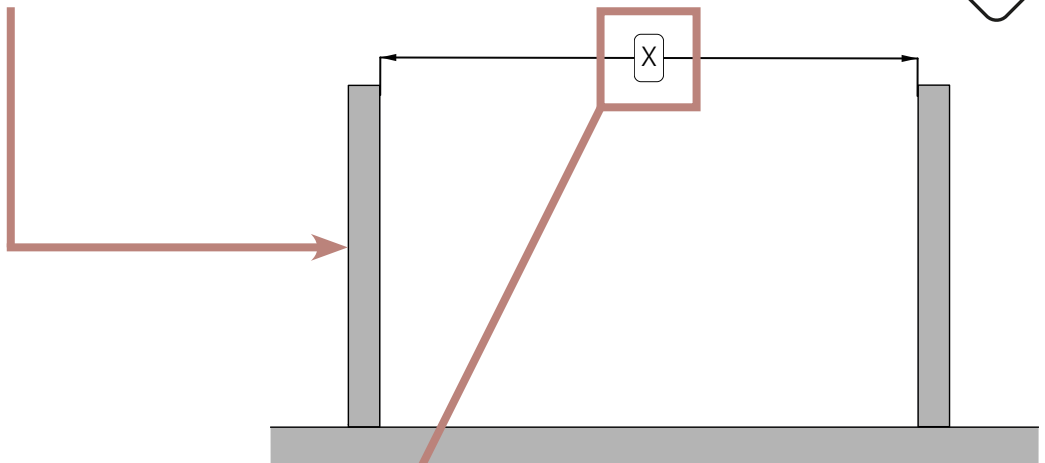
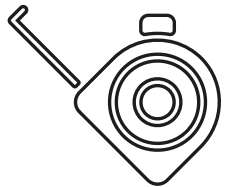
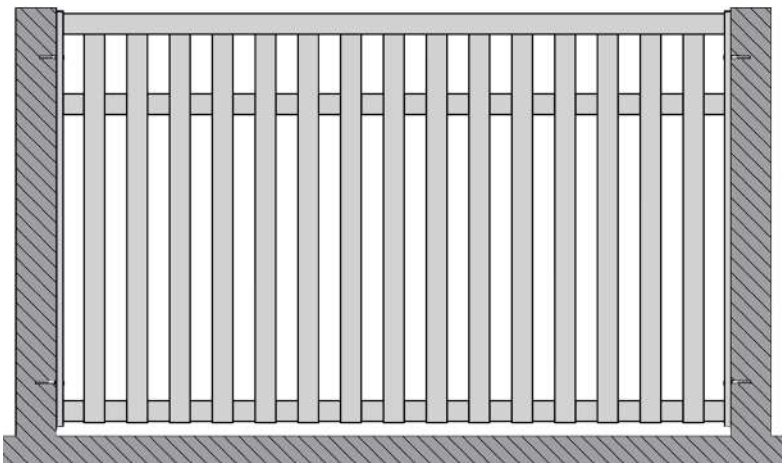

ZT07

ZT08

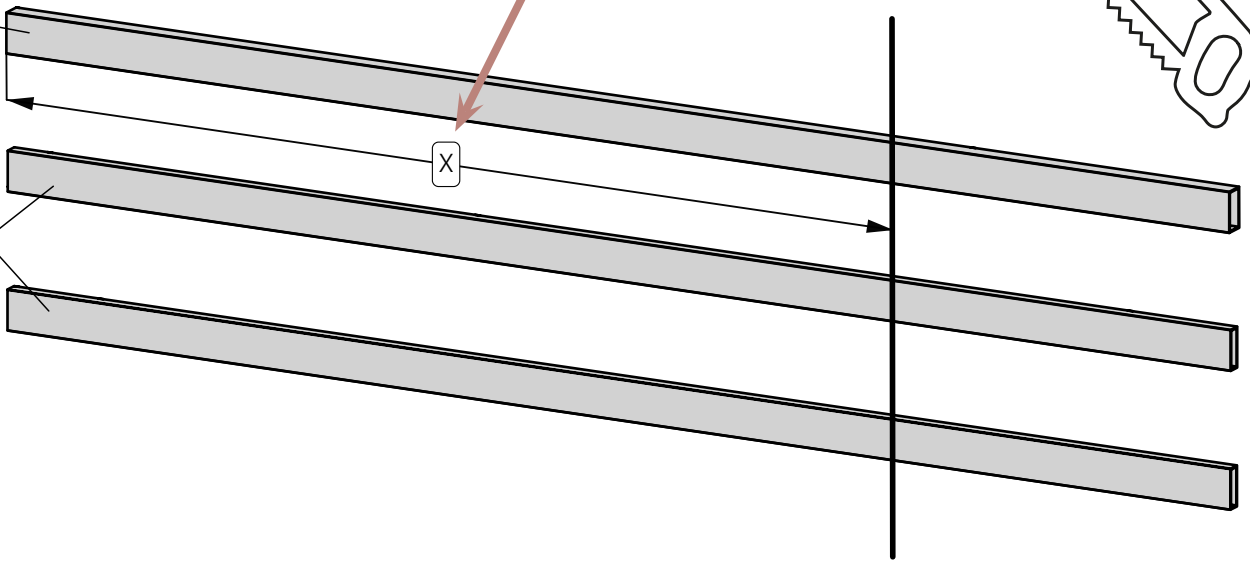

4

A

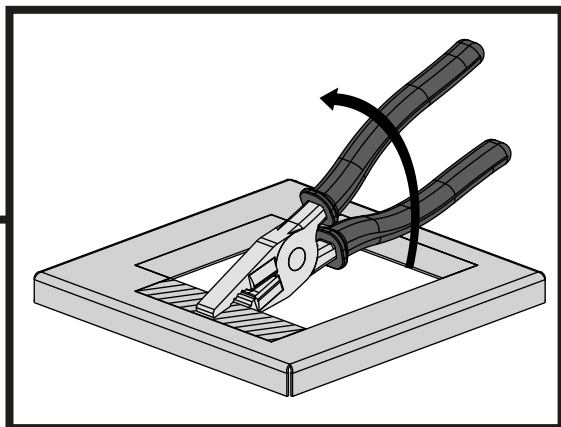
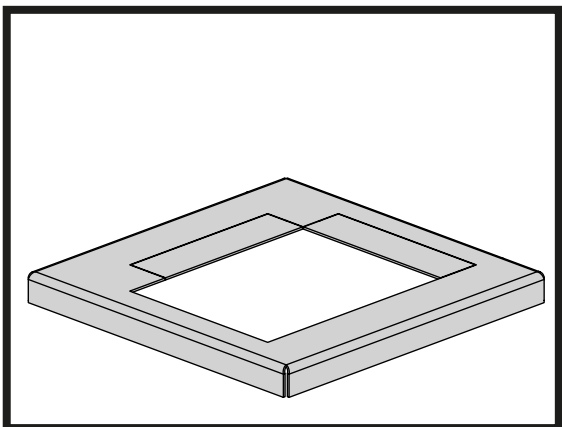
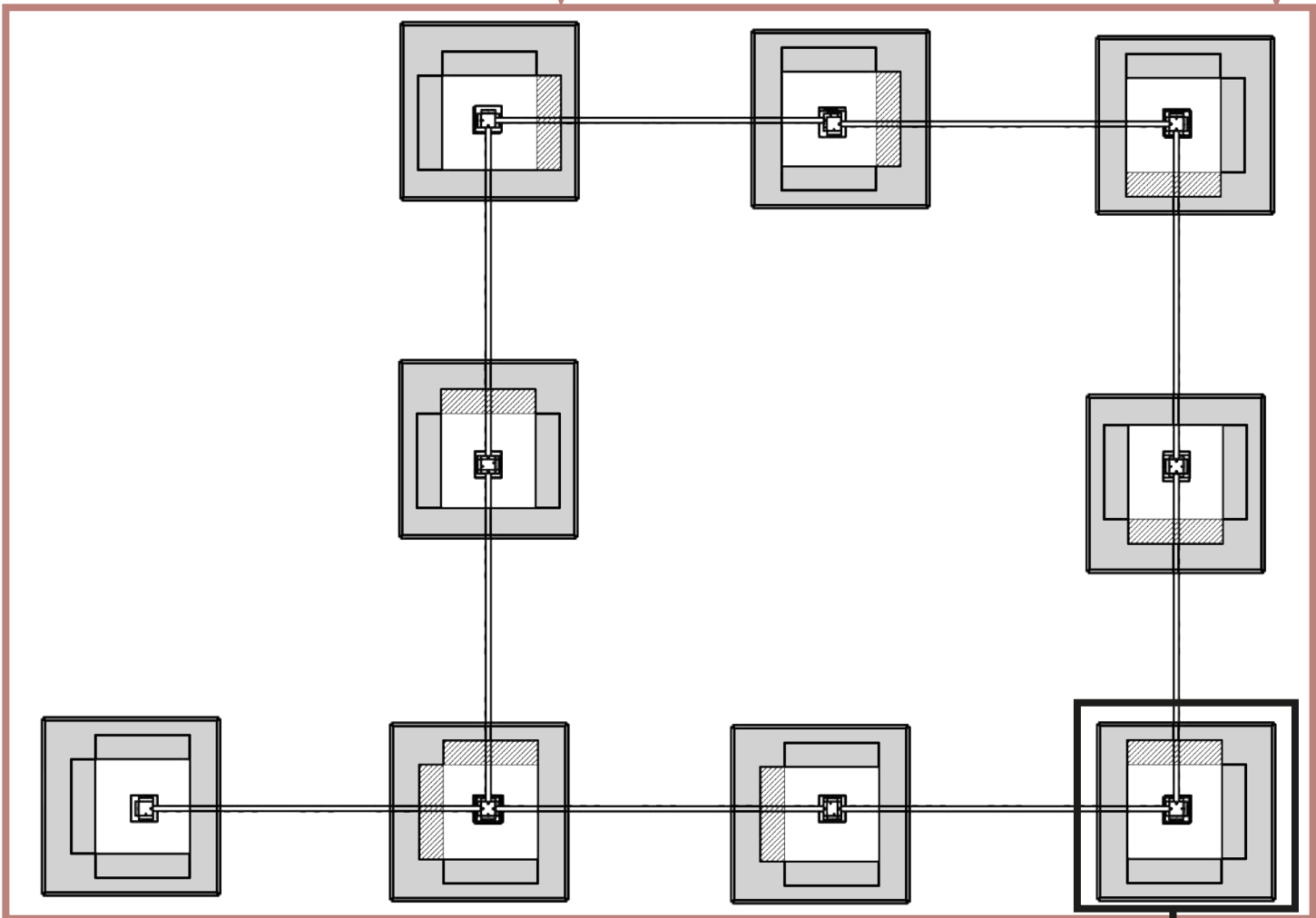
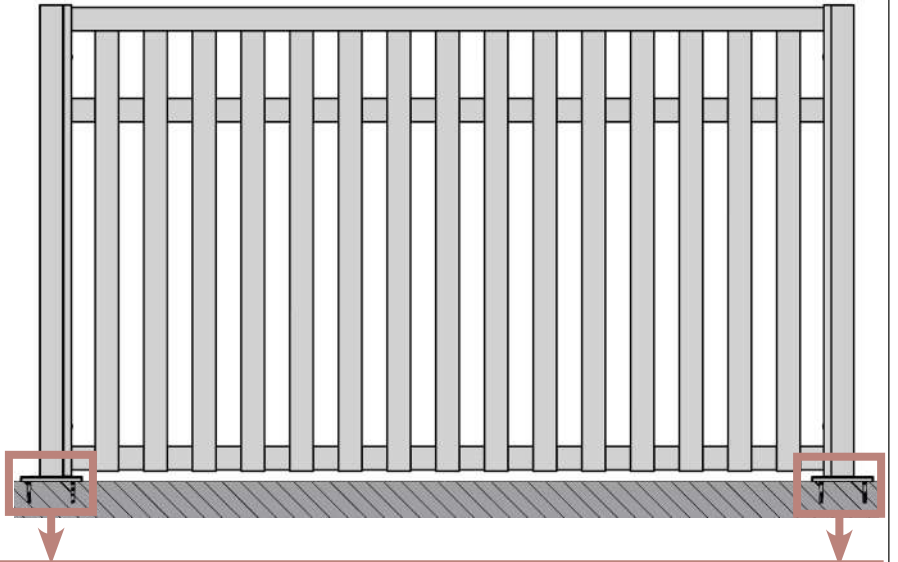
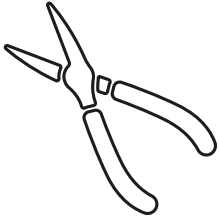

5

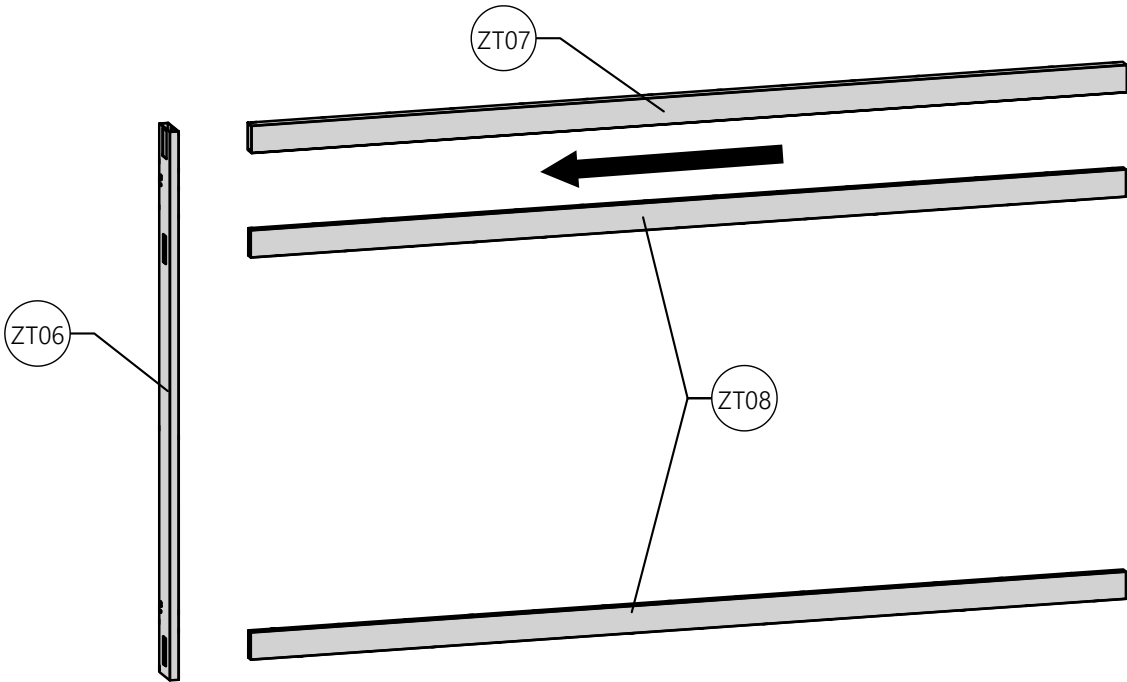

A

B

C

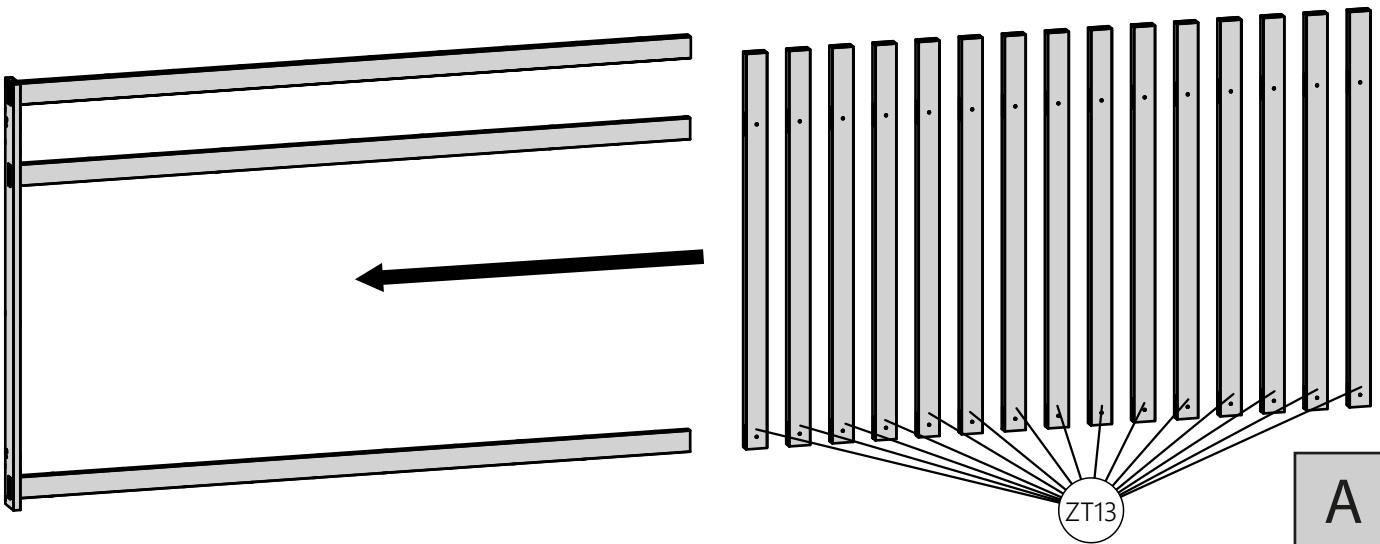

A

B

C

7

A

B

C

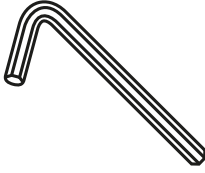

3mm

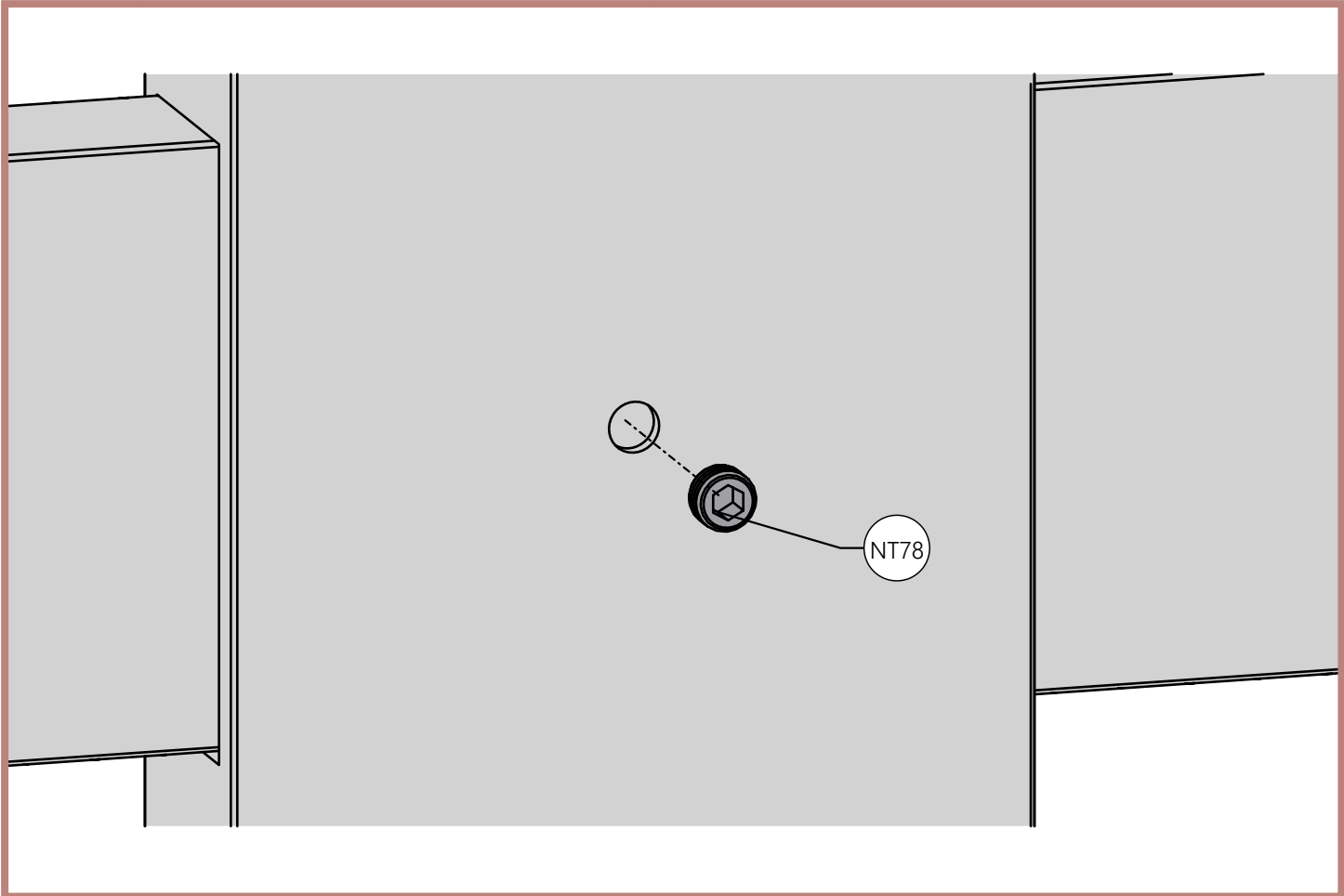
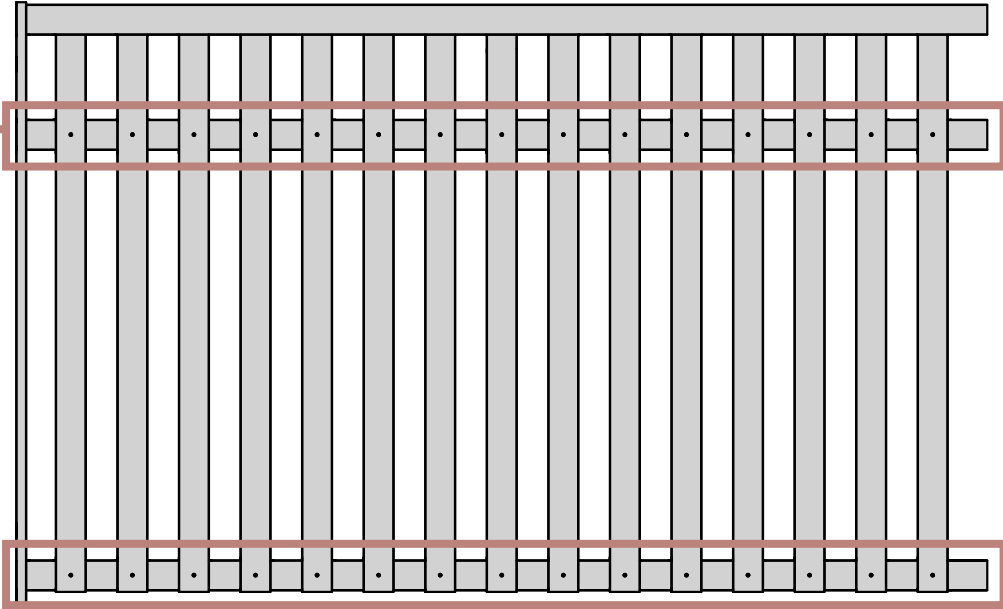

8

A

B

C

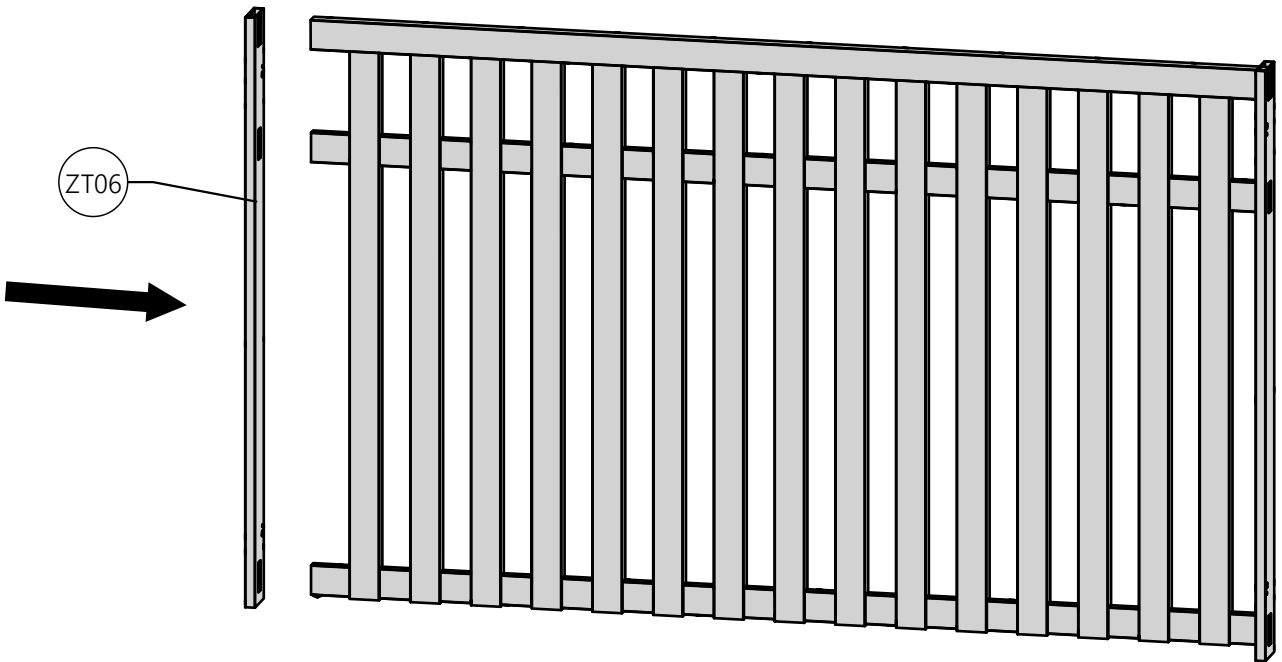
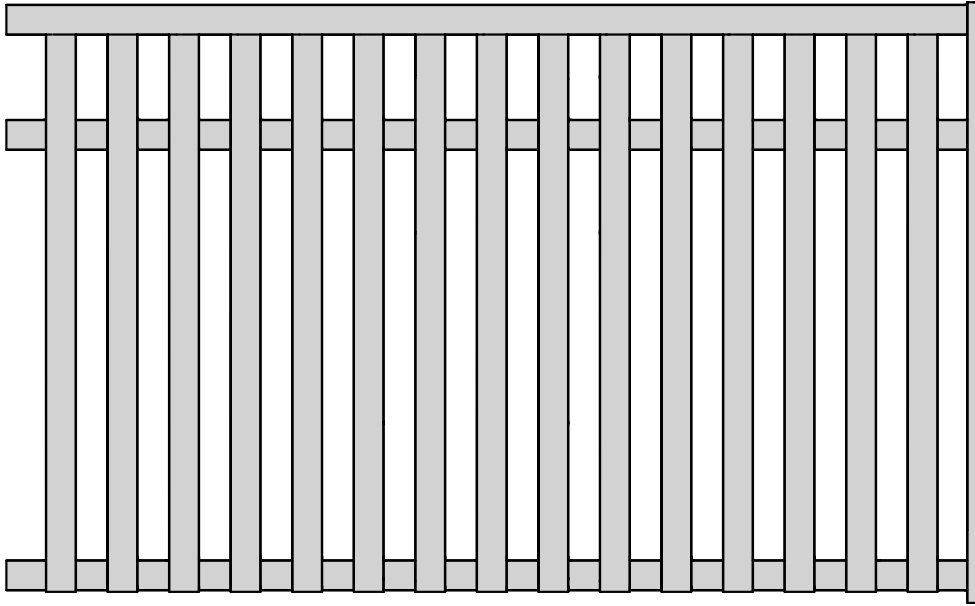

9

A

B

C

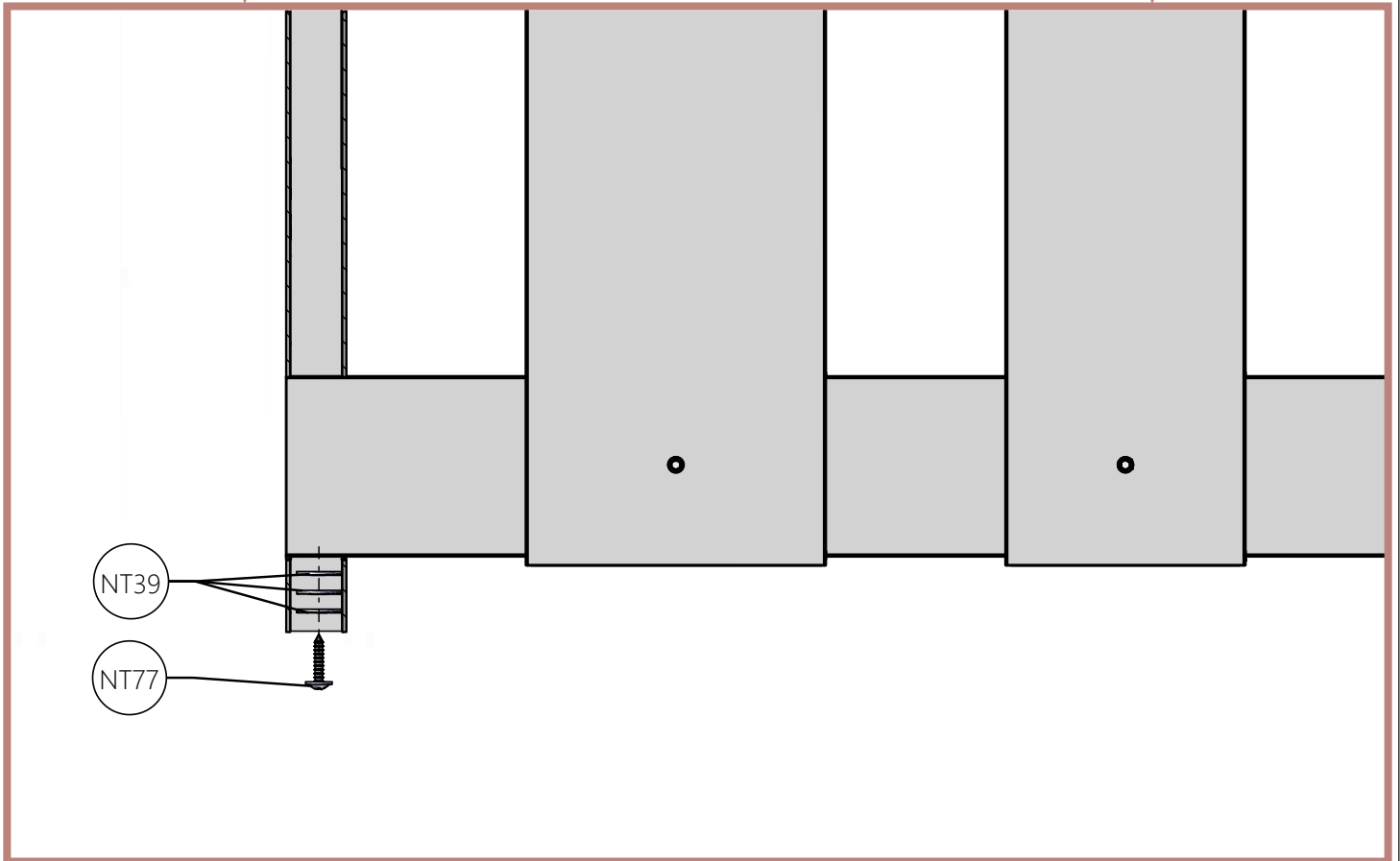
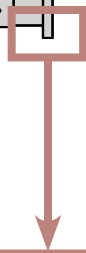
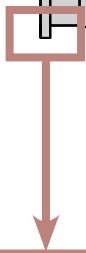
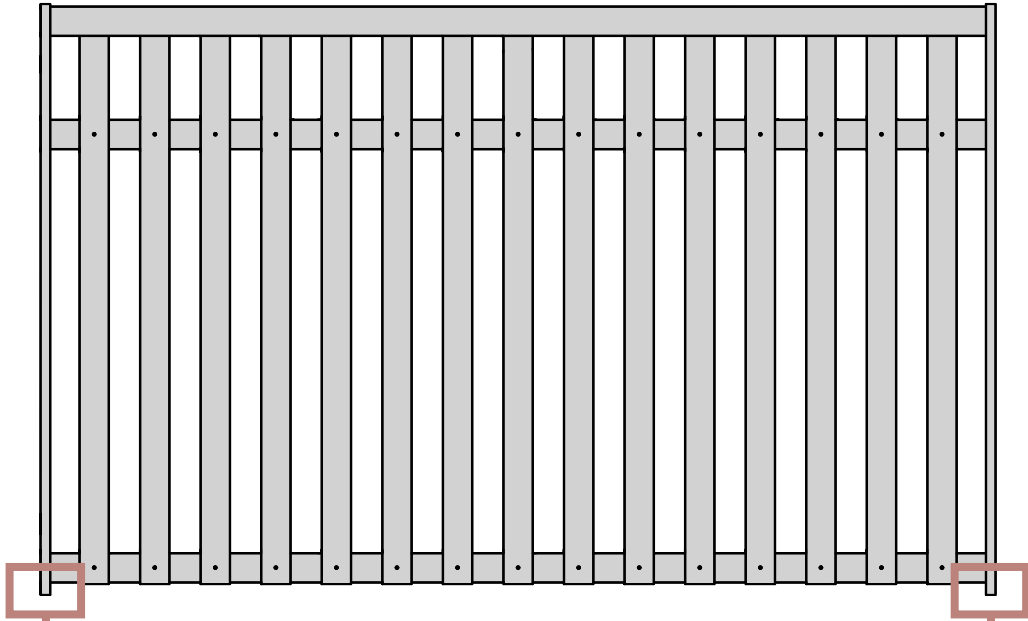
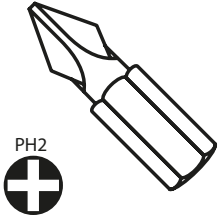

10

A

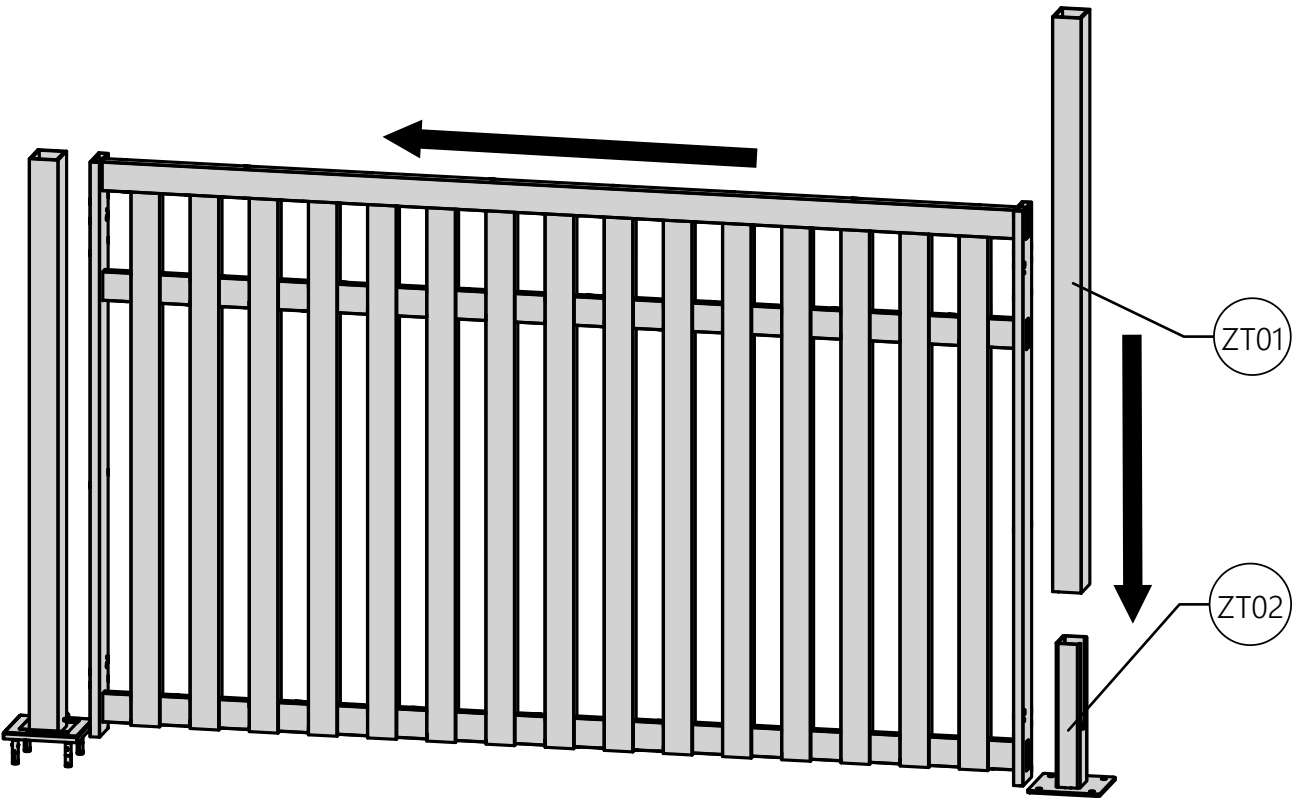
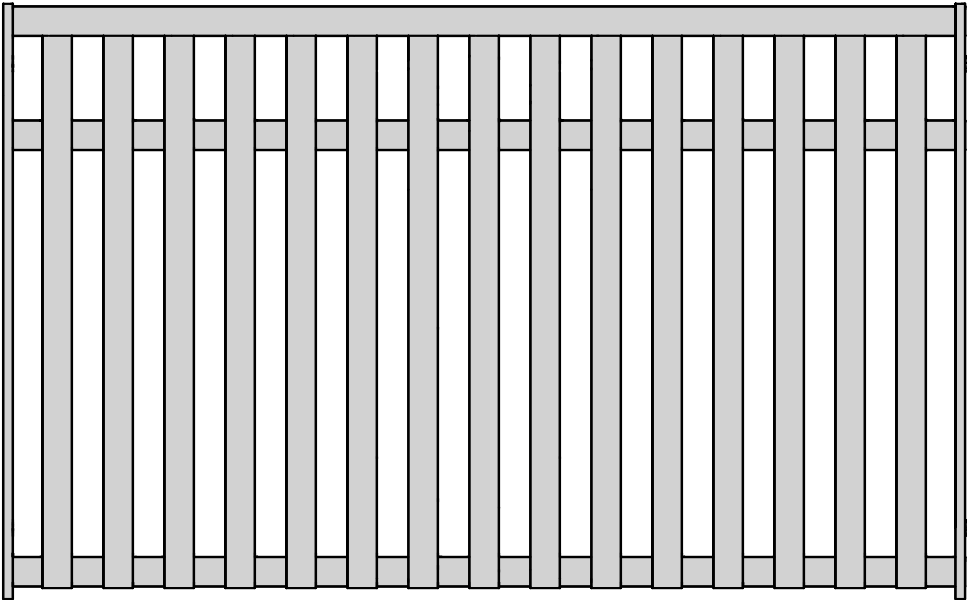

11

A

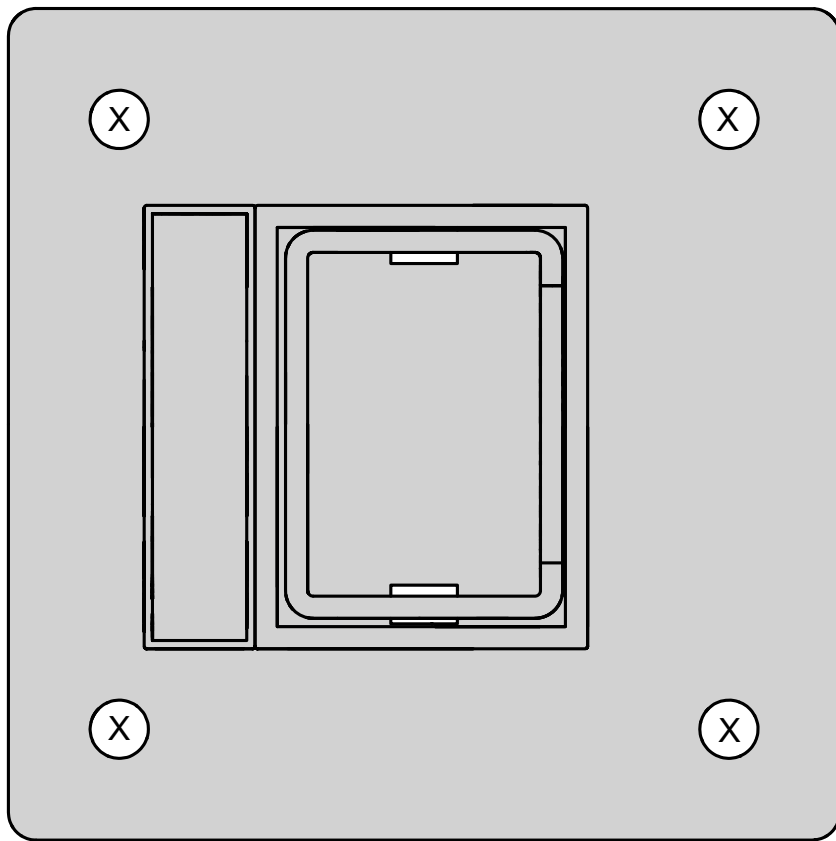
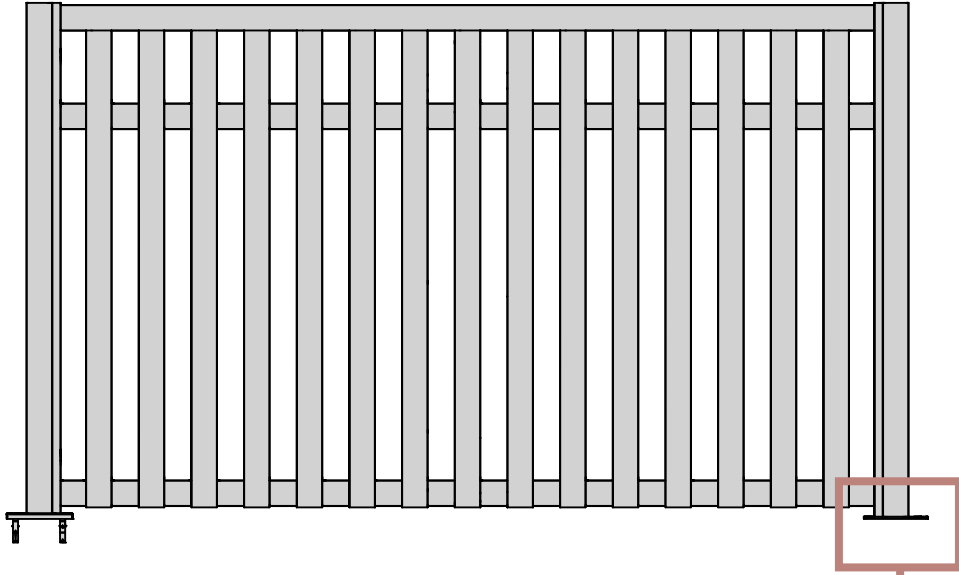
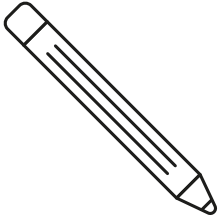

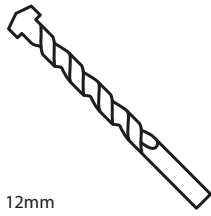
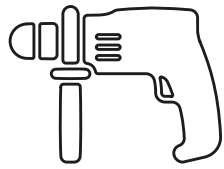

12mm

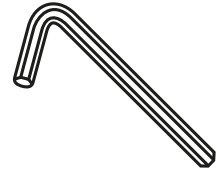
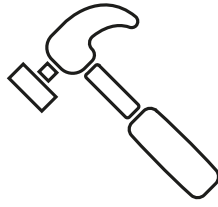

5mm

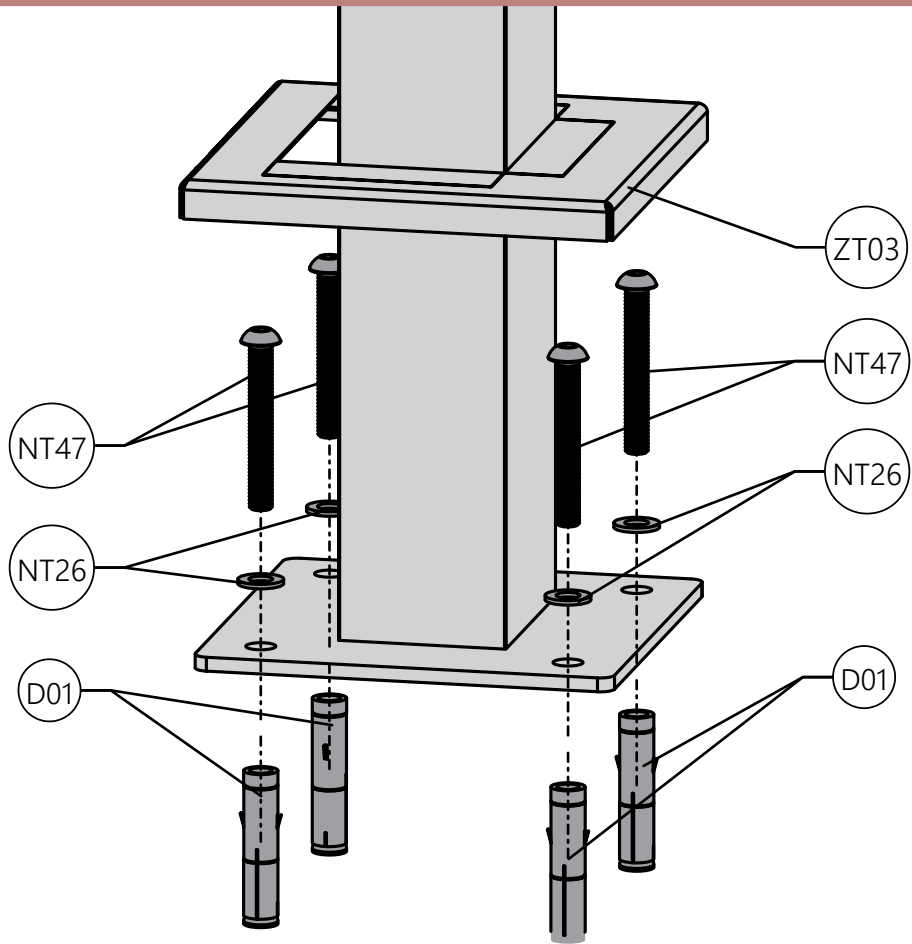
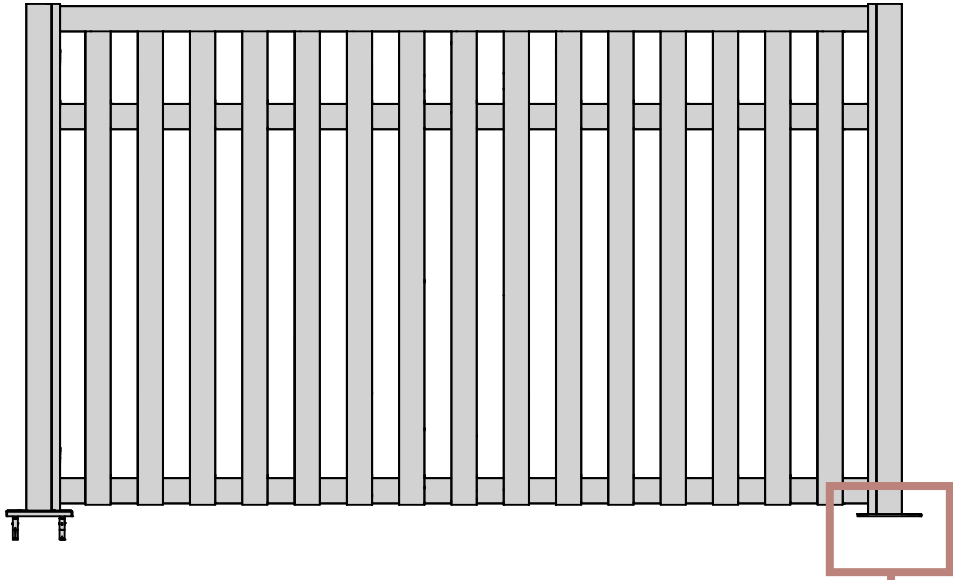

13

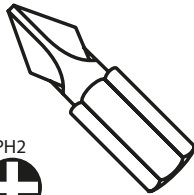

A

B

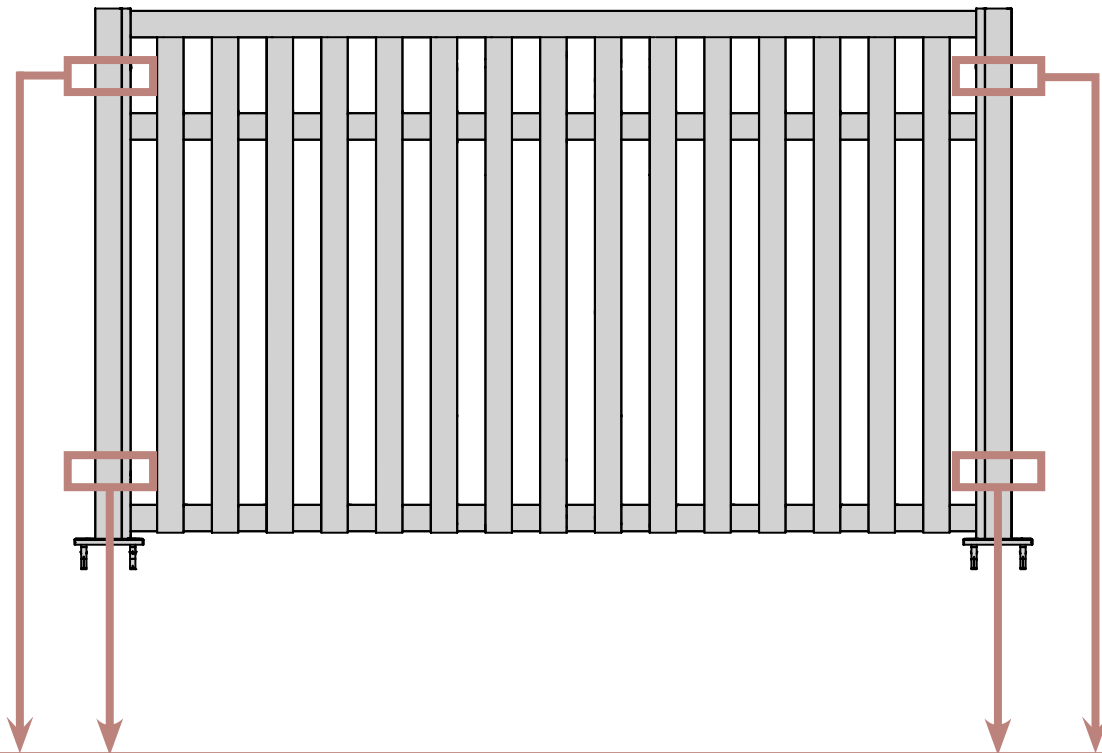

KS09

NT79

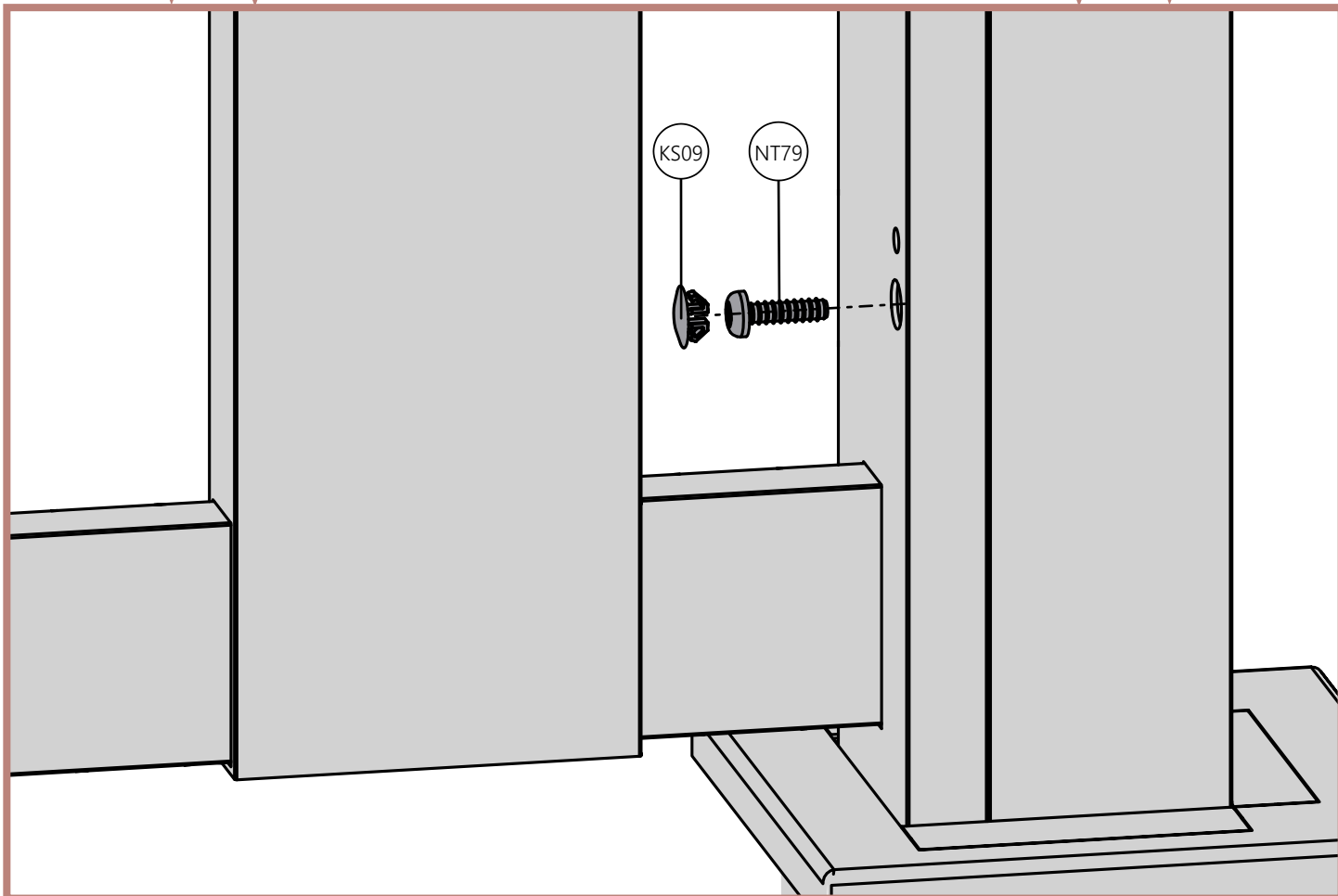
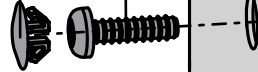

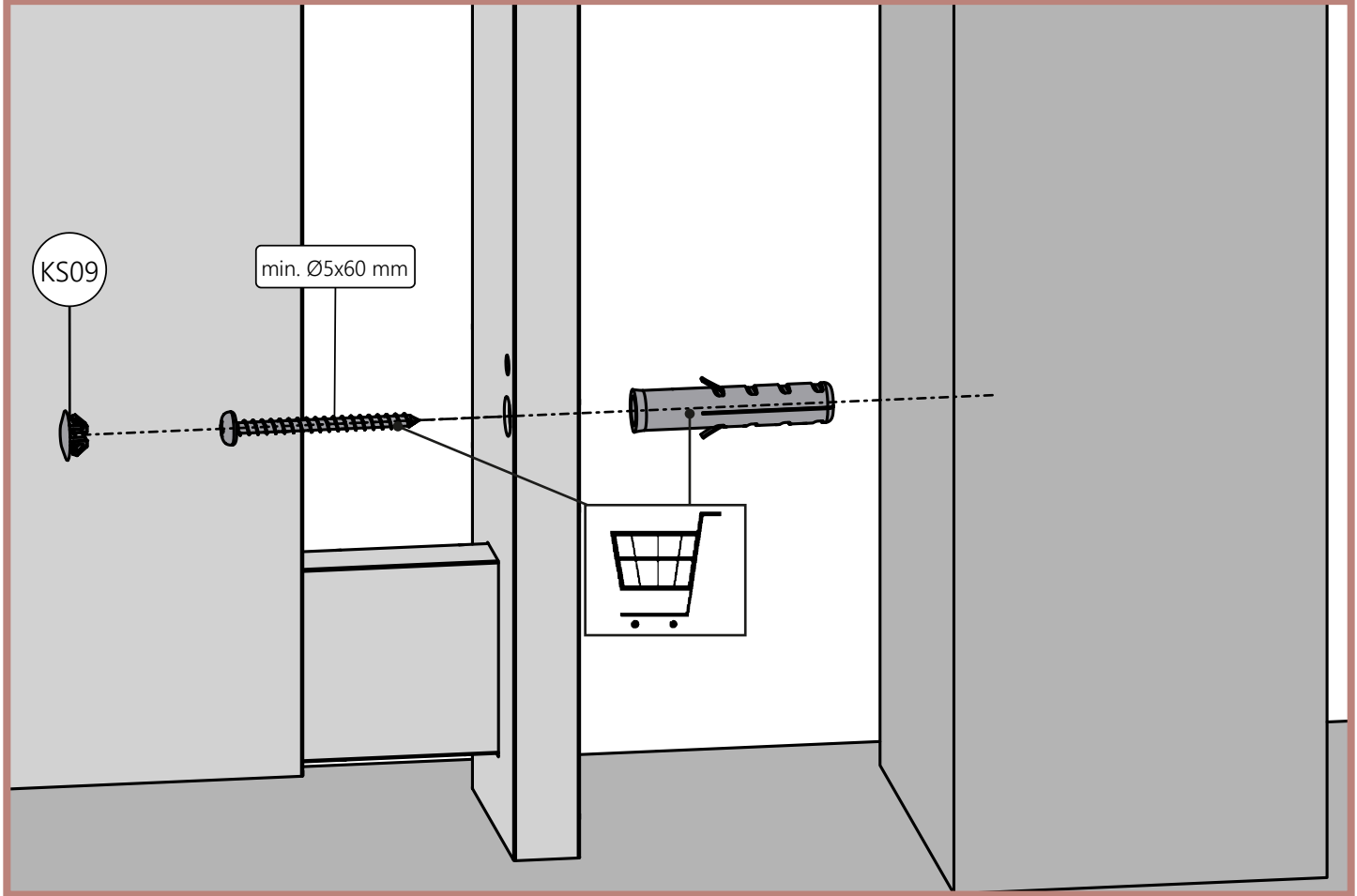
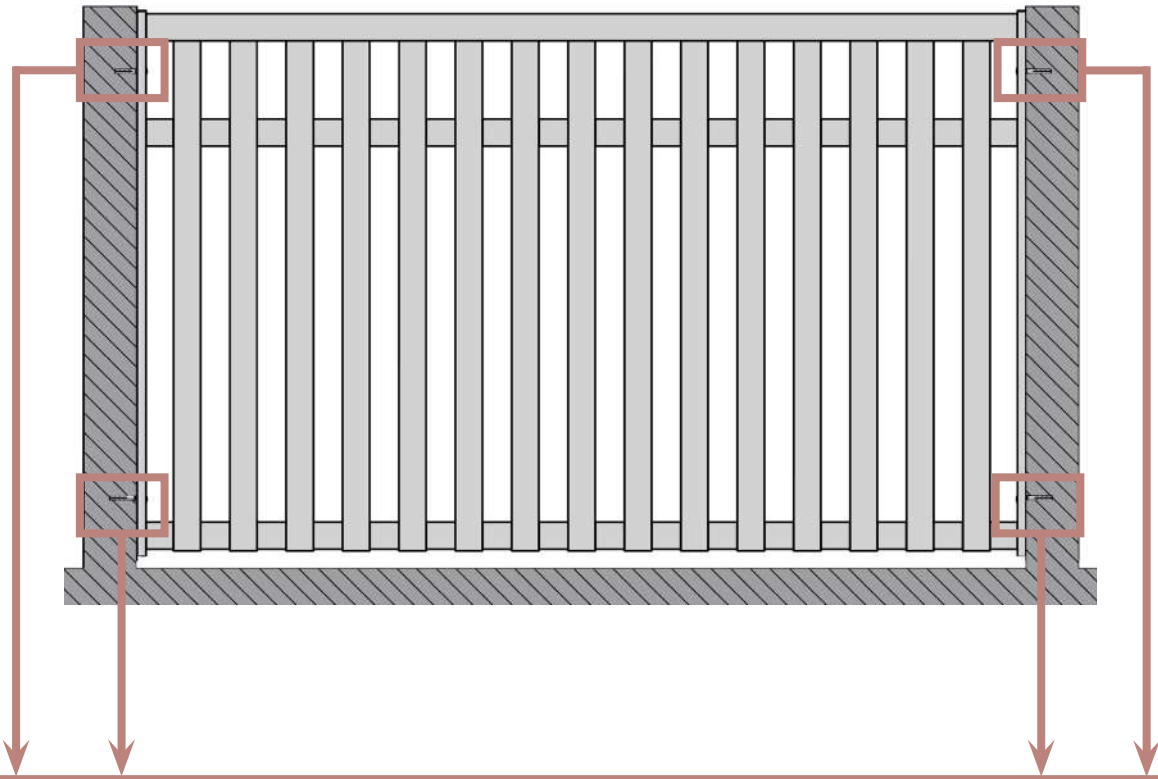
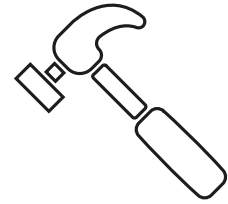
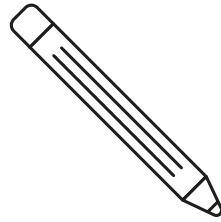
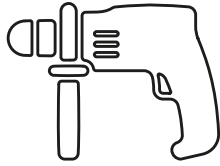
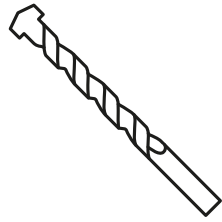

15

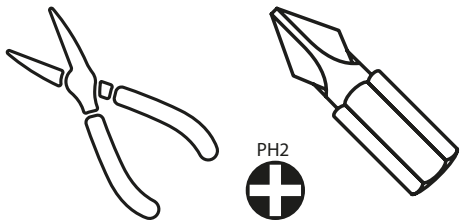

A

B

