

Alex

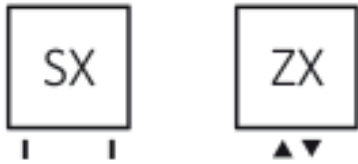

Anschlusstypen

Warmwasserbetrieb



Mischbetrieb

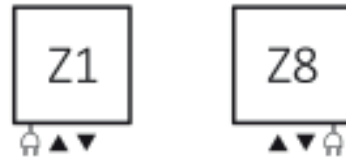

Verfügbare Größen

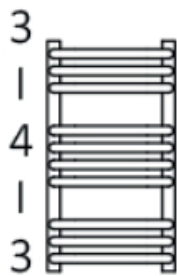

540 x 300
 ⇅ ⇄

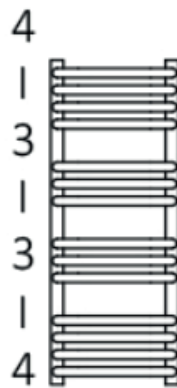

760 x 300







1140 x 300
 ⇅ ⇄

Technische Daten





Betriebsdruck: 1000 kPa

Maximale Betriebstemperatur: 95°C

A 	B 	C1	C2	75/55/20°C	55/45/20°C		D	E	F	H 	
[mm]	[mm]	[mm]	[mm]	[W]	[W]	[W]	[mm]	[mm]	[mm]	[dm ²]	[kg]
540	300	50	270	180	99	200	270	360	90	1.75	3.71
760	300	50	270	257	138	300	270	580	90	2.46	5.15
1140	300	50	270	362	194	400	270	960	90	3.78	7.84

Pulverlack

Galvanische Oberfläche

A 	B 	C1	C2	75/55/20°C	55/45/20°C		D	E	F	H 	
[mm]	[mm]	[mm]	[mm]	[W]	[W]	[W]	[mm]	[mm]	[mm]	[dm ²]	[kg]
540	300	50	270	126	64	100	270	360	90	1.75	3.57
760	300	50	270	180	92	200	270	580	90	2.46	4.95
1140	300	50	270	253	129	300	270	960	90	3.78	7.56

Technische Zeichnung:

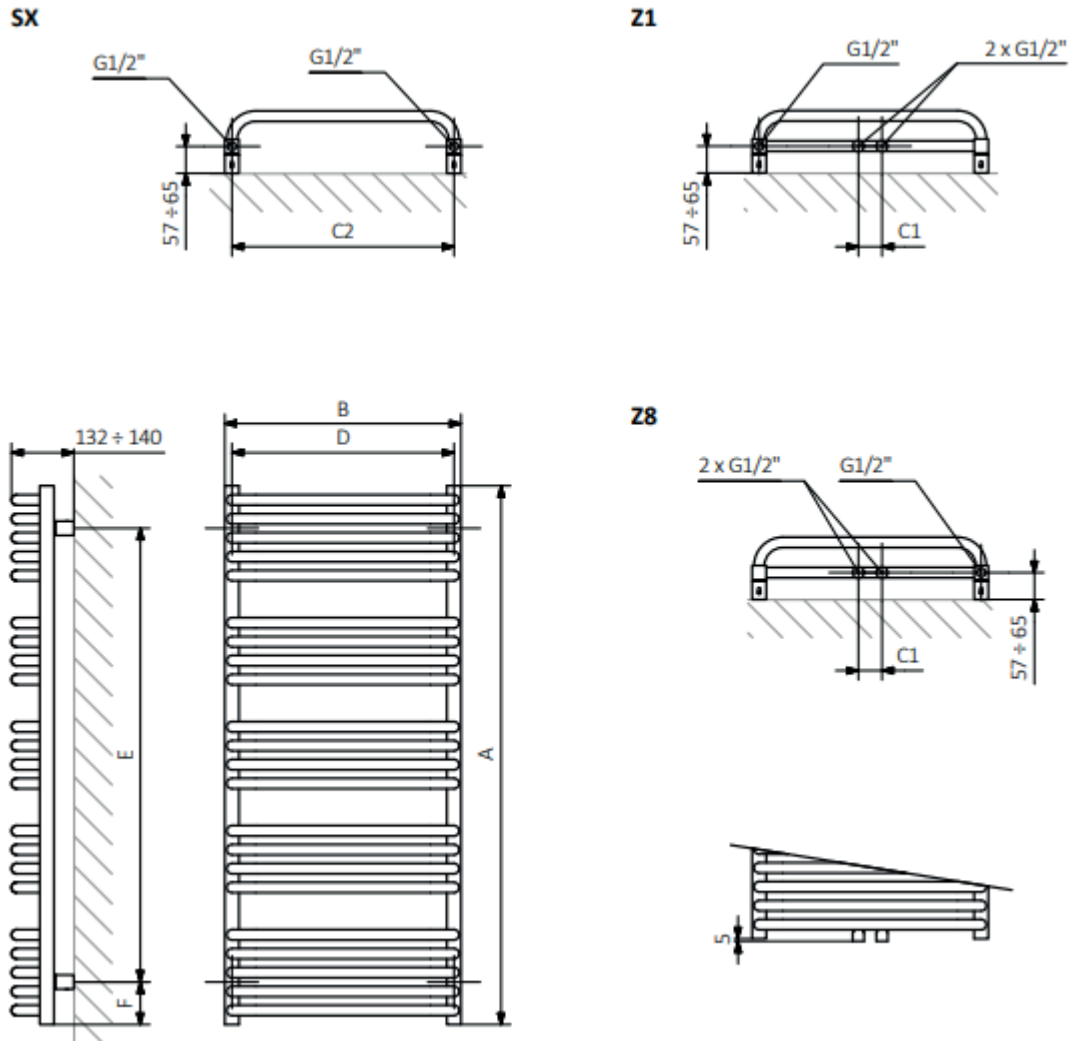

A – Höhe B – Breite C1-C5 – Anschlussabstand D – horizontaler Wandhalterungsabstand E – Vertikaler Wandhalterungsabstand F – Abstand von der Achse der unteren Wandhalterung bis Unterkante des Kollektors

Kollektor:

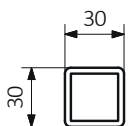

Rohr:

