

# Rolo Hanger - Warmwasserbetrieb



## Standard Anschlusstypen:

Warmwasserbetrieb



Mischbetrieb

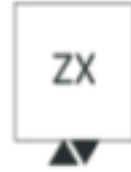

## Verfügbare Größen

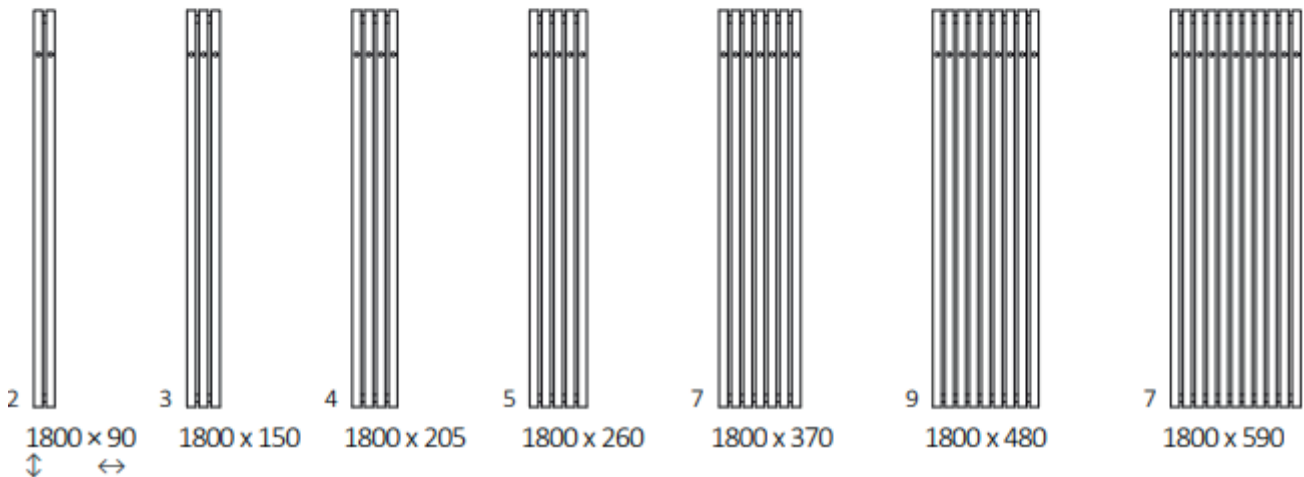
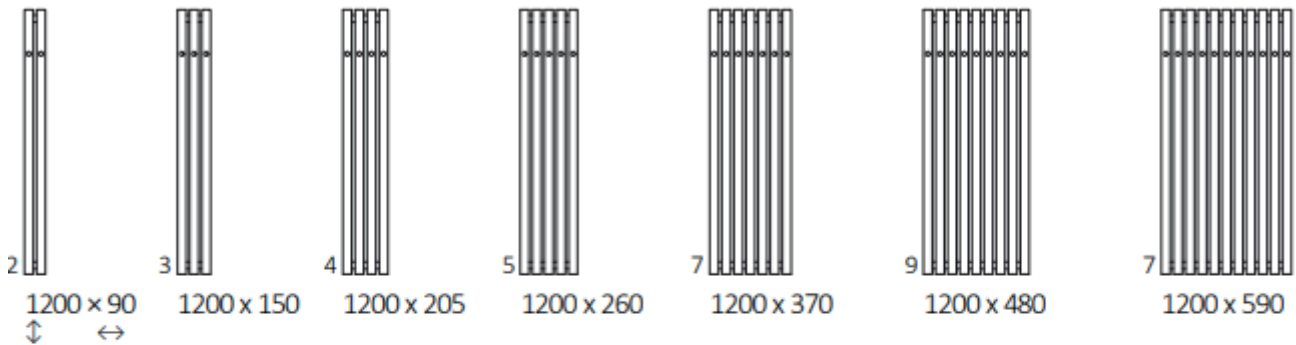



## ABMESSUNGEN UND TECHNISCHE INFORMATIONEN

Betriebsdruck: 1000 kPa

Maximale Betriebstemperatur: 95°C

Höhe A ↕ [mm]	Breite B ↔ [mm]	Heizleistung		
		75/65/20°C [W]	55/45/20°C [W]	 [W]
1200	95	162	82	200
1200	150	242	122	300
1200	205	323	163	300
1200	260	404	204	400
1200	370	565	285	600
1200	480	726	366	800
1200	590	888	447	800
1800	95	237	118	300
1800	150	356	177	400
1800	205	474	235	600
1800	260	573	284	600
1800	370	802	398	800
1800	480	1 031	512	1000
1800	590	1 260	625	1200

Höhe A ↕ [mm]	Breite B ↔ [mm]	Nabenabstand C2 [mm]	Nabenabstand C3 [mm]	Horizontaler Abstand der Wandhalterungen D [mm]	Vertikaler Abstand der Wandhalterungen E [mm]	Position der unteren Wandhalterung F [mm]	Kapazität  [dm³]	Gewicht  [kg]
1200	95	55	1120	55	960	120	2,71	3,99
1200	150	110	1120	110	960	120	4,08	5,90
1200	205	165	1120	165	960	120	5,44	7,81
1200	260	220	1120	220	960	120	6,81	9,72
1200	370	330	1120	330	960	120	9,54	13,54
1200	480	440	1120	440	960	120	12,27	17,35
1200	590	550	1120	550	960	120	15,00	21,18
1800	95	55	1720	55	1 560	120	4,00	5,82
1800	150	110	1720	110	1 560	120	6,01	8,66
1800	205	165	1720	165	1 560	120	8,02	11,51
1800	260	220	1720	220	1 560	120	10,03	14,35
1800	370	330	1720	330	1 560	120	14,06	19,99
1800	480	440	1720	440	1 560	120	18,08	25,63
1800	590	550	1720	550	1 560	120	22,10	31,28

## TECHNISCHE ZEICHNUNG

SX

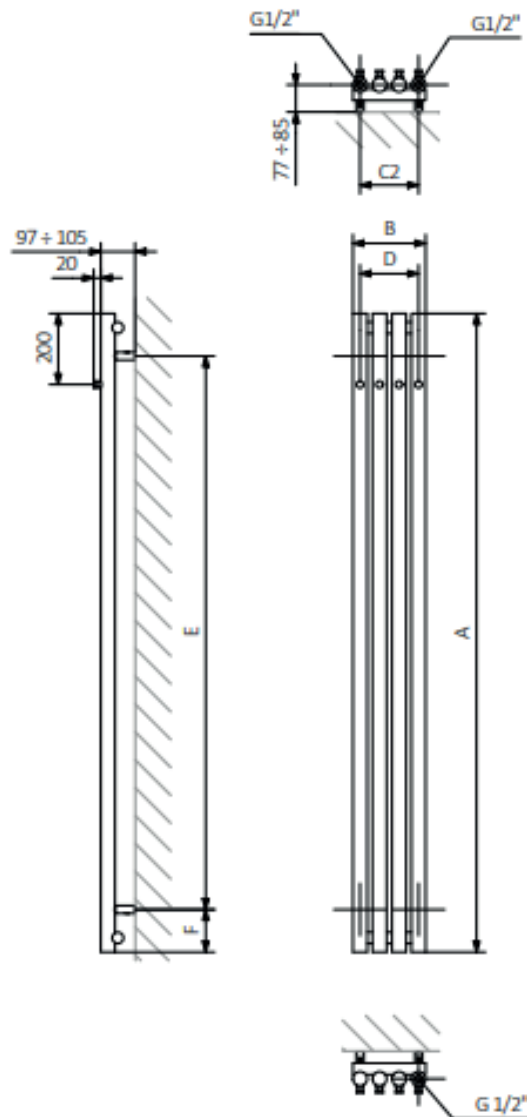

A - Höhe B - Breite C1-C5 - Anschlussabstand D - horizontaler Wandhalterungsabstand E - Vertikaler Wandhalterungsabstand F - Abstand von der Achse der unteren Wandhalterung bis Unterkante des Kollektors

**Kollektor:**    **Rohr:**

