

Angus DW

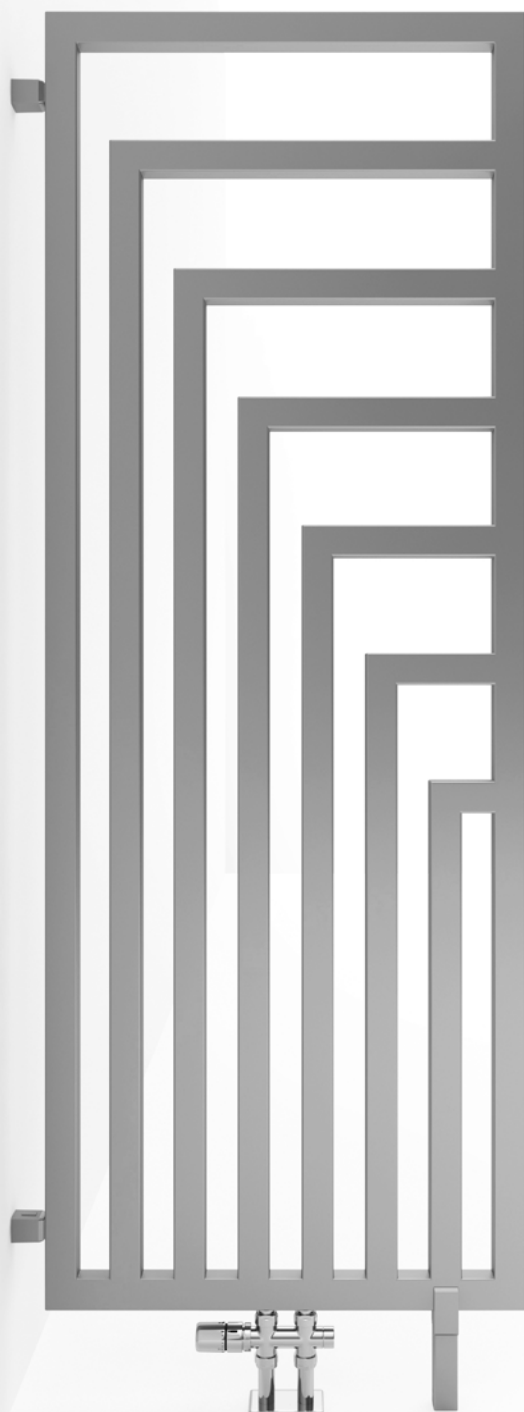

Angus DW 1450↓ × 520↔ ZX
Farbe: Chrome Effect

Set thermostat-verbunddurchgangsventil, rechts, Chrom
Abdeckblende, Chrom

Angus DW

Anschlussstypen

Warmwasserbetrieb

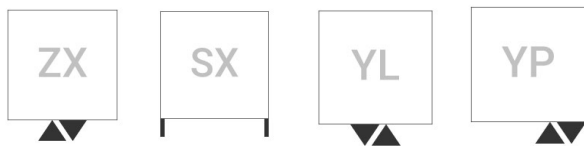

Mischbetrieb

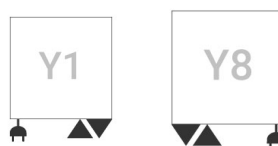

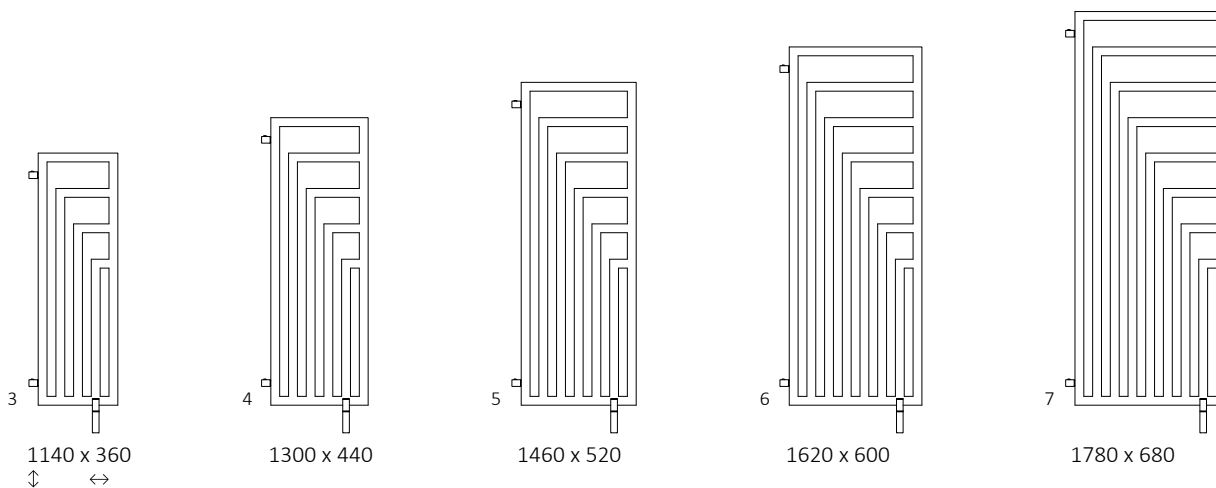

Verfügbare Größen:



Technische Daten

Betriebsdruck: 800 kPa

Maximale Betriebstemperatur: 95°C

A ↕ [mm]	B ↔ [mm]	C1 [mm]	C2 [mm]	75/20°C [W]	55/20°C [W]	 [W]	E [mm]	F [mm]	H [dm ³]	 [kg]	Artikelnummer <small>Handtuchheizkörpercode: 1-5</small>
1140	360	50	320	421	224	400	940	100	5,18	11,50	WGANS114036
1300	440	50	400	557	293	600	1100	100	6,92	15,36	WGANS130044
1460	520	50	480	711	372	800	1260	100	8,88	19,71	WGANS146052
1620	600	50	560	905	472	1000	1420	100	11,07	24,57	WGANS162060
1780	680	50	640	1116	580	1200	1580	100	13,48	29,92	WGANS178068

Angus DW

Technische Zeichnung:

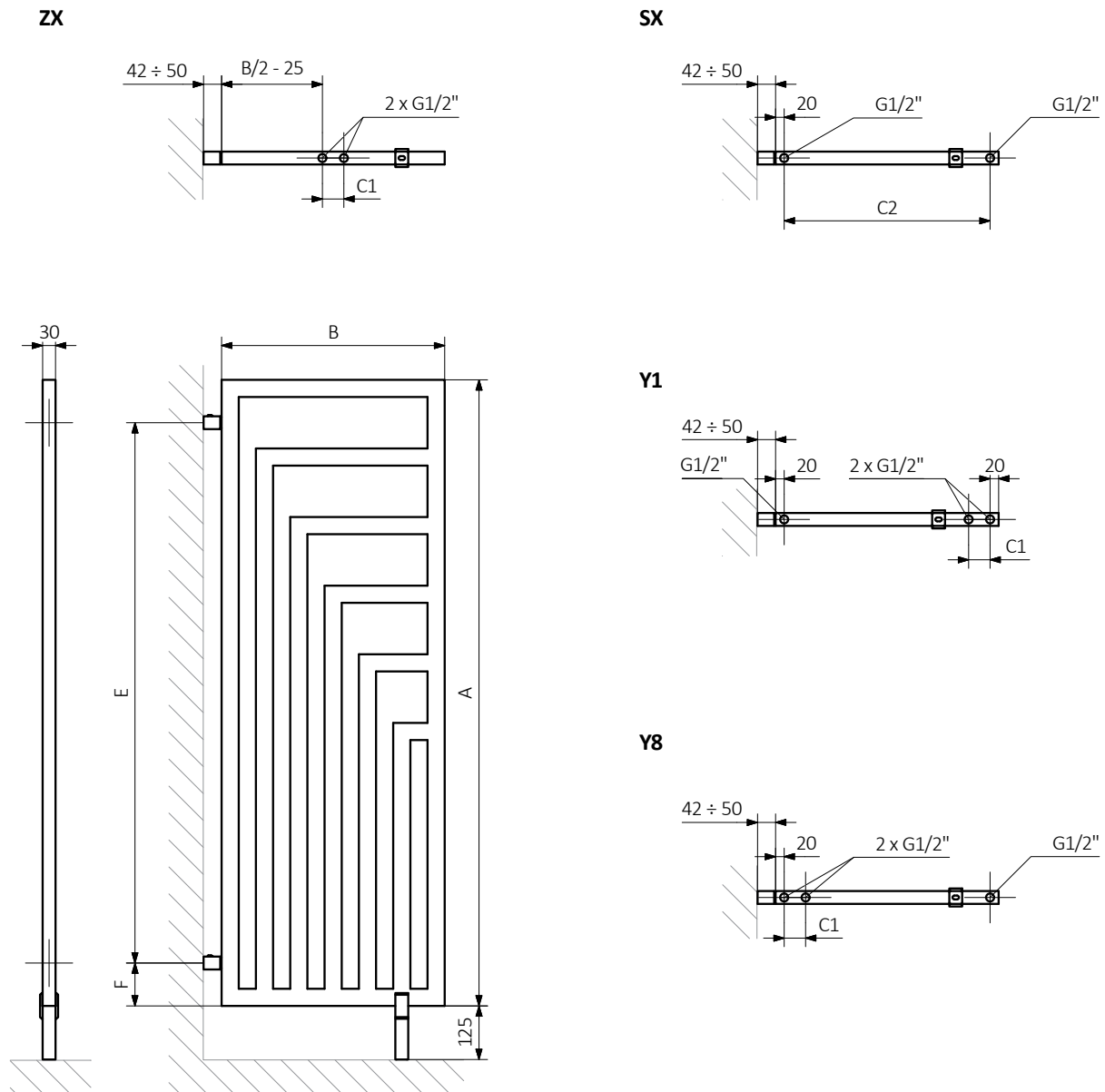

A - Höhe B - Breite C1-C5 - Anschlussabstand D - horizontaler Wandhalterungsabstand E - Vertikaler Wandhalterungsabstand F - Abstand von der Achse der unteren Wandhalterung bis Unterkante des Kollektors

Rohr:

