

Delfin

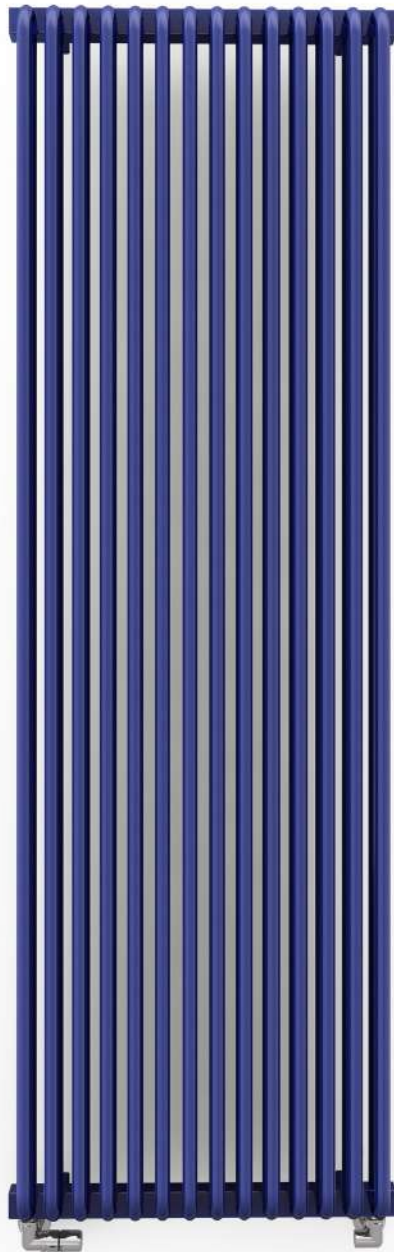

Delfin 1800⇕ × 580⇔ SX
Farbe: RAL 5022

Anschlussgarnitur: Set Winkeleck-Thermostatventil, links, Chrom
Set einteilige Blende, Chrom

Delfin

Standard Anschlussstypen:

A ↕ 440÷2000:

A ↕ 1800÷2000:

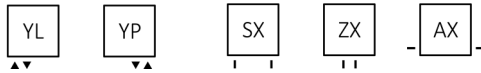

Technische Daten:

Betriebsdruck: 800 kPa

Maximale Betriebstemperatur: 95°C

A ↕ [mm]	B ↔ [mm]	C1 [mm]	C2 [mm]	C3 [mm]	C4 [mm]	75/65/20°C [W]	55/45/20°C [W]	☺ [W]	D [mm]	E [mm]	F [mm]	H [dm²]	📦 [kg]	Artikelnummer <small>Konfigurations code s. 8</small>
440	820	50	780	400	820	705	370	800	710	400	20	6,41	14,30	WGDLF044082
440	1020	50	980	400	1020	885	465	800	910	400	20	8,01	17,82	WGDLF044102
440	1220	50	1180	400	1220	1061	556	1000	1110	400	20	9,60	21,34	WGDLF044122
540	820	50	780	500	820	846	442	800	710	500	20	7,61	16,97	WGDLF054082
540	1020	50	980	500	1020	1057	553	1000	910	500	20	9,50	21,16	WGDLF054102
540	1220	50	1180	500	1220	1264	661	1200	1110	500	20	11,39	25,35	WGDLF054122
640	820	50	780	600	820	986	514	1000	710	600	20	8,80	19,65	WGDLF064082
640	1020	50	980	600	1020	1233	644	1200	910	600	20	10,99	24,50	WGDLF064102
640	1220	50	1180	600	1220	1458	760	1500	1110	600	20	13,19	29,36	WGDLF064122
1800	500	50	460	1760	500	1403	717	-	390	1760	20	13,61	30,48	WGDLF180050
1800	580	50	540	1760	580	1623	830	-	470	1760	20	15,87	35,52	WGDLF180058
2000	500	50	460	1960	500	1556	802	-	390	1960	20	15,04	33,68	WGDLF200050
2000	580	50	540	1960	580	1774	909	-	470	1960	20	17,55	39,26	WGDLF200058

Delfin

Verfügbare Größen:

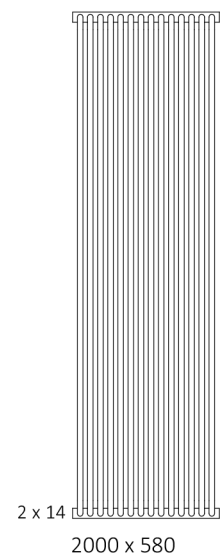
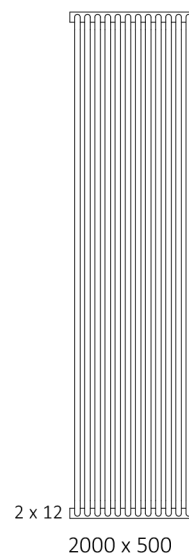
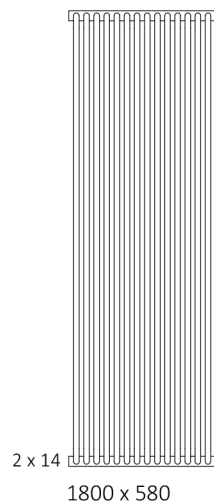
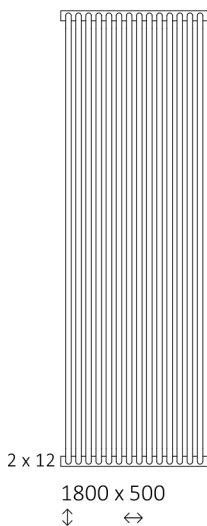
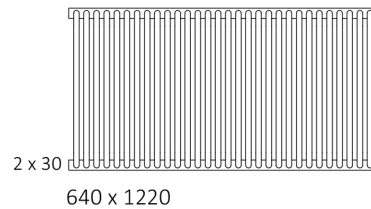
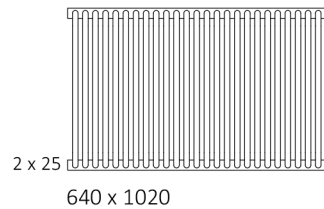
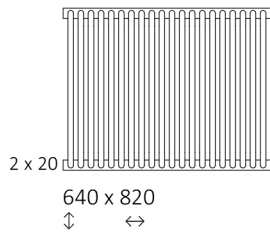
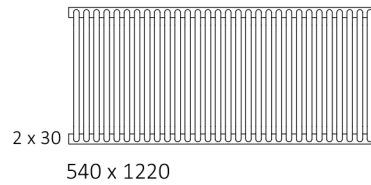
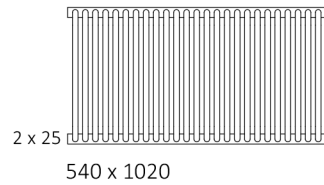
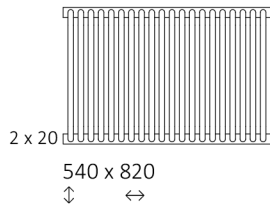
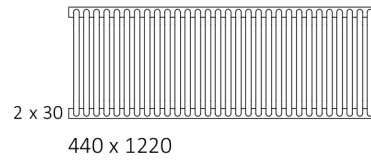
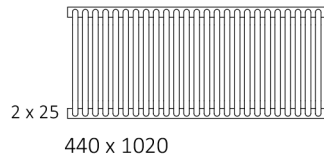
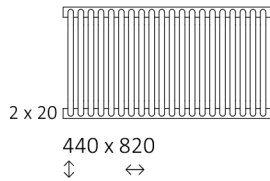

Delfin

Technische Zeichnung:

L6

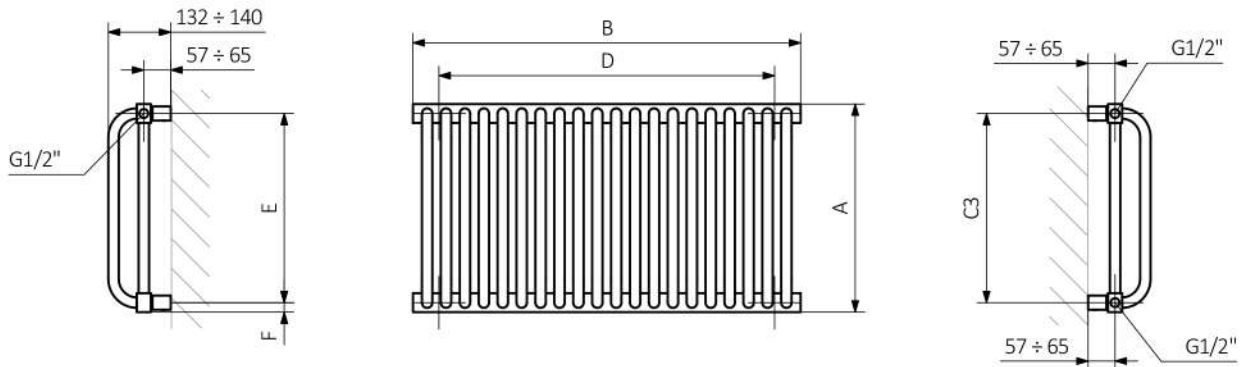

P3

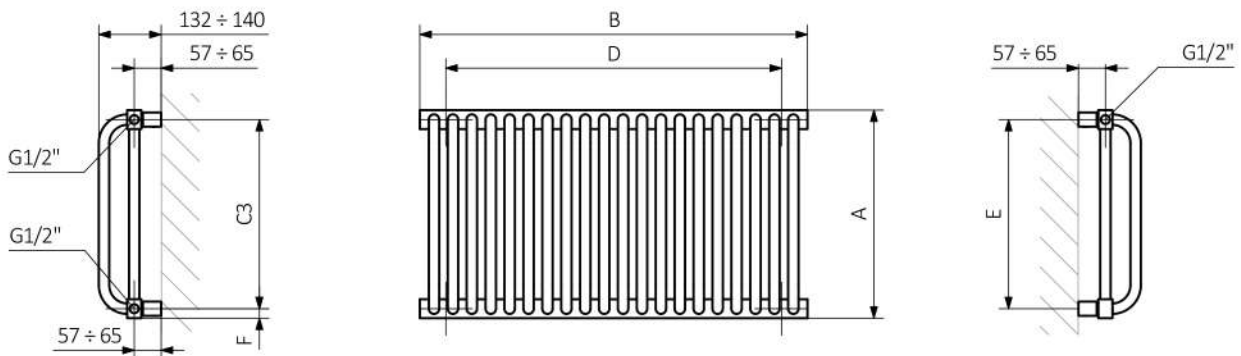

YL

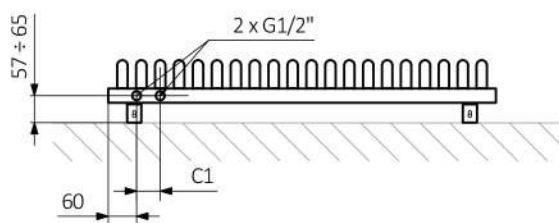

YP

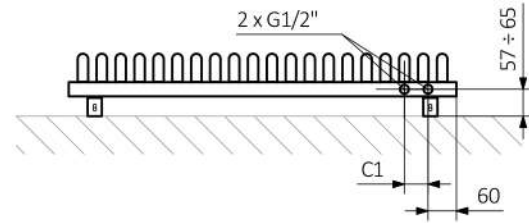

A – Höhe B – Breite C1-C5 – Anschlussabstand D – horizontaler Wandhalterungsabstand E – Vertikaler Wandhalterungsabstand F – Abstand von der Achse der unteren Wandhalterung bis Unterkante des Kollektors

Kollektor :

Rohr :

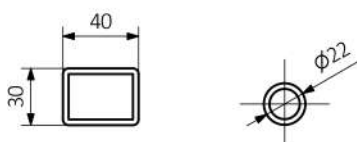

Delfin

Technische Zeichnung:

VL

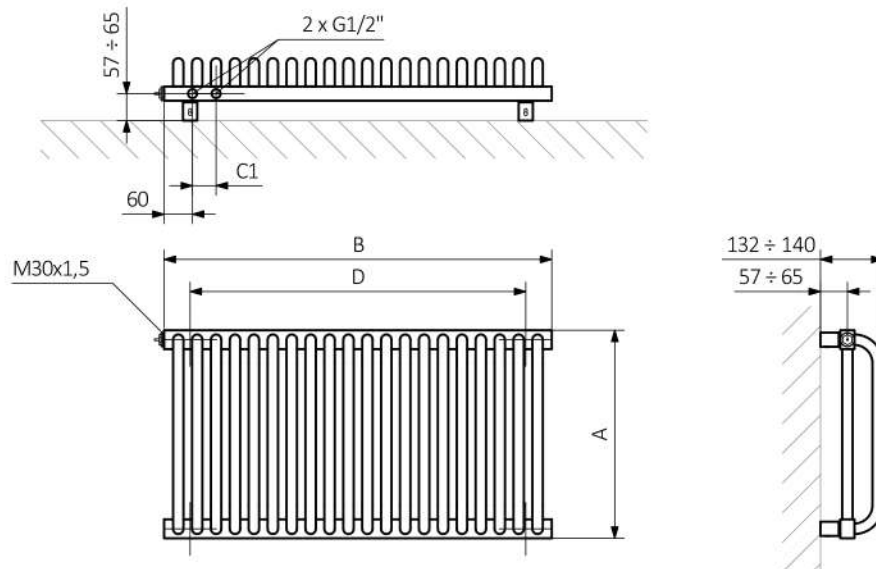

VP

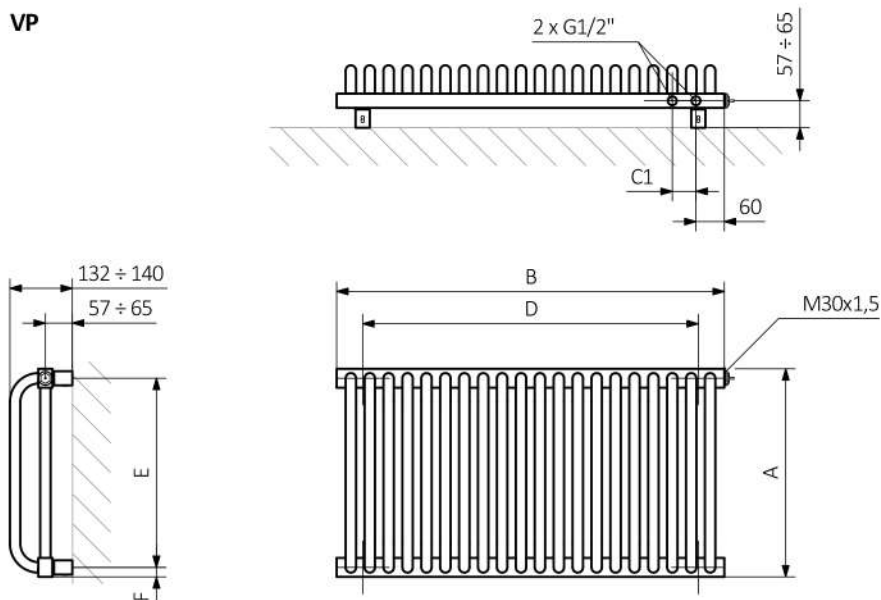

A – Höhe B – Breite C1-C5 – Anschlussabstand D – horizontaler Wandhalterungsabstand E – Vertikaler Wandhalterungsabstand
F – Abstand von der Achse der unteren Wandhalterung bis Unterkante des Kollektors

Kollektor :

Rohr :

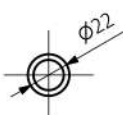
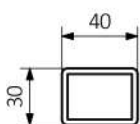

Delfin

Technische Zeichnung:

AX

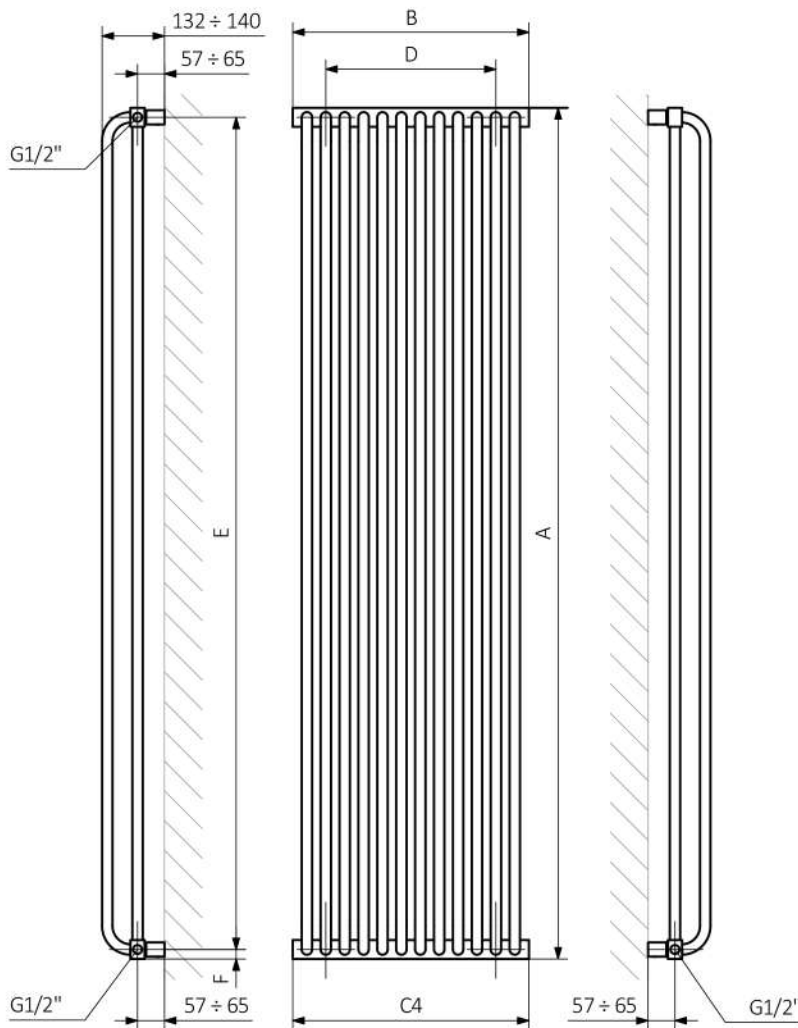

SX

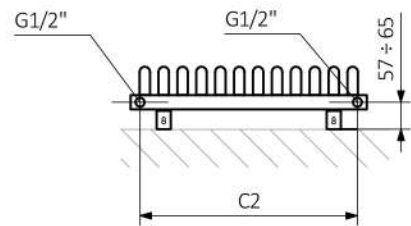

ZX

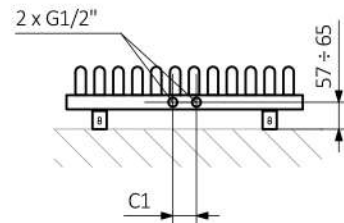

YP

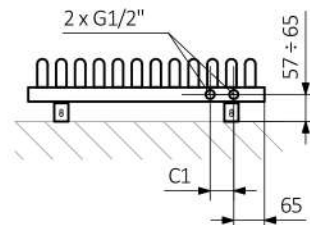

YL

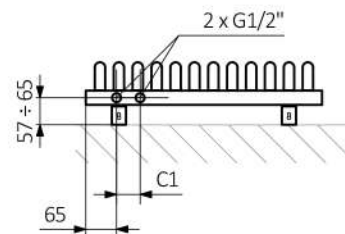

A – Höhe B – Breite C1-C5 – Anschlussabstand D – horizontaler Wandhalterungsabstand E – Vertikaler Wandhalterungsabstand F – Abstand von der Achse der unteren Wandhalterung bis Unterkante des Kollektors

Kollektor :

Rohr :

