

Rolo Towel





PREDISPOSIZIONI

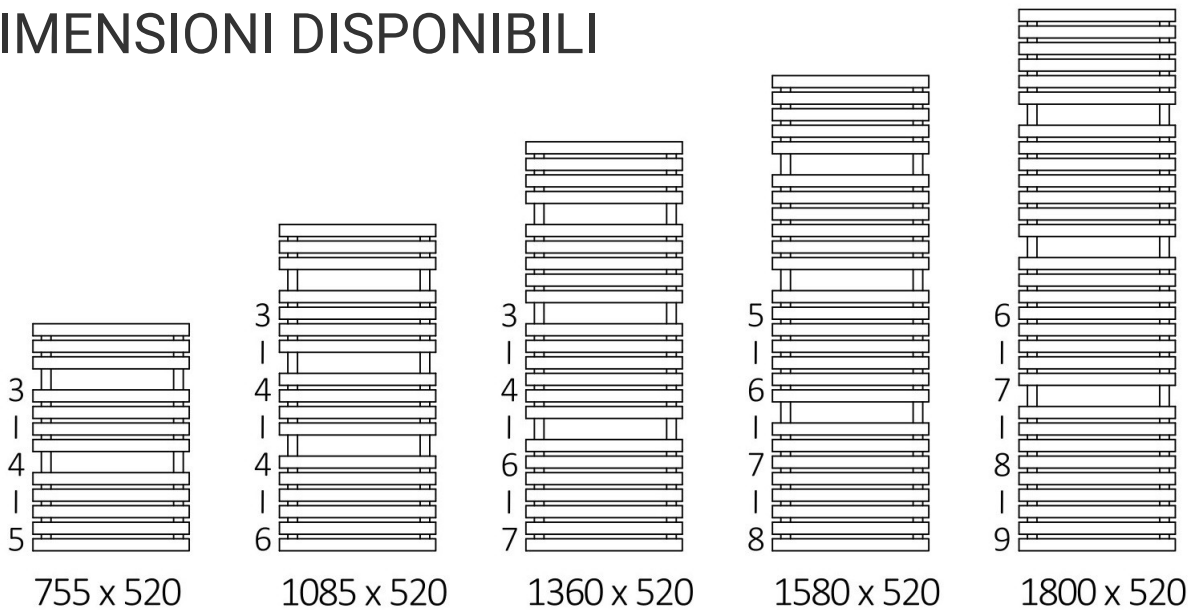

DIMENSIONI DISPONIBILI



INFORMAZIONI TECNICHE

A ↑ [mm]	B ↔ [mm]	C2 [mm]	 [W]	 [kg]
755	520	440	400	12.34
1085	520	440	600	17.45
1360	520	440	800	22.38
1580	520	440	1000	26.32
1800	520	440	1000	30.27

Rolo Towel

E8

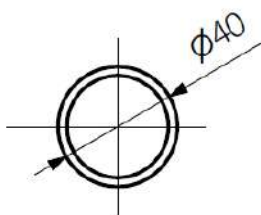
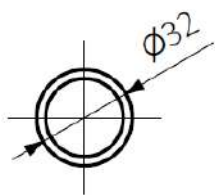
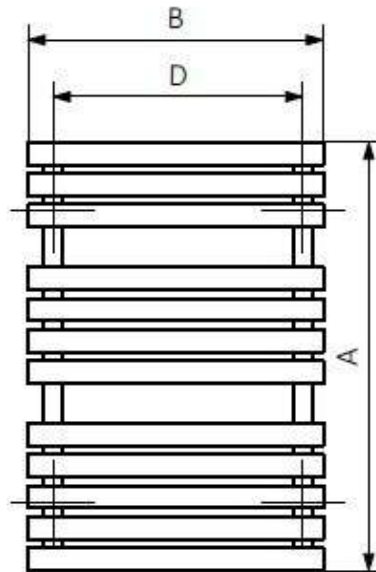
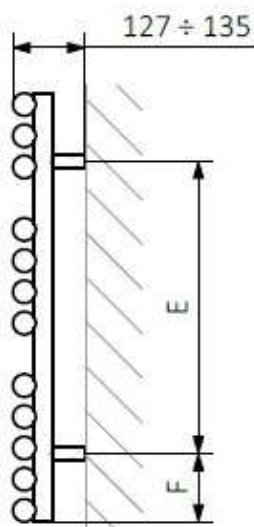
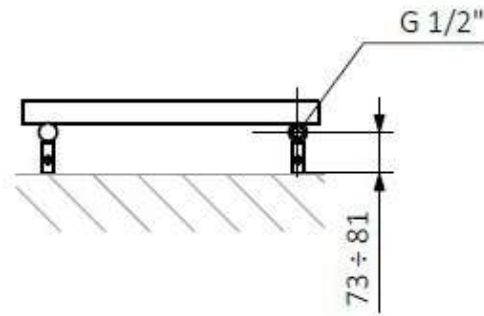

Rolo Towel

E1

