

Tune HSD

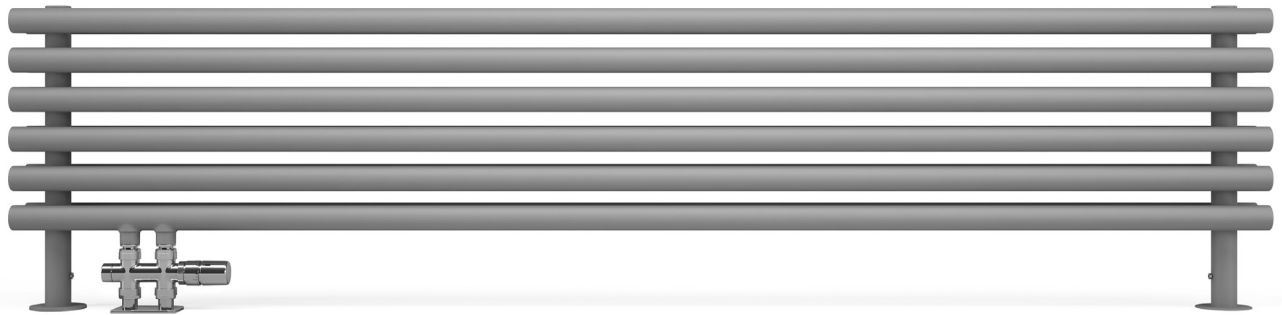

Farben
im Preis



Tune HSD 390↓ × 1400↔ YL
Farbe: Silver Matt

Set thermostat-verbunddurchgangsventil, links, Chrom
Abdeckblende, Chrom

Tune HSD

Standard Anschlusstypen:

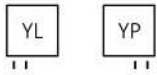

Verfügbare Größen:

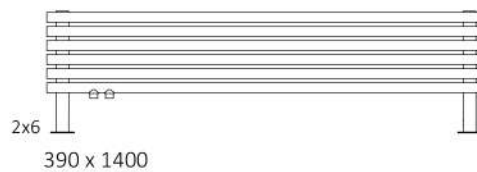
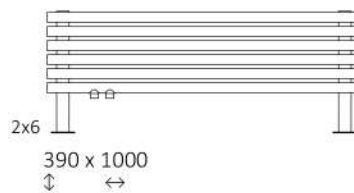
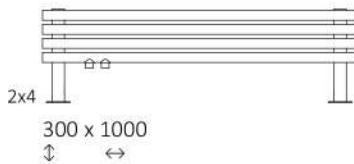

Technische Daten:

Betriebsdruck: 1000 kPa

Maximale Betriebstemperatur: 95°C

A ↕ [mm]	B ↔ [mm]	C1 [mm]	75/65/20°C [W]	55/45/20°C [W]	D [mm]	H [dm³]	 [kg]	Artikelnummer <small>Konfigurations code s. 5</small>
300	1000	50	421	229	900	6,11	9,30	WGTUH030100
300	1400	50	589	320	1300	8,32	12,34	WGTUH030140
390	1000	50	564	305	900	9,05	13,58	WGTUH039100
390	1400	50	790	428	1300	12,35	18,15	WGTUH039140

Tune HSD

Technische Zeichnung:

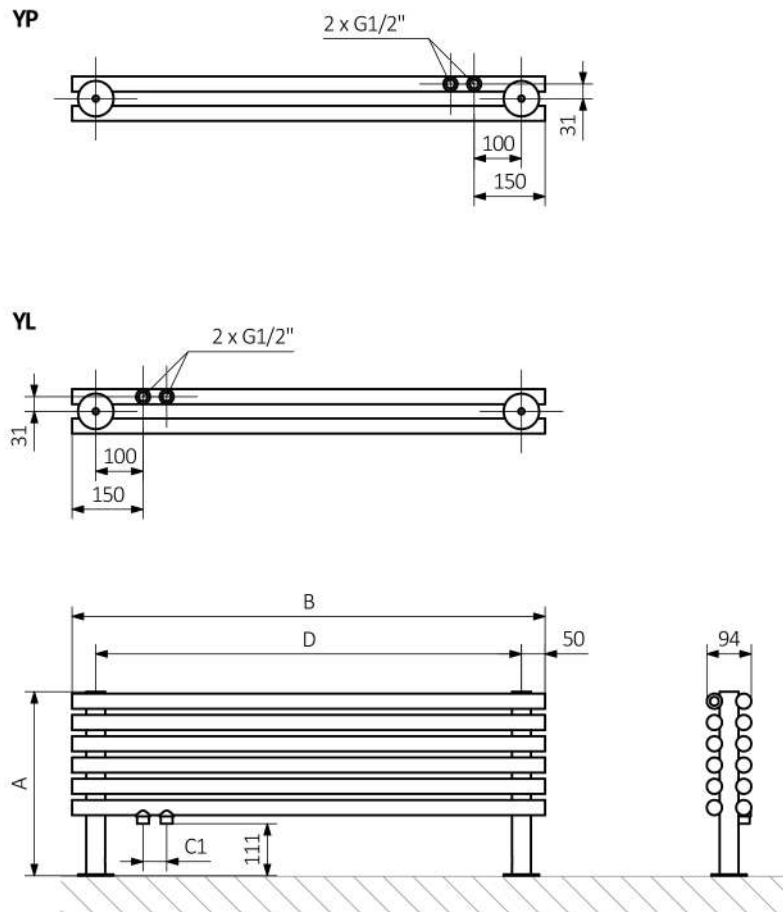

A – Höhe B – Breite C1-C5 – Anschlussabstand D – horizontaler Wandhalterungsabstand E – Vertikaler Wandhalterungsabstand
F – Abstand von der Achse der unteren Wandhalterung bis Unterkante des Kollektors

Kollektor :

