

# Forte V20



COULEUR  
AU CHOIX



## Radiateur

Forte V20 1600↕ × 514↔ LP,  
couleur : Metallic Grey,  
code radiateur : TG20F160051 KMGRLP

### ◀ Vannes et accessoires

Set Thermostat-Eckventil  
Ensemble cache tube et rosace de masquage

### ▼ Vannes et accessoires

Ensemble vanne thermostatique angulaire  
Ensemble cache tube et rosace de masquage



RAL 9005 MAT



RAL 9016



METALLIC GREY

# Forte V20



COULEUR  
AU CHOIX

## DIMENSIONS

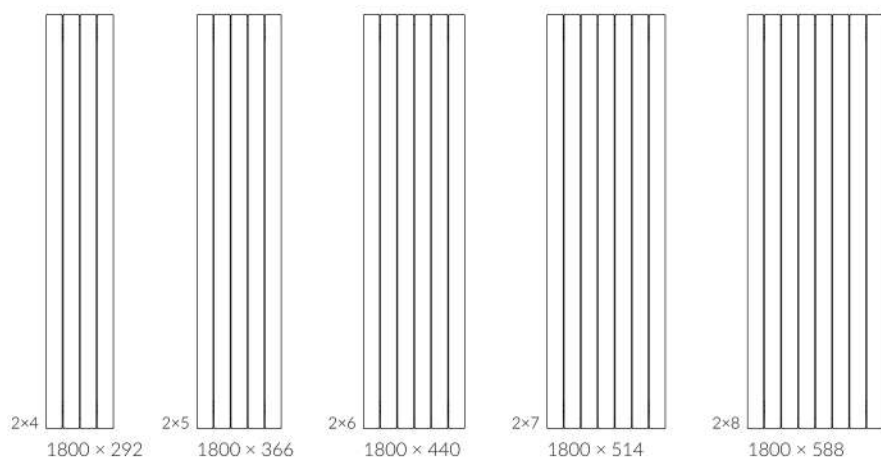
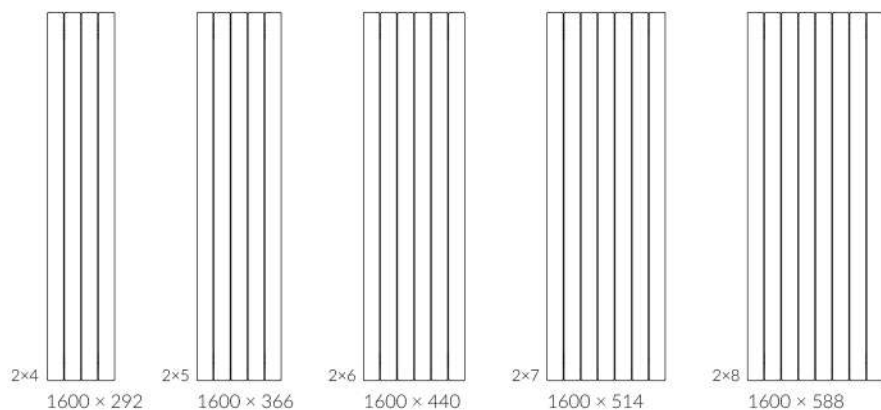
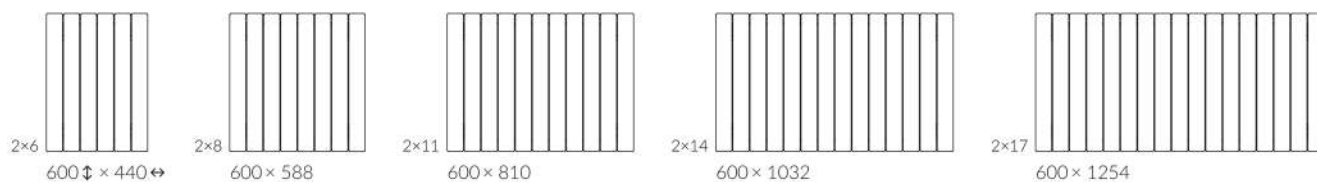
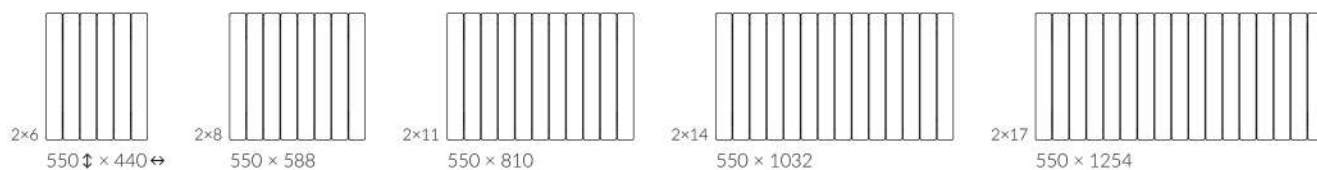

# Forte V20



Raccordements:

Hauteur 550–600 mm



Hauteur 1600–1800 mm

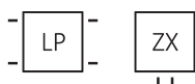

Hauteur A ↓ [mm]	Largeur B ↔ [mm]	Puissance – peinture époxy		Code produit <a href="#">... Code de configuration p. 6</a>
		75/65/20°C [W]	55/45/20°C [W]	
550	440	429	219	TG20F055044...
550	588	571	292	TG20F055058...
550	810	786	402	TG20F055081...
550	1032	1000	511	TG20F055103...
550	1254	1214	621	TG20F055125...
600	440	464	237	TG20F060044...
600	588	619	316	TG20F060058...
600	810	851	435	TG20F060081...
600	1032	1083	553	TG20F060103...
600	1254	1315	672	TG20F060125...
1600	292	739	370	TG20F160029...
1600	366	924	463	TG20F160036...
1600	440	1108	555	TG20F160044...
1600	514	1293	648	TG20F160051...
1600	588	1478	741	TG20F160058...
1800	292	814	407	TG20F180029...
1800	366	1017	508	TG20F180036...
1800	440	1221	610	TG20F180044...
1800	514	1424	712	TG20F180051...
1800	588	1628	814	TG20F180058...



# Forte V20

 COULEUR  
 AU CHOIX

## DIMENSIONS ET INFORMATIONS TECHNIQUES

Pression du travail : 450 kPa

Température maximale du travail : 95°C

Hauteur A ↕ [mm]	Largeur B ↔ [mm]	Profondeur G [mm]	Écartement des raccordements C1 [mm]	Écartement des raccordements C3 [mm]	Écartement des raccordements C4 [mm]	Écartement des raccordements C5 [mm]	Écartement horizontal des consoles D [mm]	Écartement vertical des consoles E [mm]	Position de la console inférieure F [mm]	Capacité  [dm <sup>3</sup> ]	Poids  [kg]
550	440	93	50	500	440	—	296	377	107	4,33	10,93
550	588	93	50	500	588	—	444	377	107	5,78	14,62
550	810	93	50	500	810	—	666	377	107	7,94	20,09
550	1032	93	50	500	1032	—	888	377	107	10,11	25,57
550	1254	93	50	500	1254	—	1110	377	107	12,28	31,05
600	440	93	50	550	440	—	296	427	107	4,72	12,53
600	588	93	50	550	588	—	444	427	107	6,30	15,74
600	810	93	50	550	810	—	666	427	107	8,66	21,63
600	1032	93	50	550	1032	—	888	427	107	11,02	27,53
600	1254	93	50	550	1254	—	1110	427	107	13,38	33,43
1600	292	93	—	1550	292	50	148	1427	107	8,35	19,56
1600	366	93	—	1550	366	50	222	1427	107	10,44	24,44
1600	440	93	—	1550	440	50	296	1427	107	12,52	29,33
1600	514	93	—	1550	514	50	370	1427	107	14,61	34,22
1600	588	93	—	1550	588	50	444	1427	107	16,70	39,11
1800	292	93	—	1750	292	50	148	1627	107	9,39	21,90
1800	366	93	—	1750	366	50	222	1627	107	11,74	27,36
1800	440	93	—	1750	440	50	296	1627	107	14,08	32,84
1800	514	93	—	1750	514	50	370	1627	107	16,43	38,31
1800	588	93	—	1750	588	50	444	1627	107	18,78	43,78

# Forte V20

## DESSIN TECHNIQUE

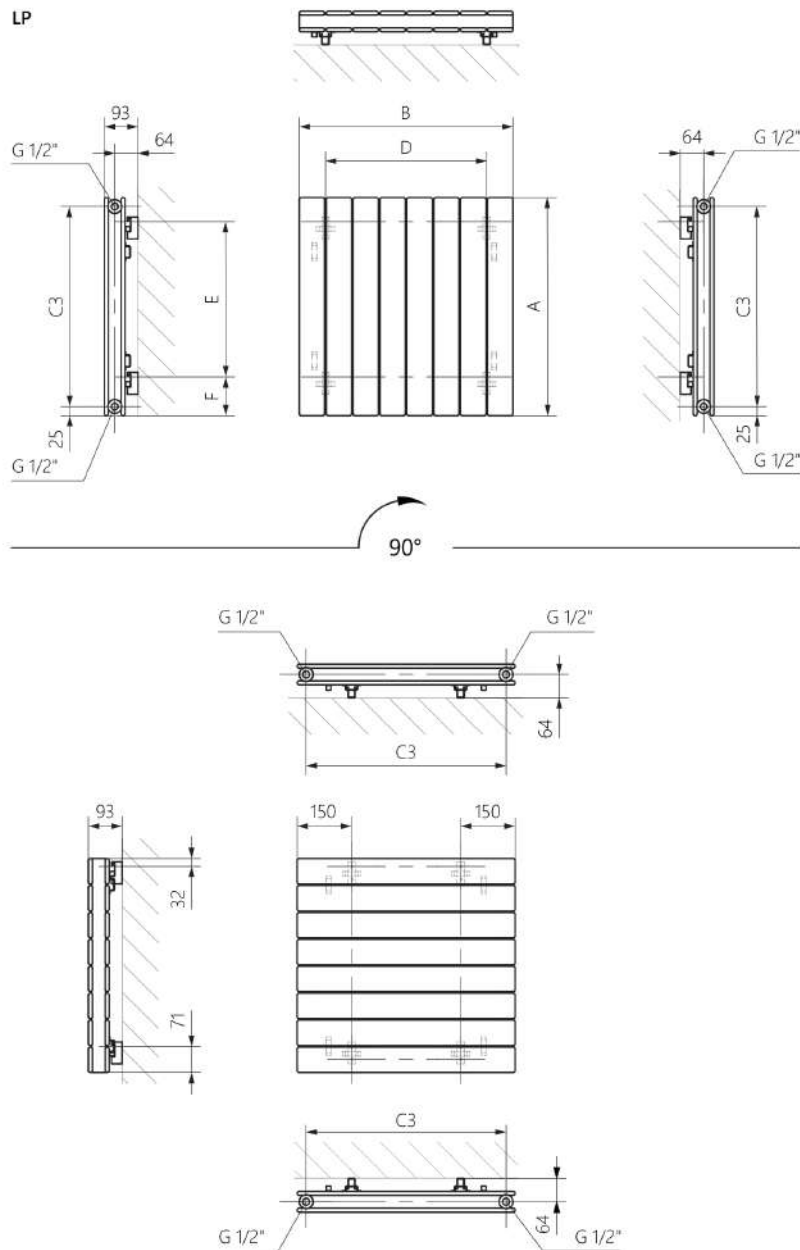

A – Hauteur B – Largeur C1-C5 – espacement des connexions D – espacement horizontal des attaches E – espacement vertical des attaches F – distance de l'axe inférieur des attaches au bord inférieur du collecteur

Collector :

Tube :

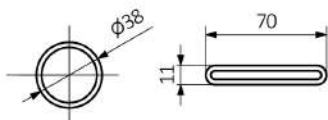

# Forte V20



COULEUR  
AU CHOIX

## DESSIN TECHNIQUE

VL

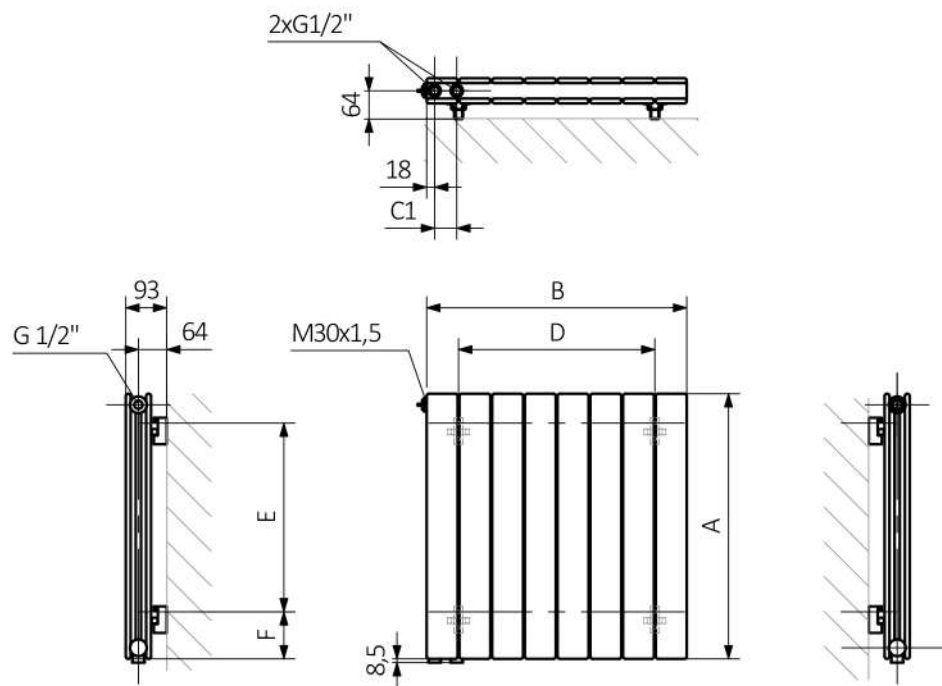

A – Hauteur B – Largeur C1-C5 – espacement des connexions D – espacement horizontal des attaches E – espacement vertical des attaches F – distance de l'axe inférieur des attaches au bord inférieur du collecteur

Collector :

Tube :

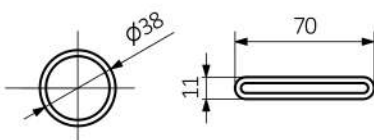

# Forte V20



COULEUR  
AU CHOIX

## DESSIN TECHNIQUE

VP

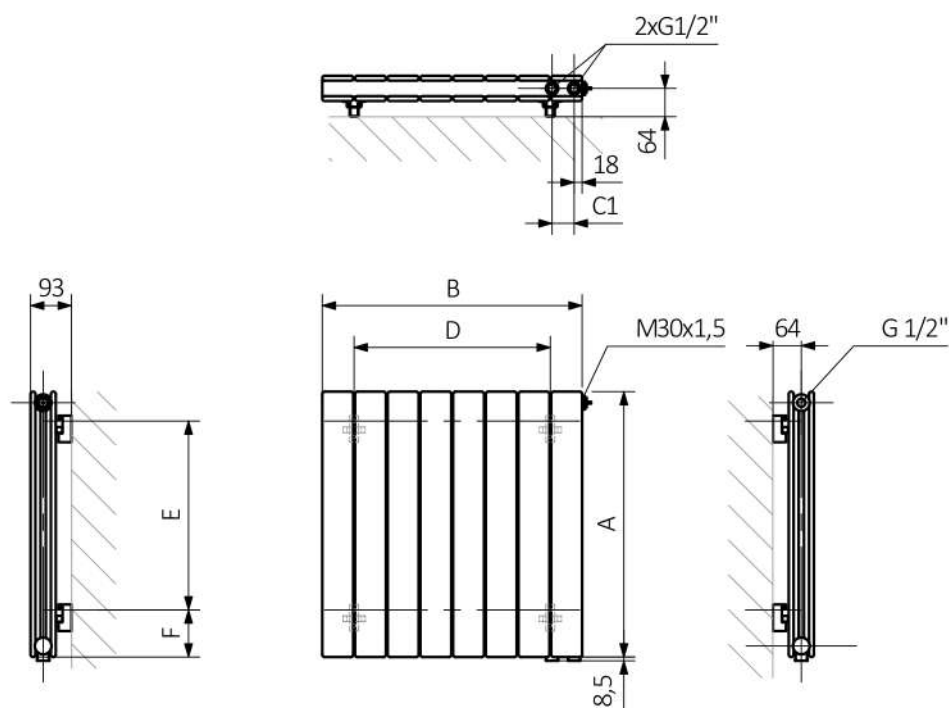

A – Hauteur B – Largeur C1-C5 – espacement des connexions D – espacement horizontal des attaches E – espacement vertical des attaches F – distance de l'axe inférieur des attaches au bord inférieur du collecteur

**Collector :**

**Tube :**

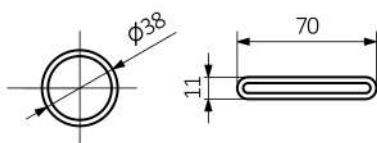

# Forte V20

## DESSIN TECHNIQUE

ZX

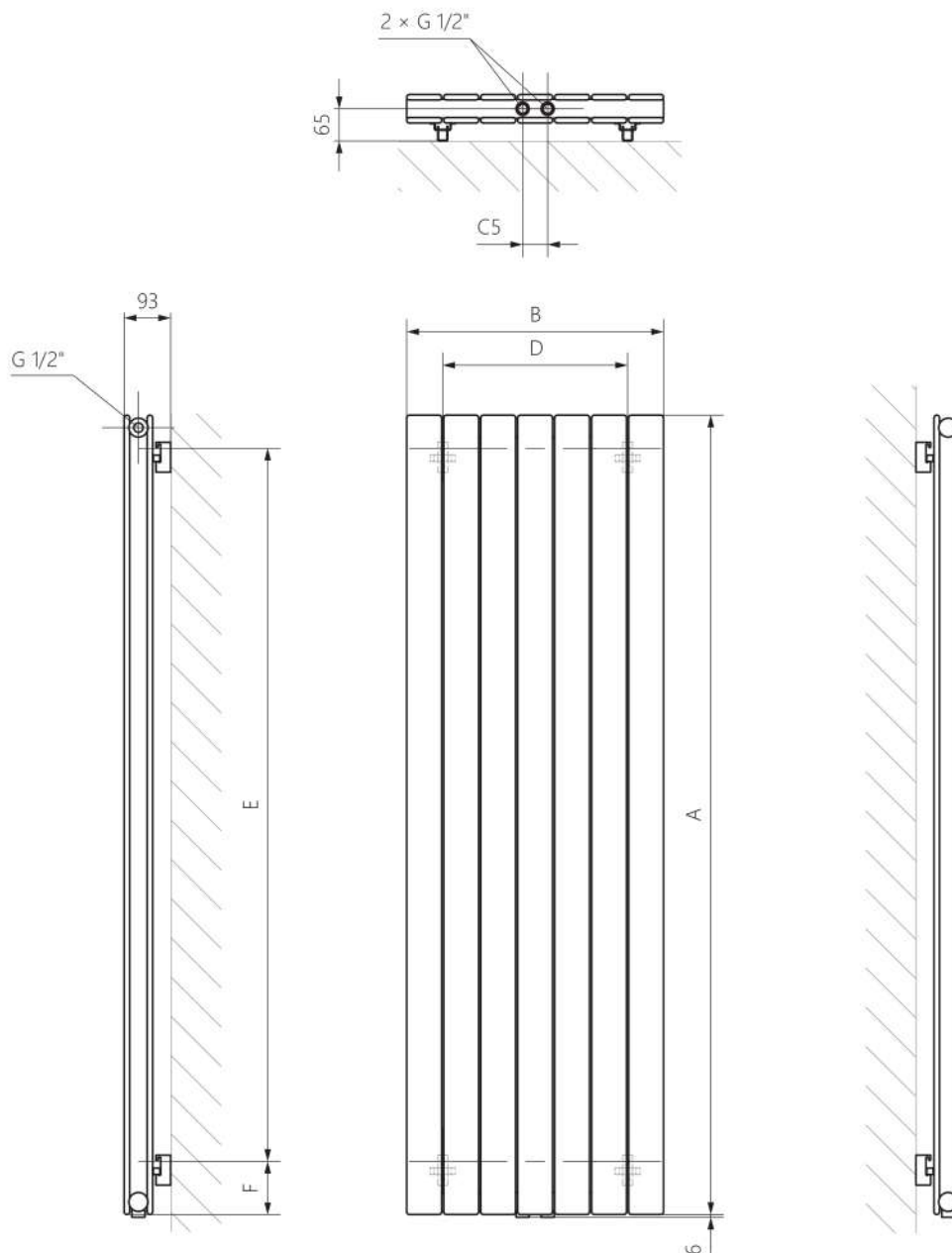

A – Hauteur B – Largeur C1-C5 – espacement des connexions D – espacement horizontal des attaches E – espacement vertical des attaches F – distance de l'axe inférieur des attaches au bord inférieur du collecteur

**Collector :**

**Tube :**

