

Rolo Room H



RACCORDEMENTS



EAU CHAUDE et MIXTE



DIMENSIONS DISPONIBLES

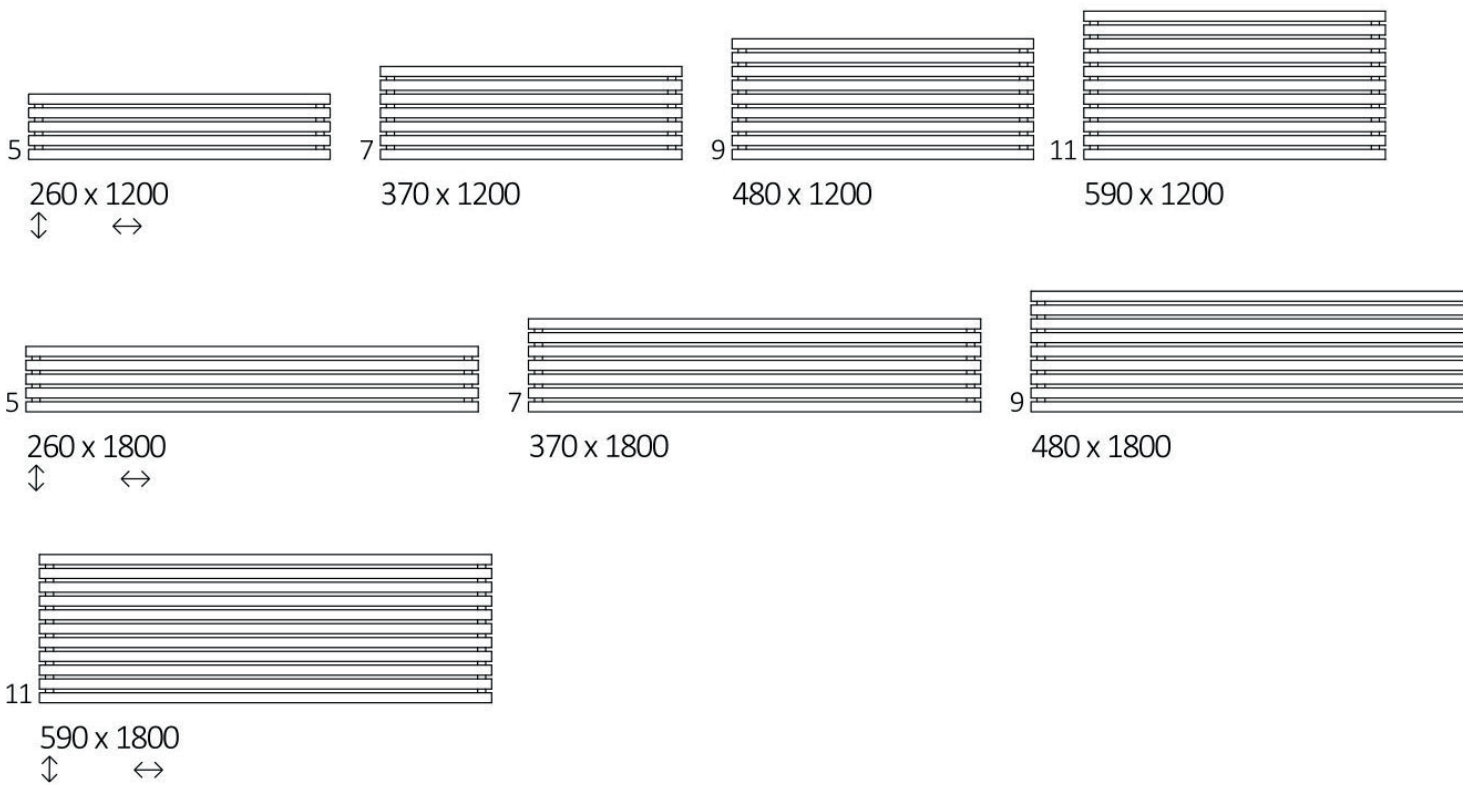





DONNEES TECHNIQUES

Pression du travail 1000 kPa

Température maximale du travail à 95°C

A ↓ [mm]	B ↔ [mm]	C1[mm]	C2[mm]	C3[mm]	C4[mm]	M[W]	m[W]
260	1200	50	1120	220	1200	386	207
260	1800	50	1720	220	1800	579	311
370	1200	50	1120	330	1200	554	300
370	1800	50	1720	330	1800	831	451
480	1200	50	1120	440	1200	703	386
480	1800	50	1720	440	1800	1055	579
590	1200	50	1120	550	1200	832	463
590	1800	50	1720	550	1800	1247	693

 [W]	D[mm]	E[mm]	F[mm]	 [dm ³]	 [kg]
400	960	110	75	6.81	9.51
600	1560	110	75	10.03	13.94
500	960	220	75	9.54	13.33
800	1560	220	75	14.06	19.53
800	960	330	75	12.27	17.15
1000	1560	330	75	18.08	25.12
800	960	440	75	15.00	20.97
1200	1560	440	75	22.10	30.71

DESSINS TECHNIQUES

LP

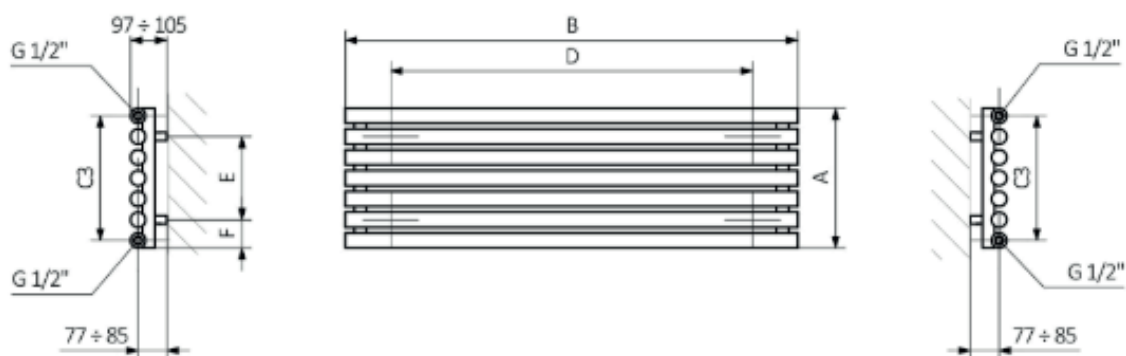

A – Hauteur B – Largeur D – espacement horizontal des attaches E – espacement vertical des attaches
F – distance de l'axe inférieur des attaches au bord inférieur du collecteur

LX

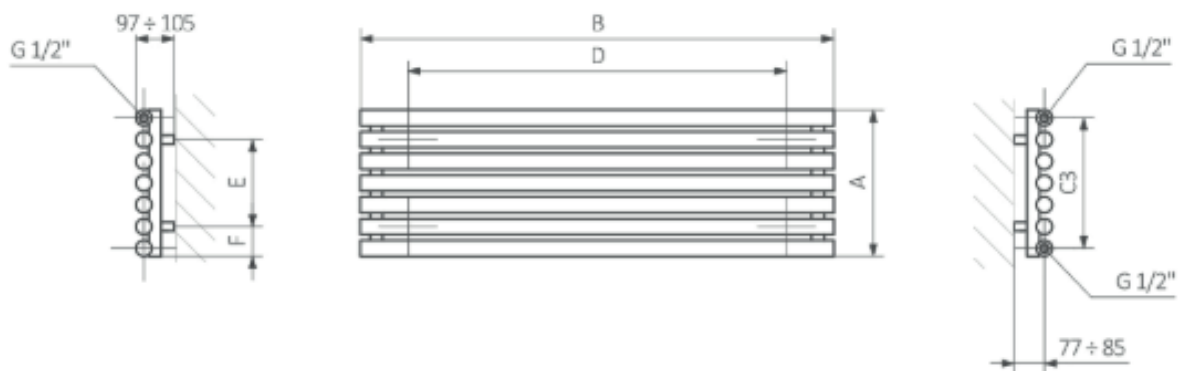

A – Hauteur B – Largeur D – espacement horizontal des attaches E – espacement vertical des attaches
F – distance de l'axe inférieur des attaches au bord inférieur du collecteur

PX

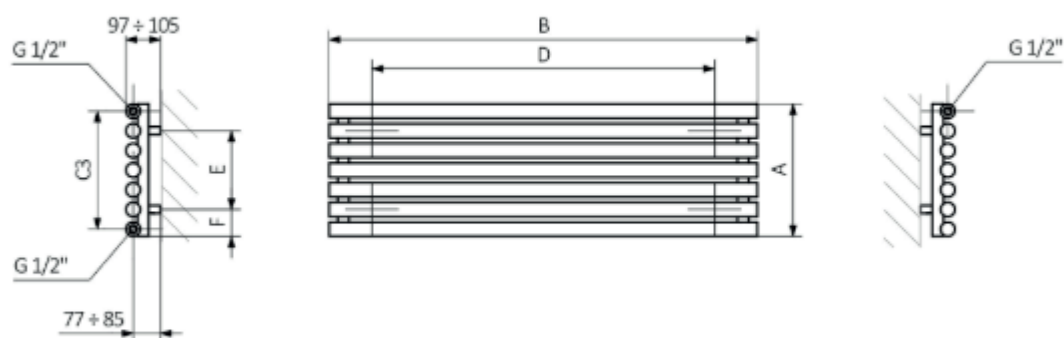

A – Hauteur B – Largeur D – espacement horizontal des attaches E – espacement vertical des attaches
 F – distance de l'axe inférieur des attaches au bord inférieur du collecteur

SX

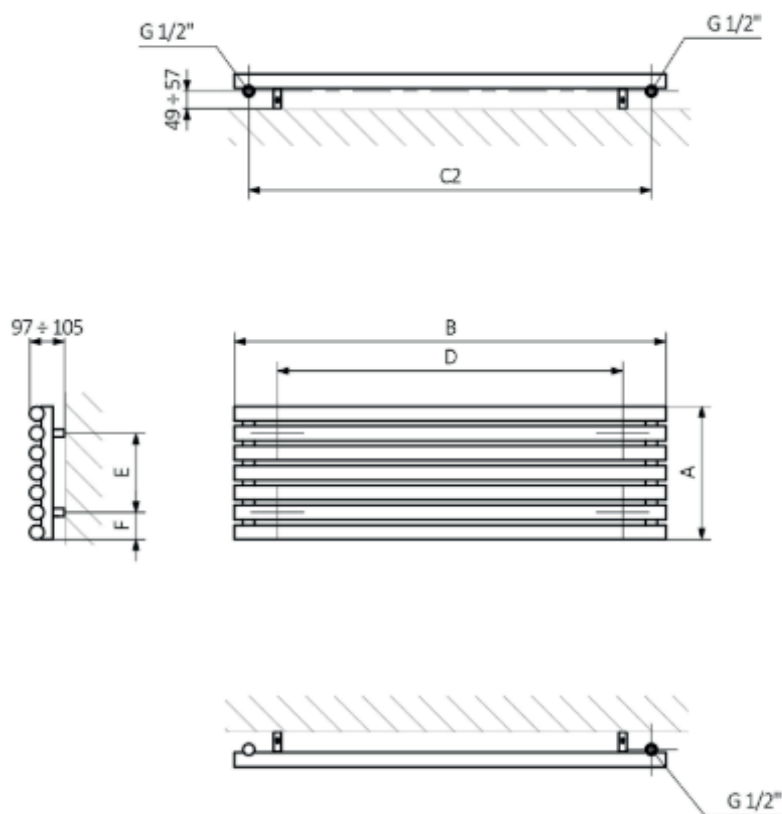

A – Hauteur B – Largeur D – espacement horizontal des attaches E – espacement vertical des attaches
 F – distance de l'axe inférieur des attaches au bord inférieur du collecteur

Collector :

Tube :

