

Ribbon Vertical

ENERGY DRINK // 1720 — 390 // 50 mm connection valve + “Noble” thermostatic head

LUX

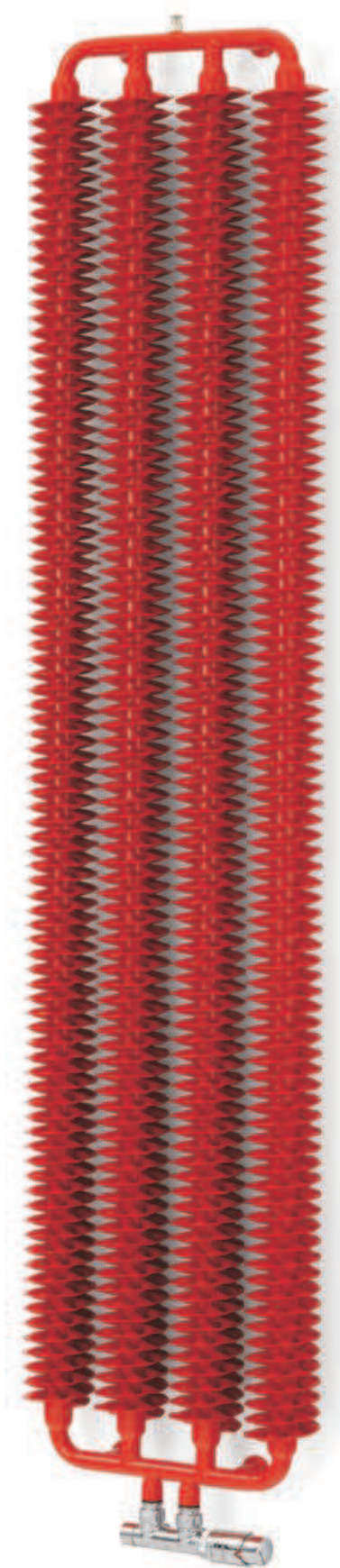

DESIGN: Bartłomiej Drabik



Vertical

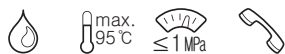





Standard connections:

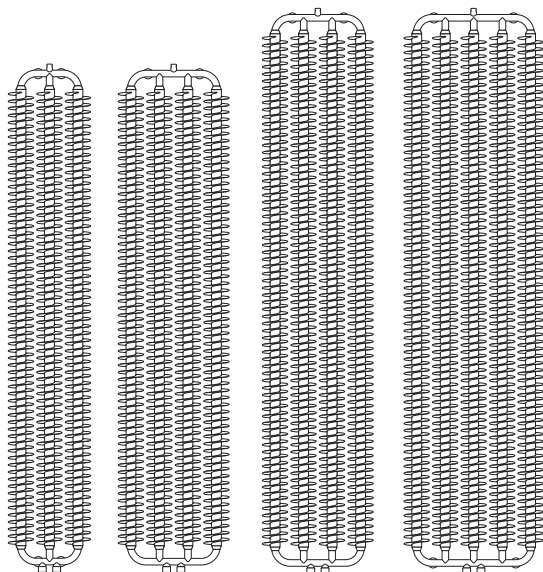

Sizes available:



A [mm]	B [mm]	C [mm]	C' [mm]		75/65/20 [W]	55/45/20 [W]		D [mm]	E [mm]	F [mm]		
1720	290	50	–	RAL+TT	660	337	–	80	1672	36	3,22	24,88
1720	390	50	–	RAL+TT	872	445	–	180	1672	36	4,2	33,1
1920	390	50	–	RAL+TT	989	505	–	180	1872	36	4,7	37,1
1920	490	50	–	RAL+TT	1240	633	–	280	1872	36	5,8	46,4

Ribbon vertical

ZX

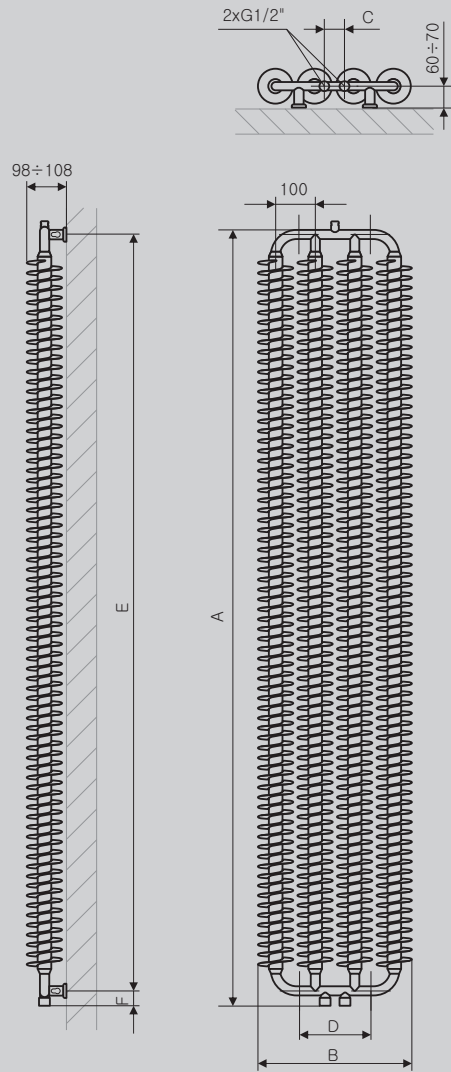

Horizontal

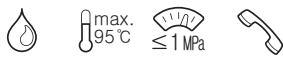

Standard connections:

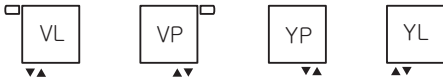

Sizes available:

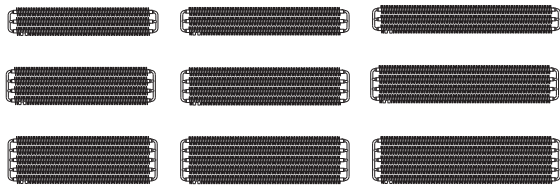

Horizontal selfstanding





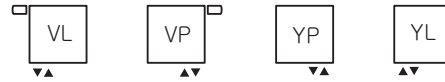

Standard connections:

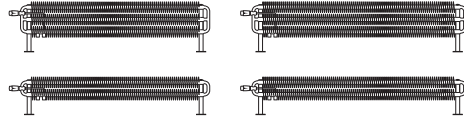

Sizes available:



A	B	C	C'		75/65/20	55/45/20		D	E	F		
[mm]	[mm]	[mm]	[mm]		[W]	[W]	[W]	[mm]	[mm]	[mm]	[dm³]	[Kg]
Horizontal												
290	1540	50	-	RAL+TT	1028	525	-	1400	200	43	2,9	22,9
290	1740	50	-	RAL+TT	1172	598	-	1600	200	43	3,3	25,9
290	1940	50	-	RAL+TT	1316	672	-	1800	200	43	3,6	28,9
390	1540	50	-	RAL+TT	1279	653	-	1400	300	43	3,8	30,0
390	1740	50	-	RAL+TT	1459	744	-	1600	300	43	4,3	34,0
390	1940	50	-	RAL+TT	1638	836	-	1800	300	43	4,8	38,0
490	1540	50	-	RAL+TT	1485	758	-	1400	400	43	4,6	37,1
490	1740	50	-	RAL+TT	1693	864	-	1600	400	43	5,3	42,1
490	1940	50	-	RAL+TT	1901	970	-	1800	400	43	5,9	47,0
Horizontal selfstanding												
190	1540	50	-	RAL+TT	1371	699	-	1400	-	-	3,8	30,0
190	1740	50	-	RAL+TT	1563	797	-	1600	-	-	4,3	34,0
290	1540	50	-	RAL+TT	1919	979	-	1400	-	-	5,5	44,2
290	1740	50	-	RAL+TT	2188	1116	-	1600	-	-	6,3	50,2

Ribbon horizontal

VL

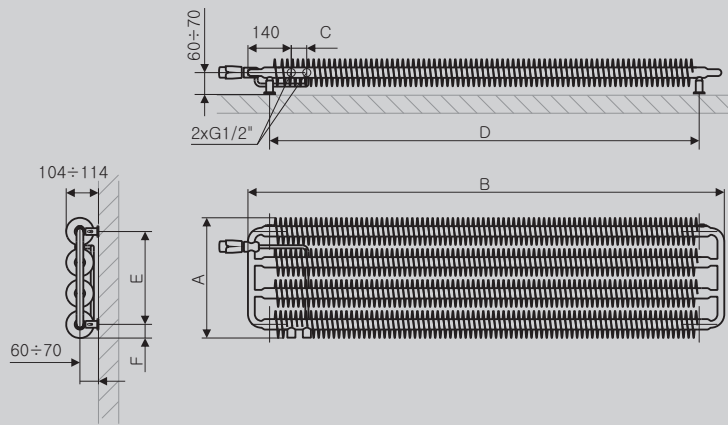

YL

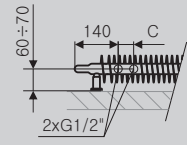

VP

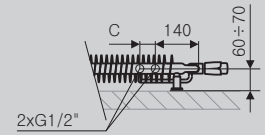

YP

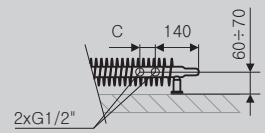

Ribbon horizontal selfstanding

VL

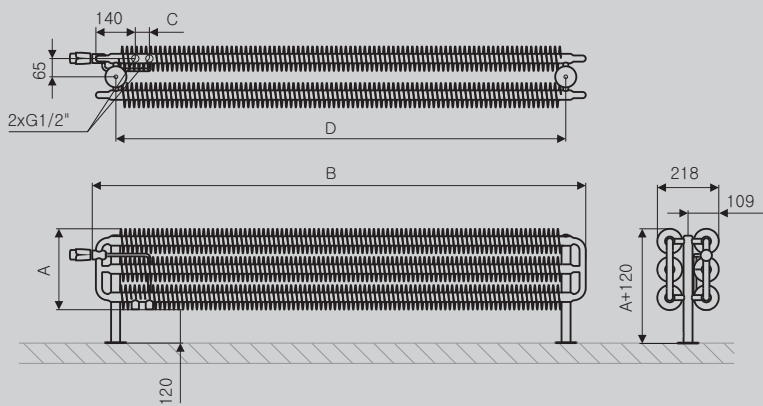

YL

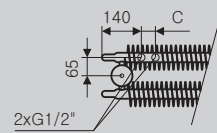

VP

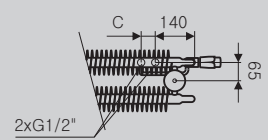

YP

