

Rolo Towel



Rolo Towel



Predisposizioni

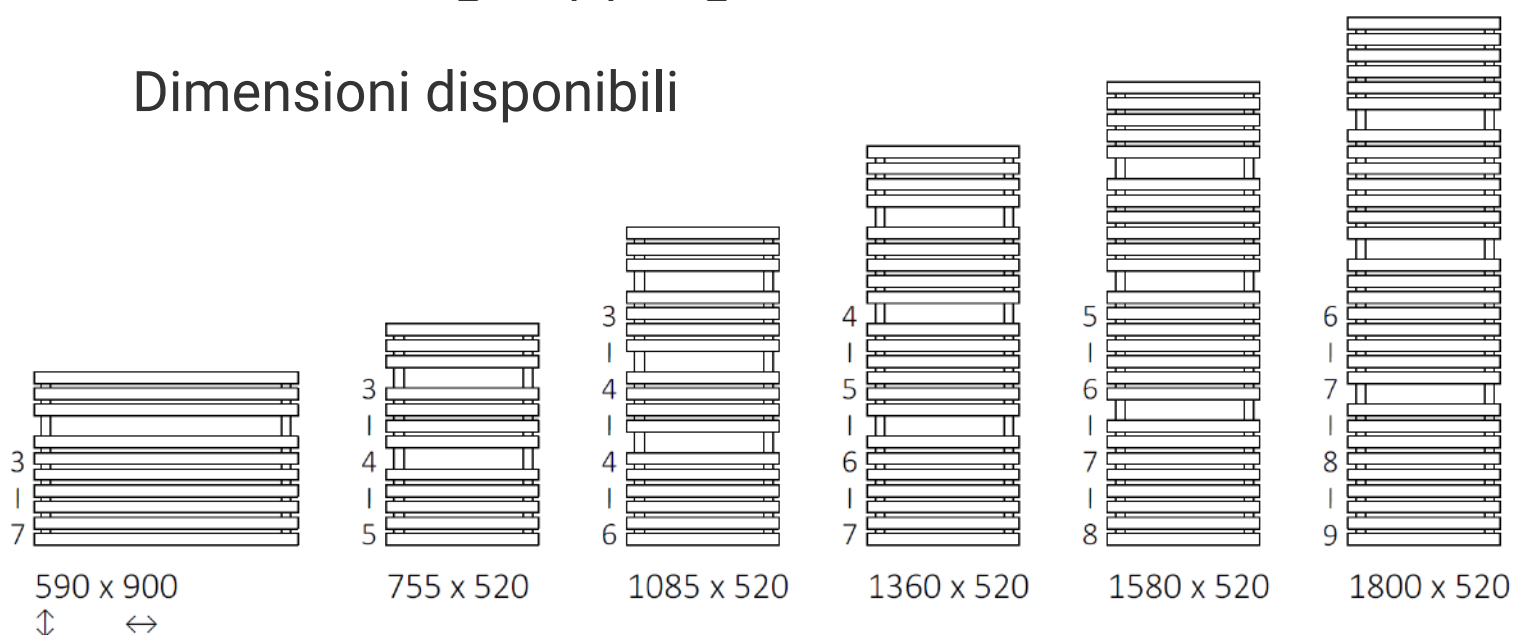

Dimensioni disponibili



Informazioni tecniche :

A ↓ [mm]	B ↔ [mm]	C2 [mm]	75/65/20°C [W]	55/45/20°C [W]	 [W]	 [W]	D [mm]	E [mm]	F [mm]	 [kg]
590	900	820	587	321	600	600	820	350	120	15.8
755	520	440	467	252	400	500	440	515	120	12.34
1085	520	440	619	333	600	600	440	845	120	17.45
1360	520	440	771	412	800	800	440	1120	120	22.38
1580	520	440	892	474	1000	1000	440	1340	120	26.32
1800	520	440	1013	536	1000	1000	440	1560	120	30.27

Rolo Towel

GD

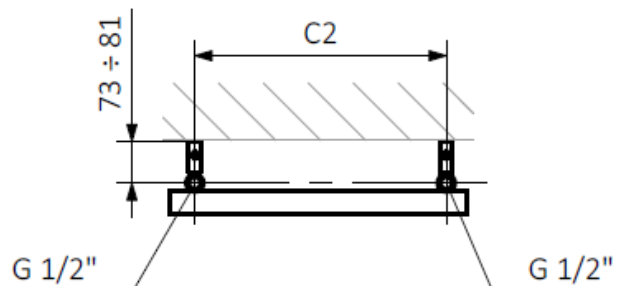
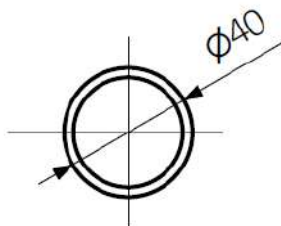
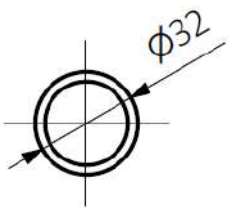
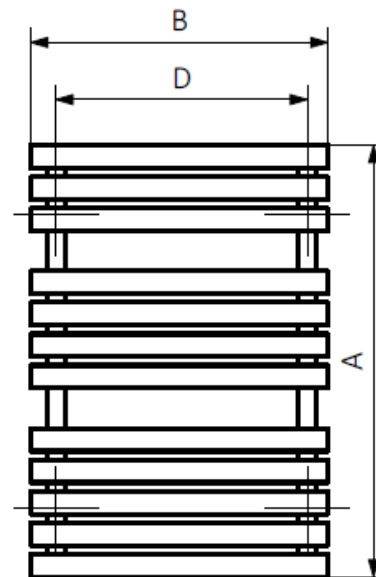
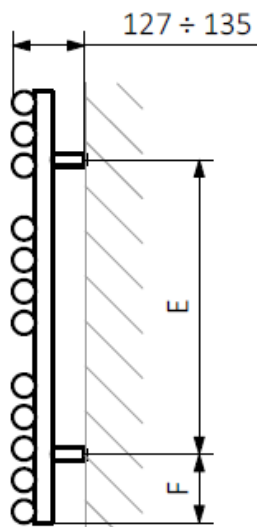
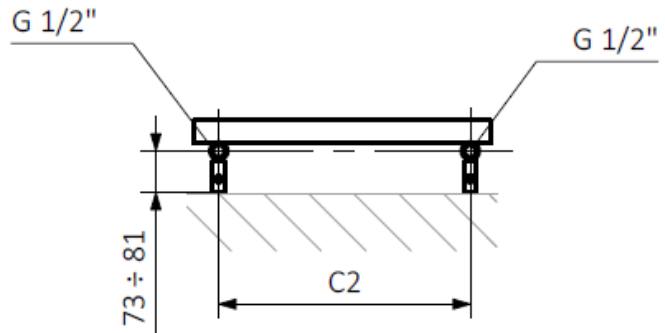

Rolo Towel

SX

