

Michelle



Michelle

Predisposizioni

Acqua calda



Elettrico



Misto



Dimensioni disponibili

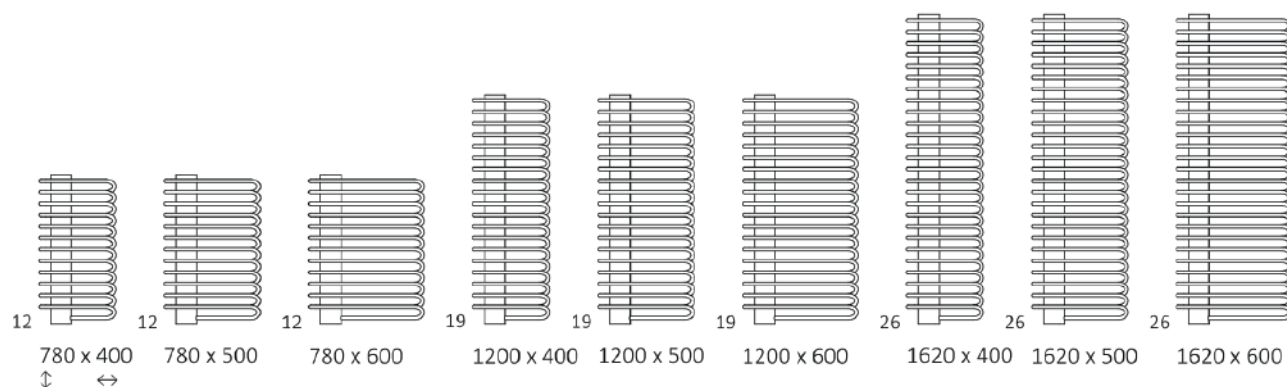



Michelle

Dati tecnici



Pressione di lavoro : 1000 KPa

Temperatura massima di lavoro : 95° C

VERNICE EPOXY

A \updownarrow [mm]	B \leftrightarrow [mm]	C1 [mm]	75/65/20°C [W]	55/45/20°C [W]	 [W]	D [mm]	E [mm]	F [mm]	 [dm³]	 [kg]
780	400	50	365	196	400	50	600	90	2,84	12,4
780	500	50	455	244	500	50	600	90	3,29	13,8
780	600	50	533	286	500	50	600	90	3,75	15,3
1200	400	50	580	310	600	50	1020	90	4,46	19,3
1200	500	50	721	386	800	50	1020	90	5,18	21,5
1200	600	50	845	452	800	50	1020	90	5,90	23,8
1620	400	50	805	429	800	50	1440	90	6,10	26,2
1620	500	50	1000	533	1000	50	1440	90	7,08	29,3
1620	600	50	1172	624	1200	50	1440	90	8,06	32,4

FINITURA CROMATA

A \updownarrow [mm]	B \leftrightarrow [mm]	C1 [mm]	75/65/20°C [W]	55/45/20°C [W]	 [W]	D [mm]	E [mm]	F [mm]	 [dm³]	 [kg]
780	400	50	256	130	300	50	600	90	2,84	12,4
780	500	50	319	162	300	50	600	90	3,29	13,8
780	600	50	373	190	400	50	600	90	3,75	15,3
1200	400	50	406	207	400	50	1020	90	4,46	19,3
1200	500	50	505	257	500	50	1020	90	5,18	21,5
1200	600	50	592	302	600	50	1020	90	5,90	23,8
1620	400	50	564	287	600	50	1440	90	6,10	26,2
1620	500	50	700	357	800	50	1440	90	7,08	29,3
1620	600	50	820	418	800	50	1440	90	8,06	32,4

Michelle

YL

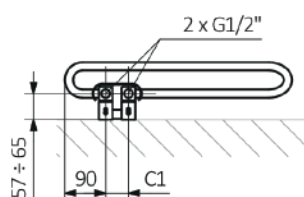

YP

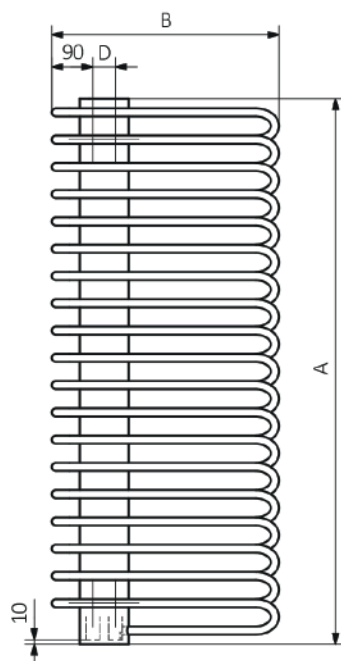
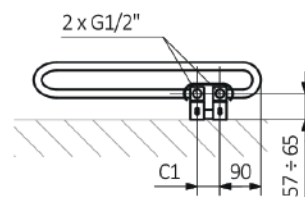

A - Altezza B - Larghezza C1-C5 - Distanza tra connessioni D - Distanza orizzontale tra gli elementi di fissaggio
 E - Distanza verticale tra gli elementi di fissaggio F - Distanza dall'asse centrale inferiore degli elementi di fissaggio
 al bordo inferiore del collettore

Collettore :

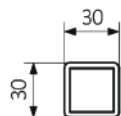

Tubo :



Michelle

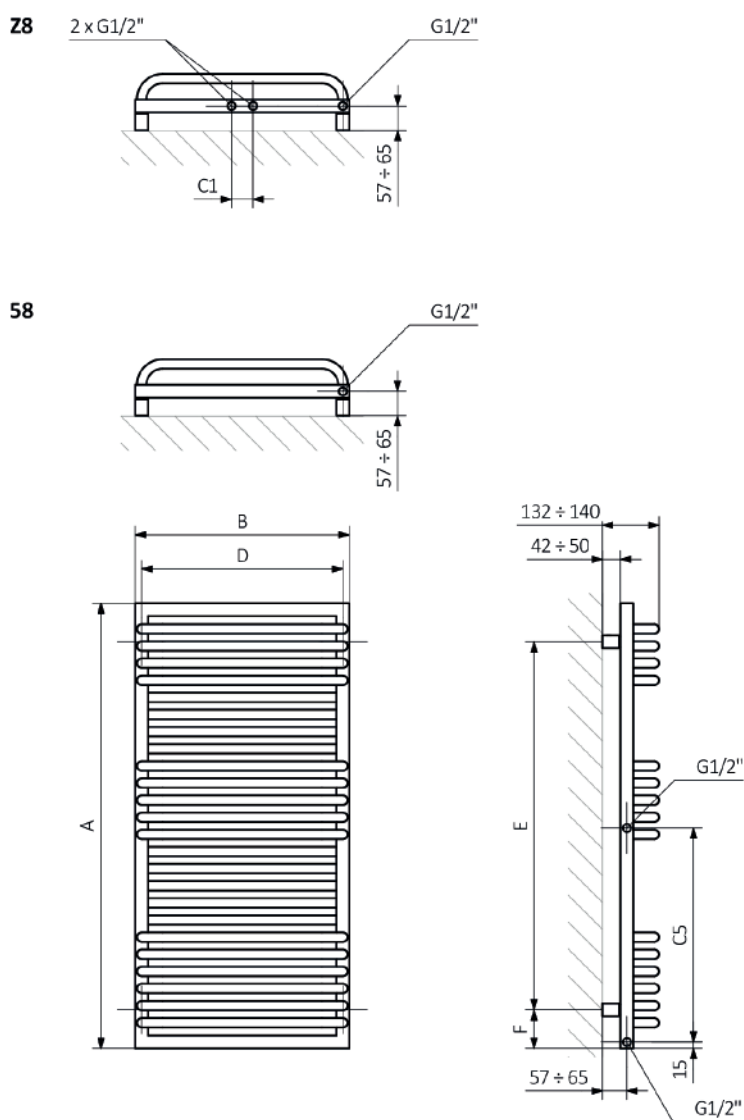

A - Altezza B - Larghezza C1-C5 - Distanza tra connessioni D - Distanza orizzontale tra gli elementi di fissaggio E - Distanza verticale tra gli elementi di fissaggio F - Distanza dall'asse centrale inferiore degli elementi di fissaggio al bordo inferiore del collettore

Collettore:

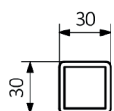

Profilo:

