

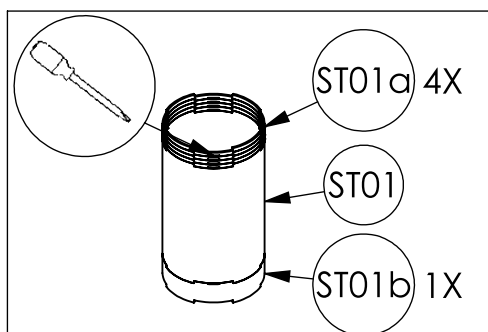

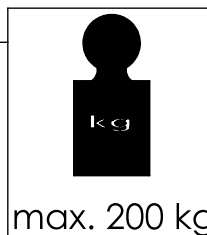

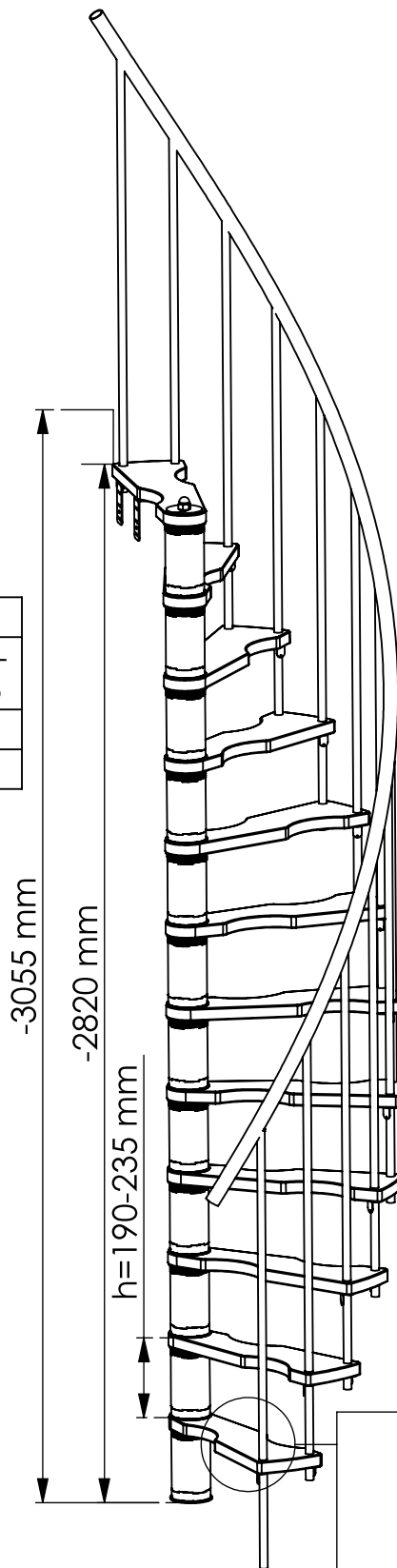

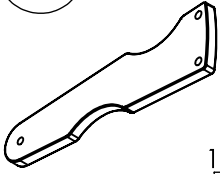

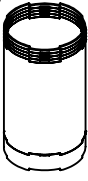
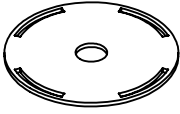

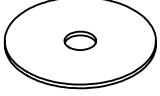
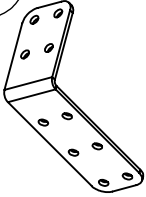

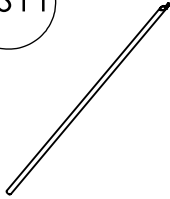
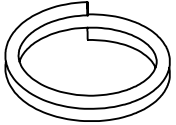
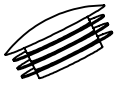
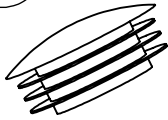
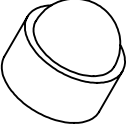
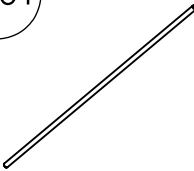

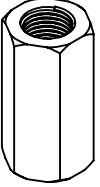

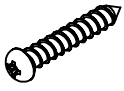

| | | | | | |
|---|-----------|-----------|-----------|-----------|-----------|
| | 5 | 4 | 3 | 2 | 1 |
| H | 1710-2115 | 1900-2350 | 2090-2585 | 2280-2820 | 2470-3055 |
| A | 112° | 126° | 140° | 154° | 168° |
| B | 96° | 108° | 120° | 132° | 144° |

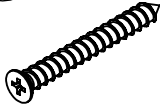

| h | ST01a | ST01b |
|--------|-------|-------|
| 190 mm | 0x | 0x |
| 195 mm | 1x | 0x |
| 200 mm | 2x | 0x |
| 205 mm | 3x | 0x |
| 210 mm | 4x | 0x |
| 215 mm | 0x | 1x |
| 220 mm | 1x | 1x |
| 225 mm | 2x | 1x |
| 230 mm | 3x | 1x |
| 235 mm | 4x | 1x |

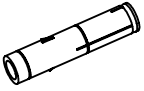
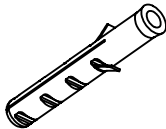

| | | | | |
|---|--|---|---|--|
| <p>HS10 a..120 b..140</p>  <p>12x</p> | <p>ST01</p>  <p>12x</p> <p>∅ 108x200 mm</p> | <p>ST02</p>  <p>23x</p> | <p>ST03</p>  <p>1x</p> | <p>ST06u</p>  <p>1x</p> <p>∅ 100 x 3 mm</p> |
| <p>ST09</p>  <p>2x</p> | <p>ST11</p>  <p>24x</p> | <p>ST14</p>  <p>1x</p> | <p>GS11</p>  <p>13x</p> <p>∅ 22x2x1260 mm</p> | <p>G01</p>  <p>1x</p> <p>∅ 40x3x6000mm</p> |
| <p>KS01</p>  <p>12x</p> <p>∅ 22 mm</p> | <p>KS02</p>  <p>2x</p> <p>∅ 40 mm</p> | <p>KS04</p>  <p>1x</p> <p>M20</p> | <p>NT01</p>  <p>3x</p> <p>M20x1000 mm</p> | <p>NT02</p>  <p>6x</p> <p>M20 DIN 934</p> |
| <p>NT04</p>  <p>2x</p> <p>M20 DIN 6334</p> | <p>NT05</p>  <p>4x</p> <p>M8x50 mm</p> | <p>NT06</p>  <p>48x</p> <p>∅ 5 x 30 mm</p> | <p>NT07</p>  <p>24x</p> <p>4,2 x 19mm</p> | <p>NT08</p>  <p>1x</p> <p>∅ 4 x 50 mm</p> |
| <p>NT09</p>  <p>8x</p> <p>6 x 30mm</p> | <p>NT10</p>  <p>12x</p> <p>6 x 50mm</p> | <p>NT11</p>  <p>26x</p> <p>∅ 4x25mm</p> | <p>NT30</p>  <p>1x</p> <p>M5 x 6 mm</p> | <p>NT31</p>  <p>1x</p> <p>M5 DIN 562</p> |
| <p>D01</p>  <p>4x</p> <p>∅ 12 mm</p> | <p>D02</p>  <p>12x</p> <p>∅ 8mm</p> | <p>D03</p>  <p>1x</p> <p>∅ 6mm</p> | | |

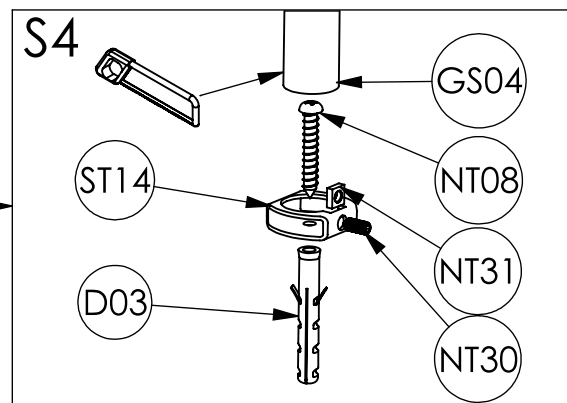
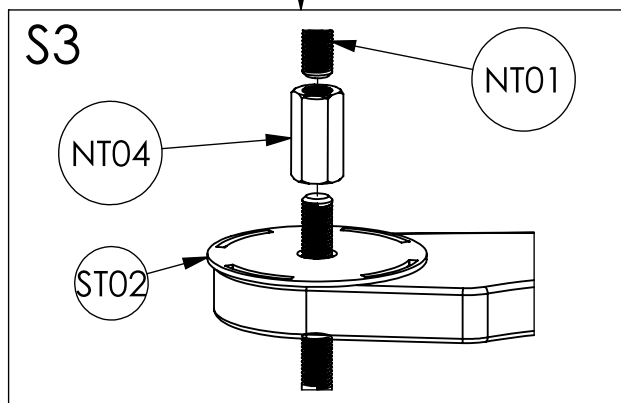
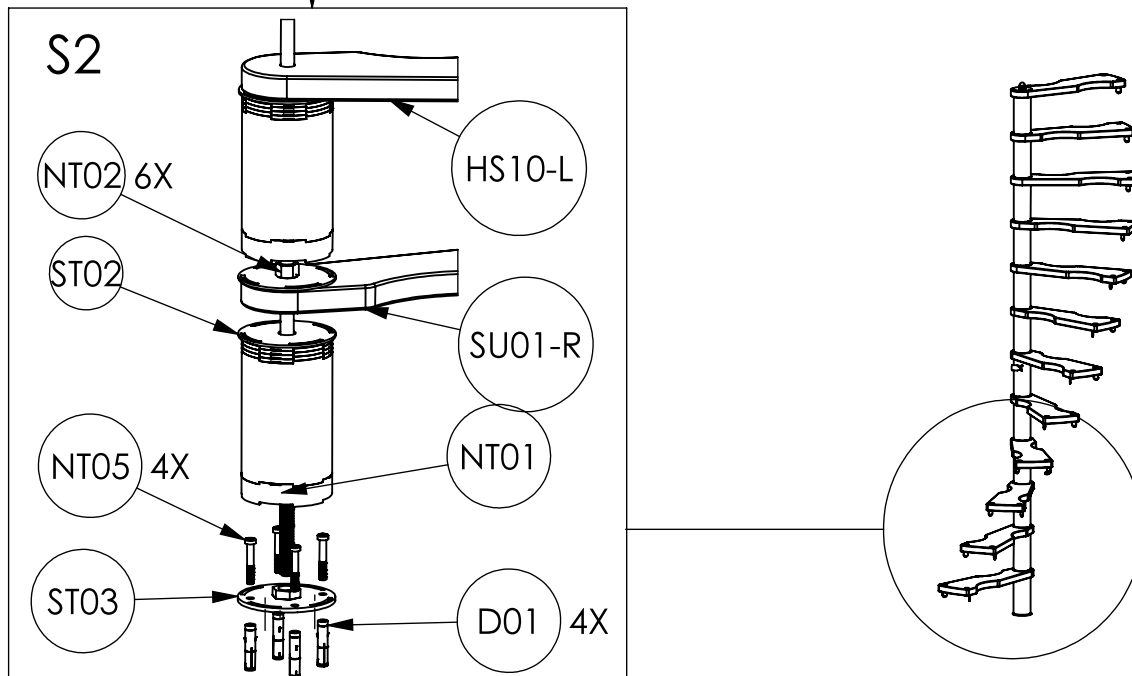
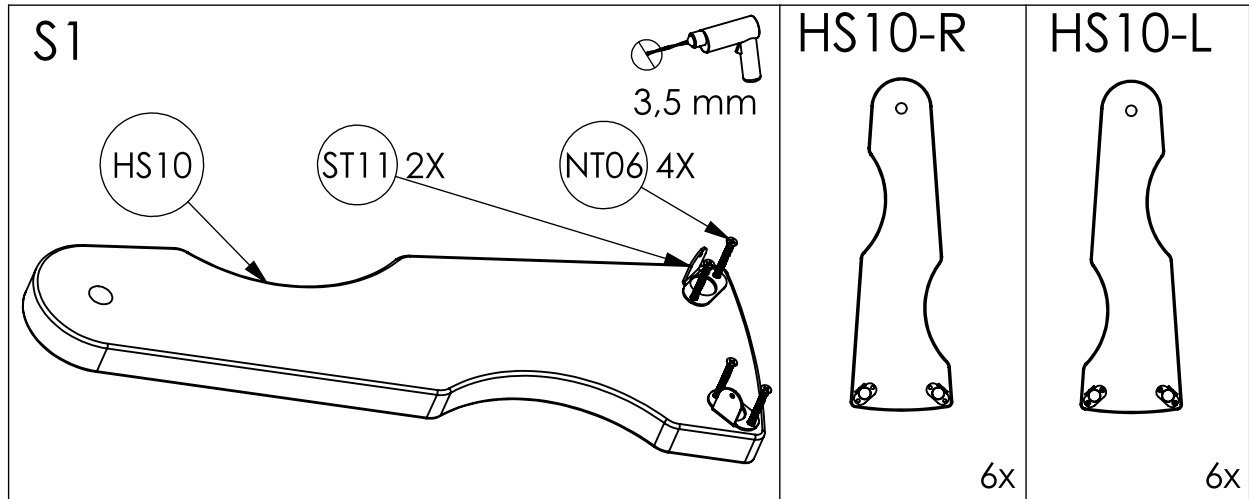

3

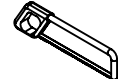
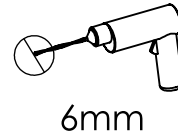
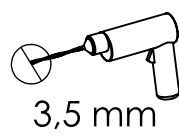
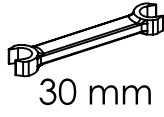
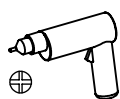
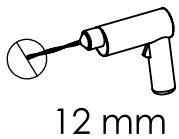

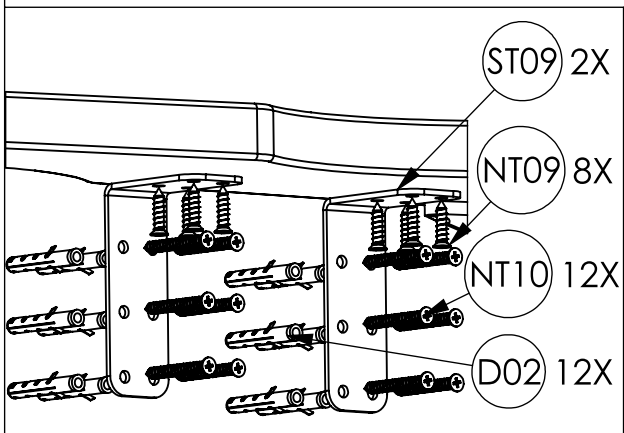
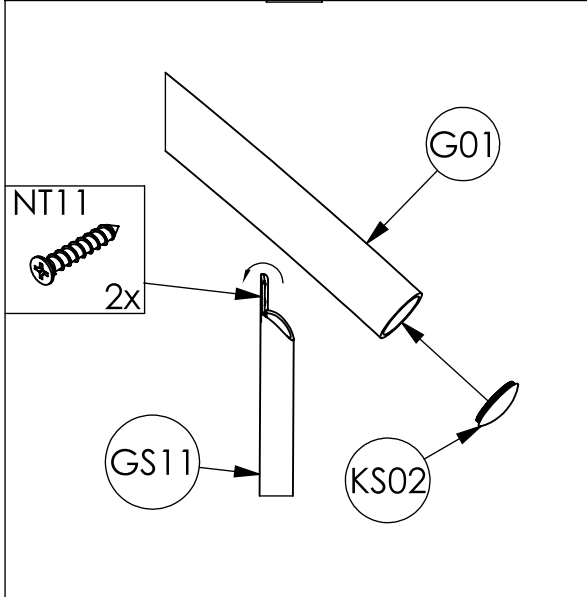
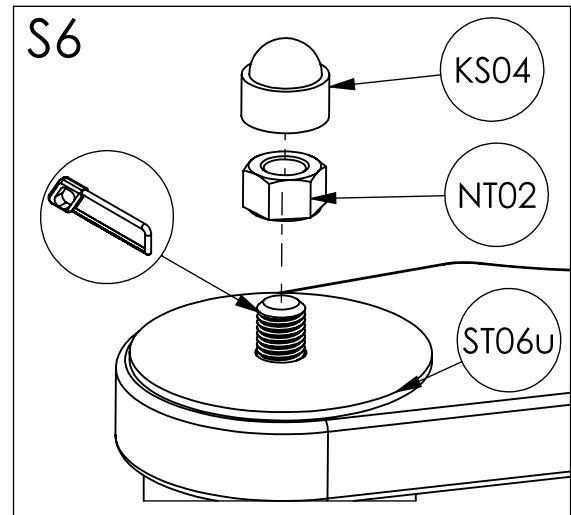
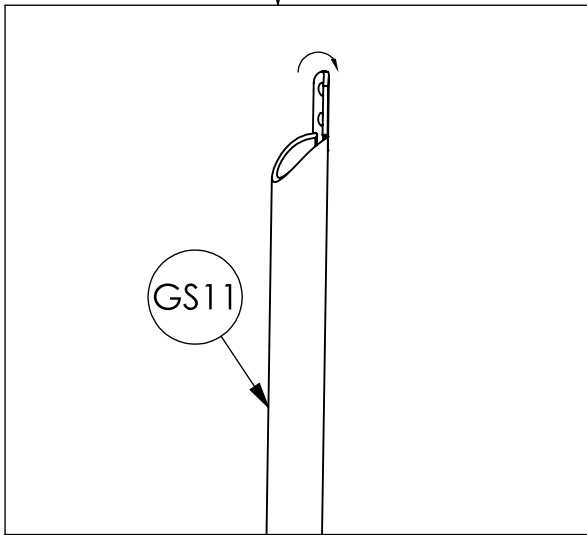
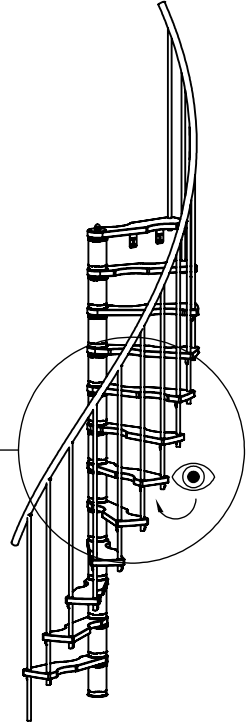
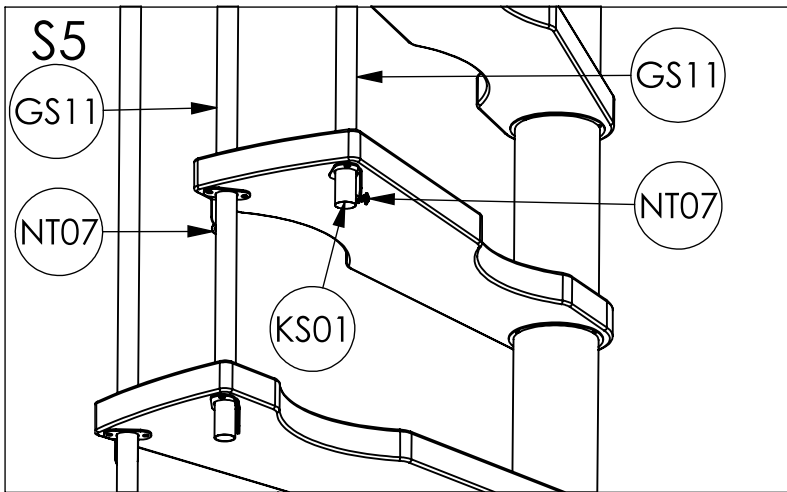

4

