

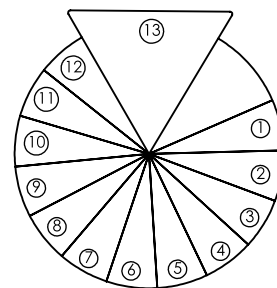

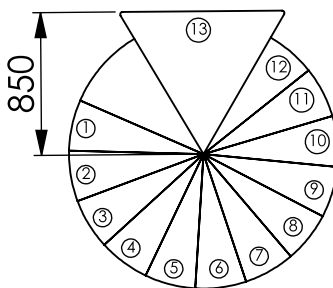

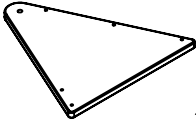

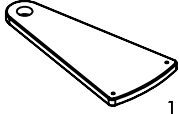

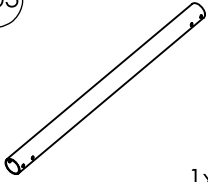

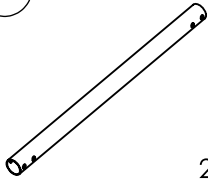
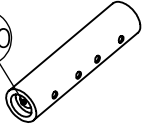
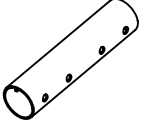
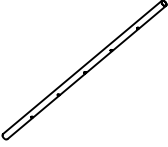
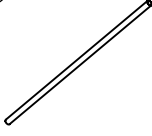
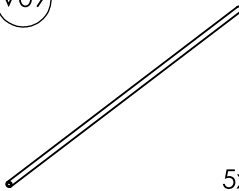
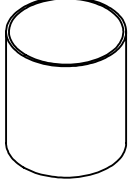
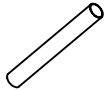

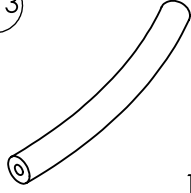
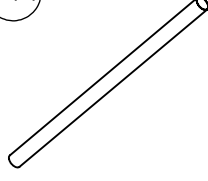
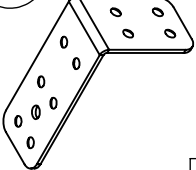
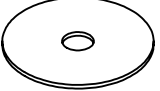
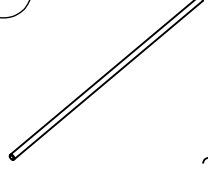

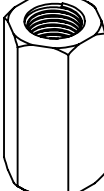

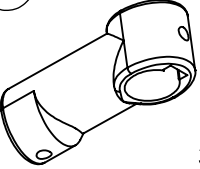
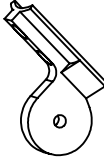







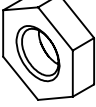
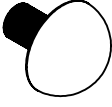

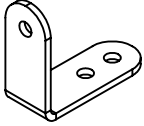

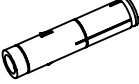
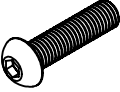
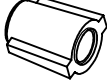
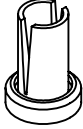
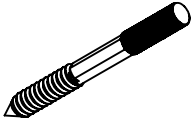

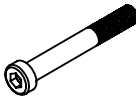

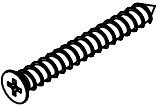

DM T60

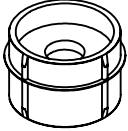

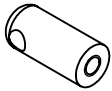
| | | | | |
|--|--|---|--|---|
| <p>V01</p>  <p>1x</p> | <p>V02</p>  <p>12x</p> | <p>V03</p>  <p>1x</p> <p>Ø 50 x 910x1 mm</p> | <p>V04a</p>  <p>1x</p> <p>Ø 51 x 100 mm</p> | <p>V05</p>  <p>2x</p> <p>Ø 60,2 x 980 mm</p> |
| <p>V06</p>  <p>M20</p> <p>1x</p> <p>Ø 51x2,6x220 mm</p> | <p>V07</p>  <p>1x</p> <p>Ø 51x2,6x220 mm</p> | <p>V08</p>  <p>16x</p> <p>Ø 22x1x840 mm</p> | <p>V08a</p>  <p>1x</p> <p>Ø 22x1x840 mm</p> | <p>V09</p>  <p>5x</p> <p>Ø 6x1x6000 mm</p> |
| <p>V10</p>  <p>13x</p> <p>Ø 127x179 mm</p> | <p>V11</p>  <p>14x</p> <p>Ø 22x1x175 mm</p> | <p>V12</p>  <p>1x</p> <p>Ø 22x1x70 mm</p> | <p>V13</p>  <p>12x</p> <p>Ø 40 mm</p> | <p>V14</p>  <p>1x</p> <p>Ø 40x950 mm</p> |
| <p>V15a</p>  <p>2x</p> | <p>V16</p>  <p>1x</p> <p>Ø 100 x 3 mm</p> | <p>V17</p>  <p>2x</p> <p>M20 x 1000 mm</p> | <p>V19</p>  <p>11x</p> <p>Ø 15x50 mm</p> | <p>V20</p>  <p>13x</p> <p>M10 x 120 mm</p> |
| <p>V21</p>  <p>1x</p> <p>M20 DIN 6334</p> | <p>V22</p>  <p>104x</p> <p>Ø 127 x 3 mm</p> | <p>V23</p>  <p>3x</p> | <p>V24</p>  <p>16x</p> | <p>V25</p>  <p>2x</p> <p>Ø 50 mm</p> |
| <p>V26</p>  <p>16x</p> | <p>V27a</p>  <p>12x</p> <p>Ø 8 mm</p> | <p>V27b</p>  <p>2x</p> <p>Ø 12 mm</p> | <p>V28</p>  <p>1x</p> <p>Ø 22 mm</p> | <p>V29</p>  <p>1x</p> <p>Ø 35 mm</p> |

| | | | | |
|--|---|---|---|---|
| <p>V30</p>  <p>M20 DIN 934</p> <p>1x</p> | <p>V30a</p>  <p>M20 DIN 439B</p> <p>1x</p> | <p>V31</p>  <p>Ø 40 mm</p> <p>4x</p> | <p>V32</p>  <p>M5 DIN 934</p> <p>16x</p> | <p>V33</p>  <p>37x28x12 mm</p> <p>1x</p> |
| <p>V34</p>  <p>M6 DIN 562</p> <p>6x</p> | <p>V35</p>  <p>M8 x 55 mm</p> <p>4x</p> | <p>V36</p>  <p>M10 x 70 mm</p> <p>16x</p> | <p>V37</p>  <p>M10</p> <p>44x</p> | <p>V38</p>  <p>44x</p> |
| <p>V39</p>  <p>M10 x 100 mm</p> <p>2x</p> | <p>V40a</p>  <p>M8 x 50 mm</p> <p>4x</p> | <p>V41</p>  <p>M8x55mm DIN6912</p> <p>8x</p> | <p>V42</p>  <p>M5 x 20 mm DIN7991</p> <p>16x</p> | <p>V43</p>  <p>M6 x 6 mm DIN 914</p> <p>6x</p> |
| <p>V44</p>  <p>Ø 6 x 50 mm</p> <p>12x</p> | <p>V45</p>  <p>Ø 6 x 30 mm</p> <p>8x</p> | <p>V46</p>  <p>Ø 3,9 x 19 mm</p> <p>2x</p> | <p>V47</p>  <p>Ø 30 x 3 mm</p> <p>84x</p> | <p>V49</p>  <p>8x</p> |
| <p>V50</p>  <p>Ø 3,5 x 25 mm</p> <p>59x</p> | <p>V51</p>  <p>80x</p> | <p>V52</p>  <p>M6 x 14 mm</p> <p>80x</p> | <p>V53</p>  <p>Ø 8 x 12 mm</p> <p>20x</p> | <p>V54</p>  <p>Ø 4 x 25 mm</p> <p>16x</p> |

| h | |
|-------|----------|
| 0xV47 | = 220 mm |
| 1xV47 | = 223 mm |
| 2xV47 | = 226 mm |
| 3xV47 | = 229 mm |
| 4xV47 | = 232 mm |
| 5xV47 | = 235 mm |
| 6xV47 | = 238 mm |

| h | |
|-------|----------|
| 2xV22 | = 220 mm |
| 3xV22 | = 223 mm |
| 4xV22 | = 226 mm |
| 5xV22 | = 229 mm |
| 6xV22 | = 232 mm |
| 7xV22 | = 235 mm |
| 8xV22 | = 238 mm |

12 mm 6 mm 13 mm

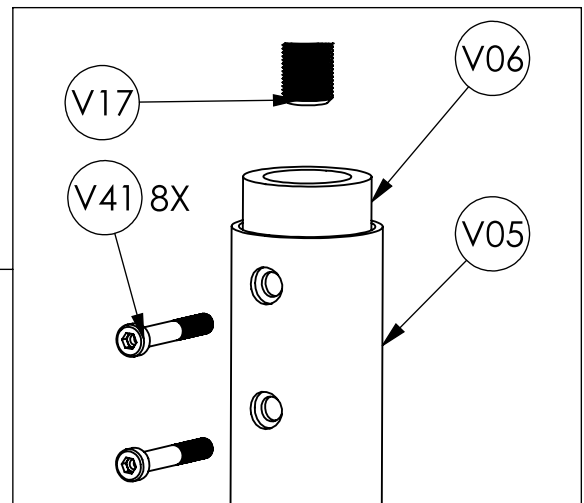
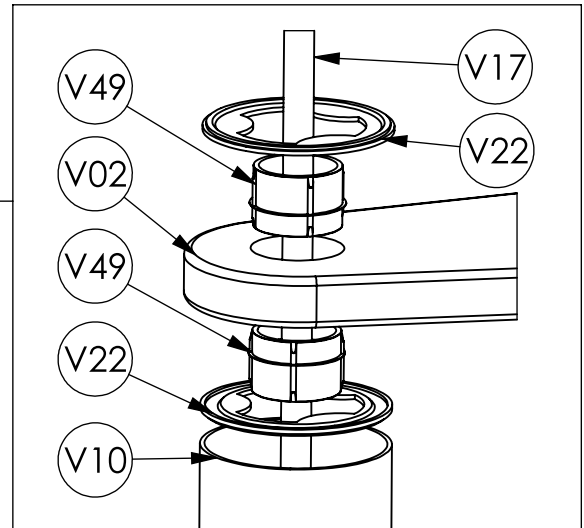
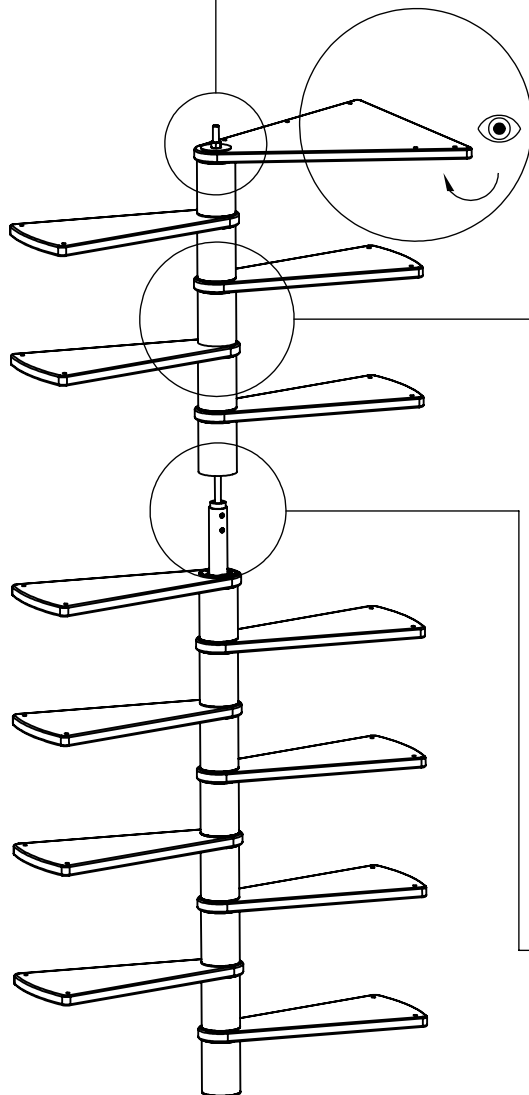
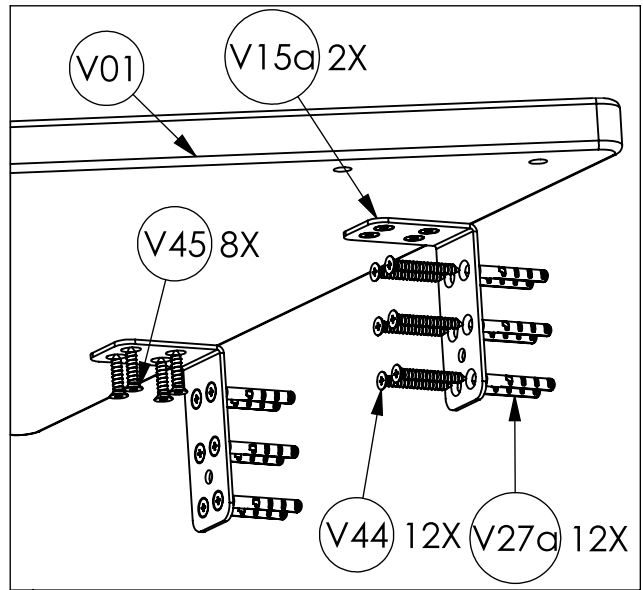
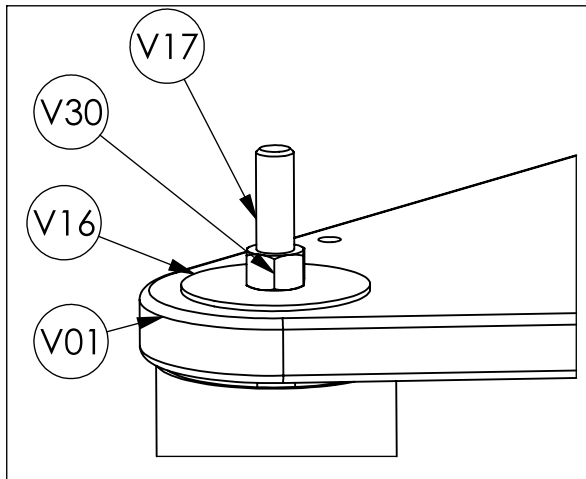

5

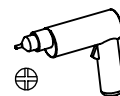
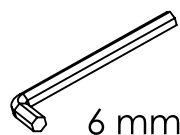
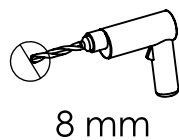
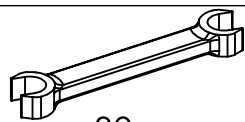

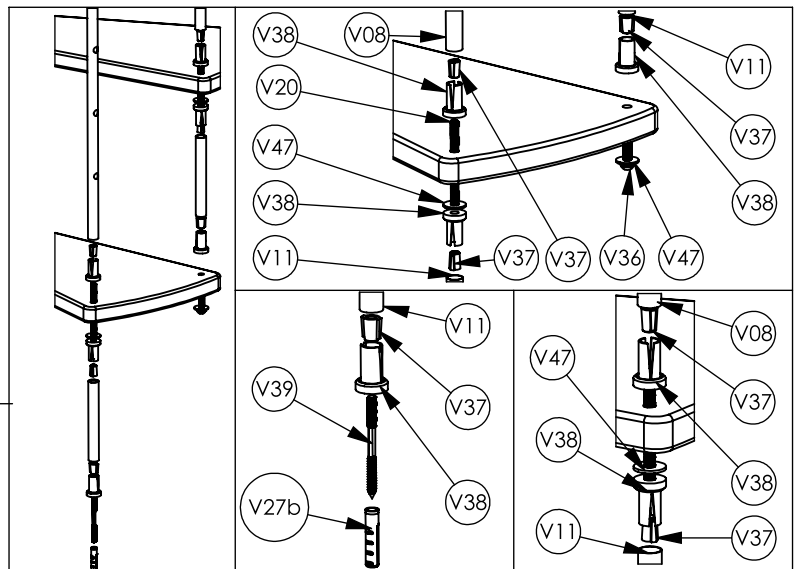
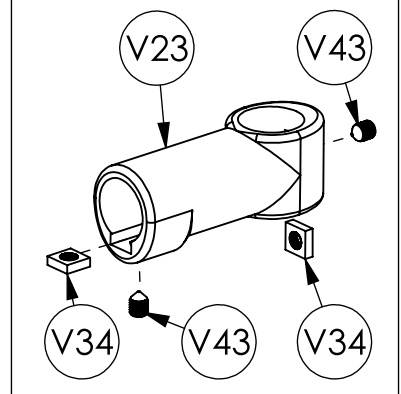
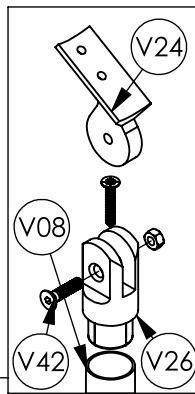
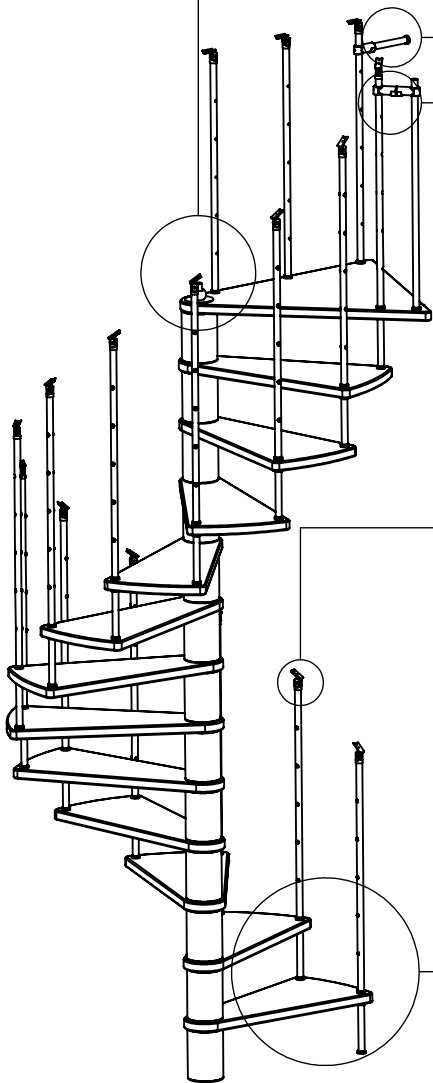
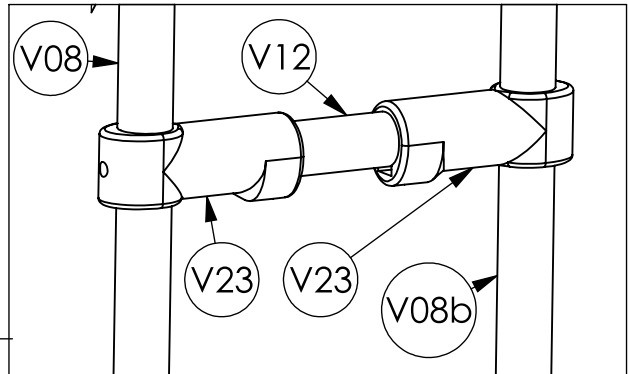
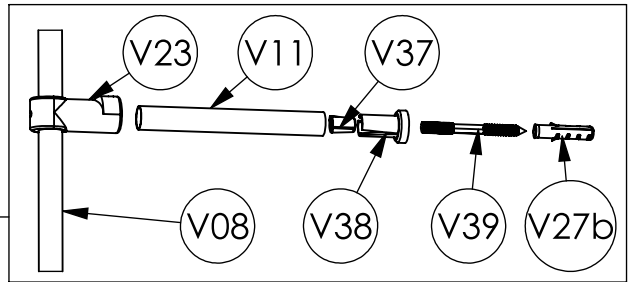
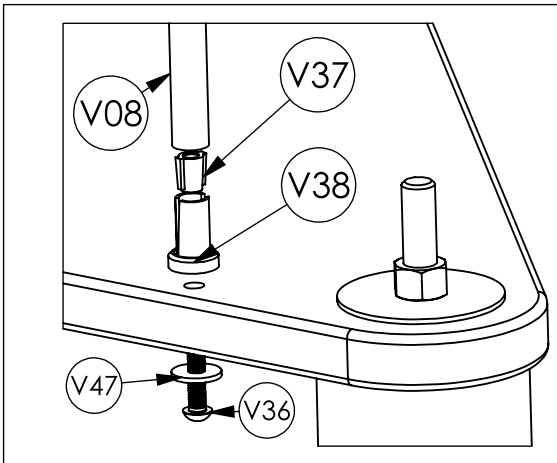

6

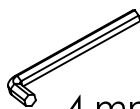

4 mm



3 mm

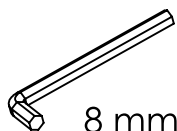

8 mm

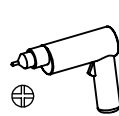

12 mm

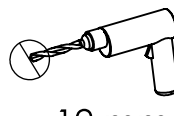

8 mm

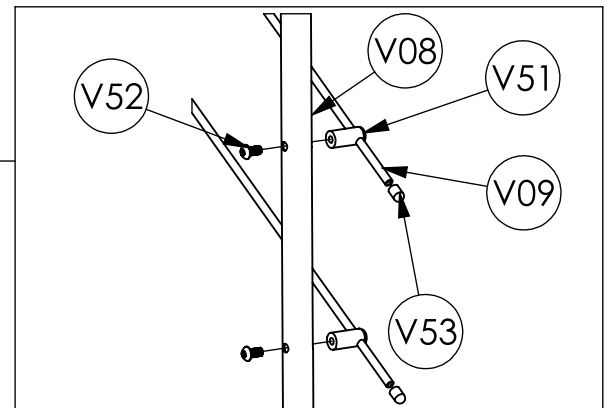
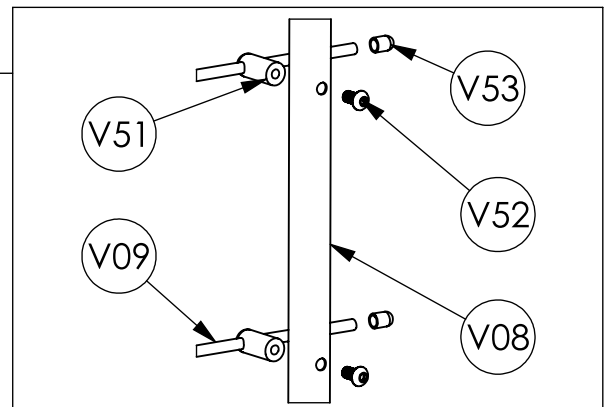
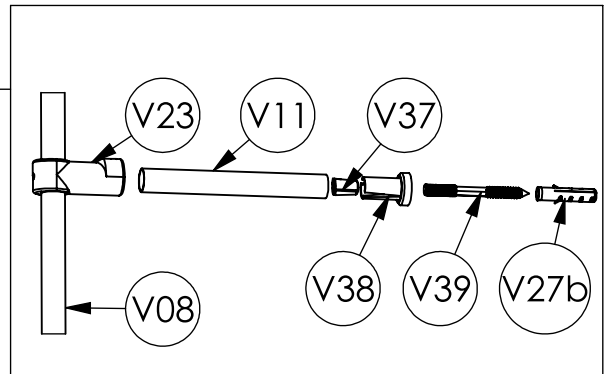
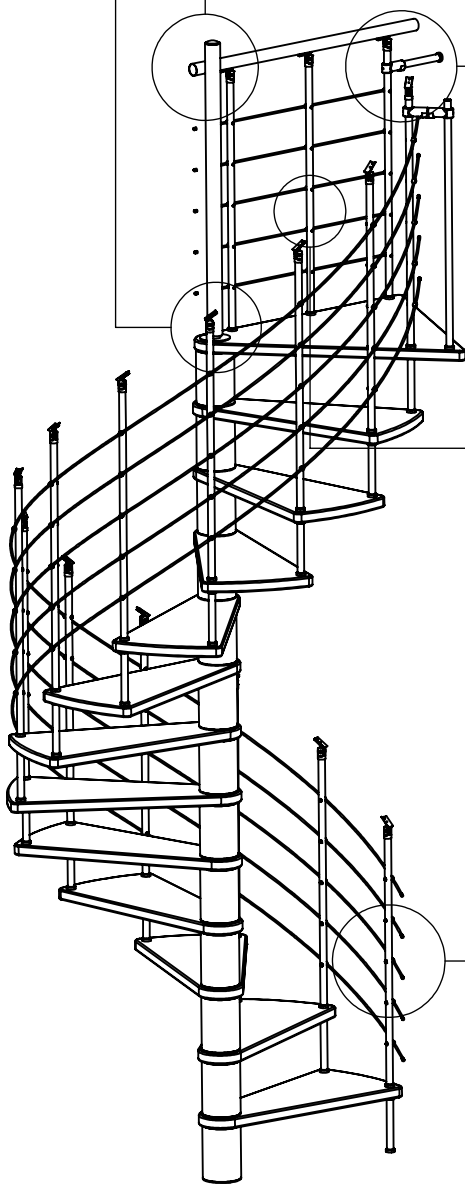
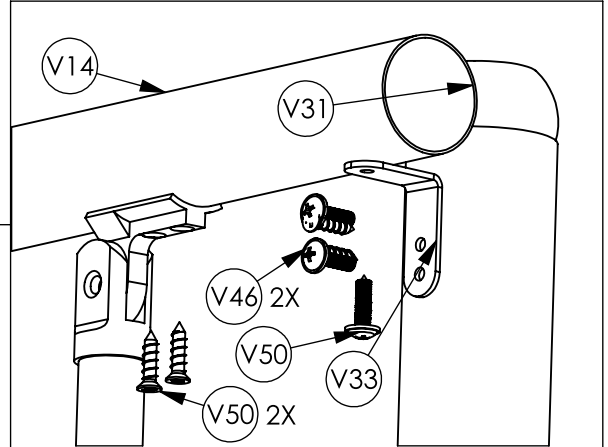
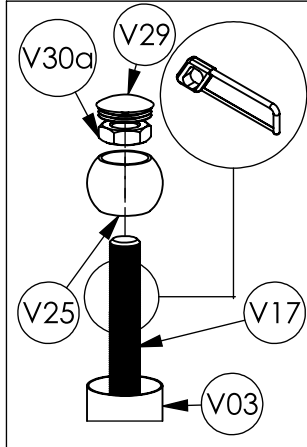
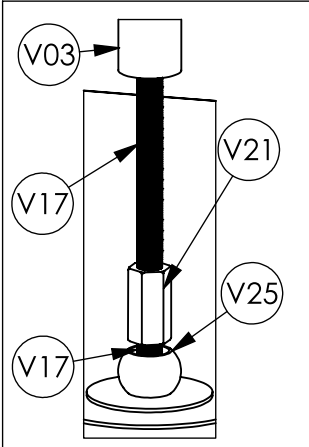

7

