

A

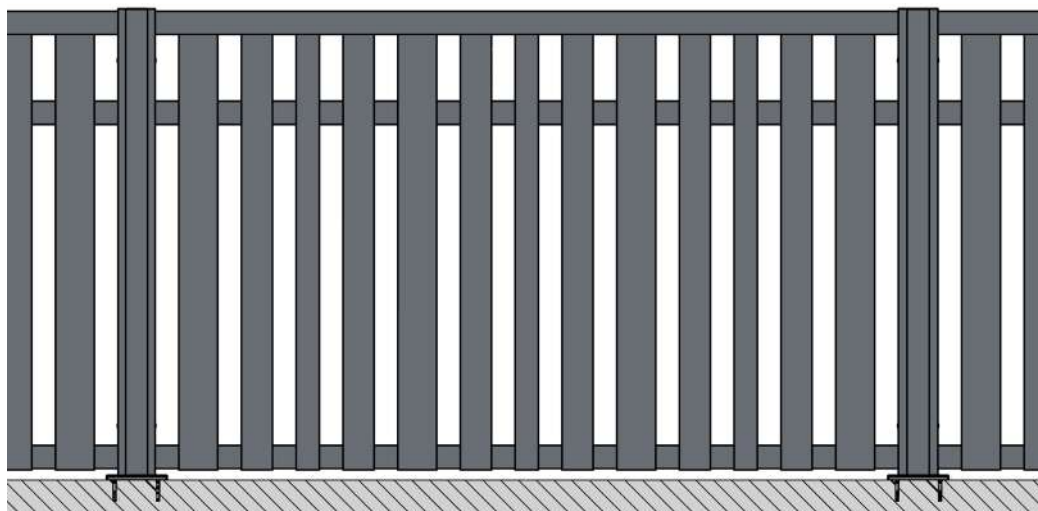

B

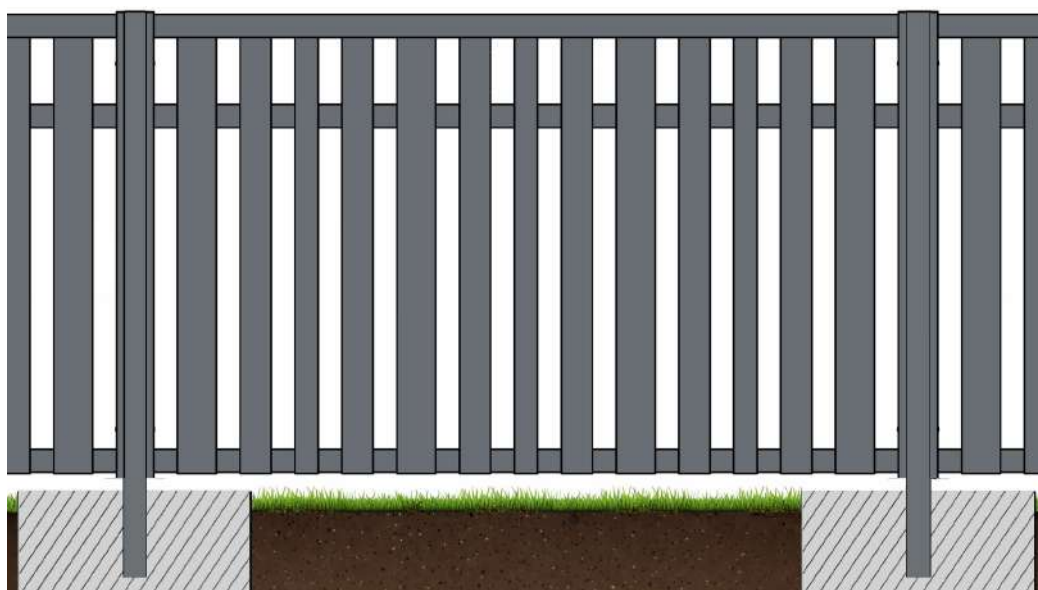

C

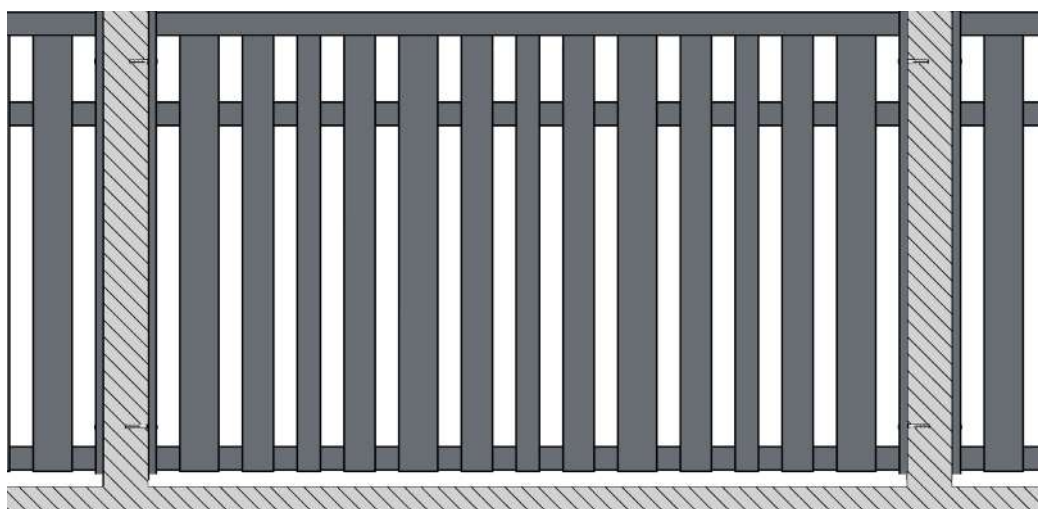

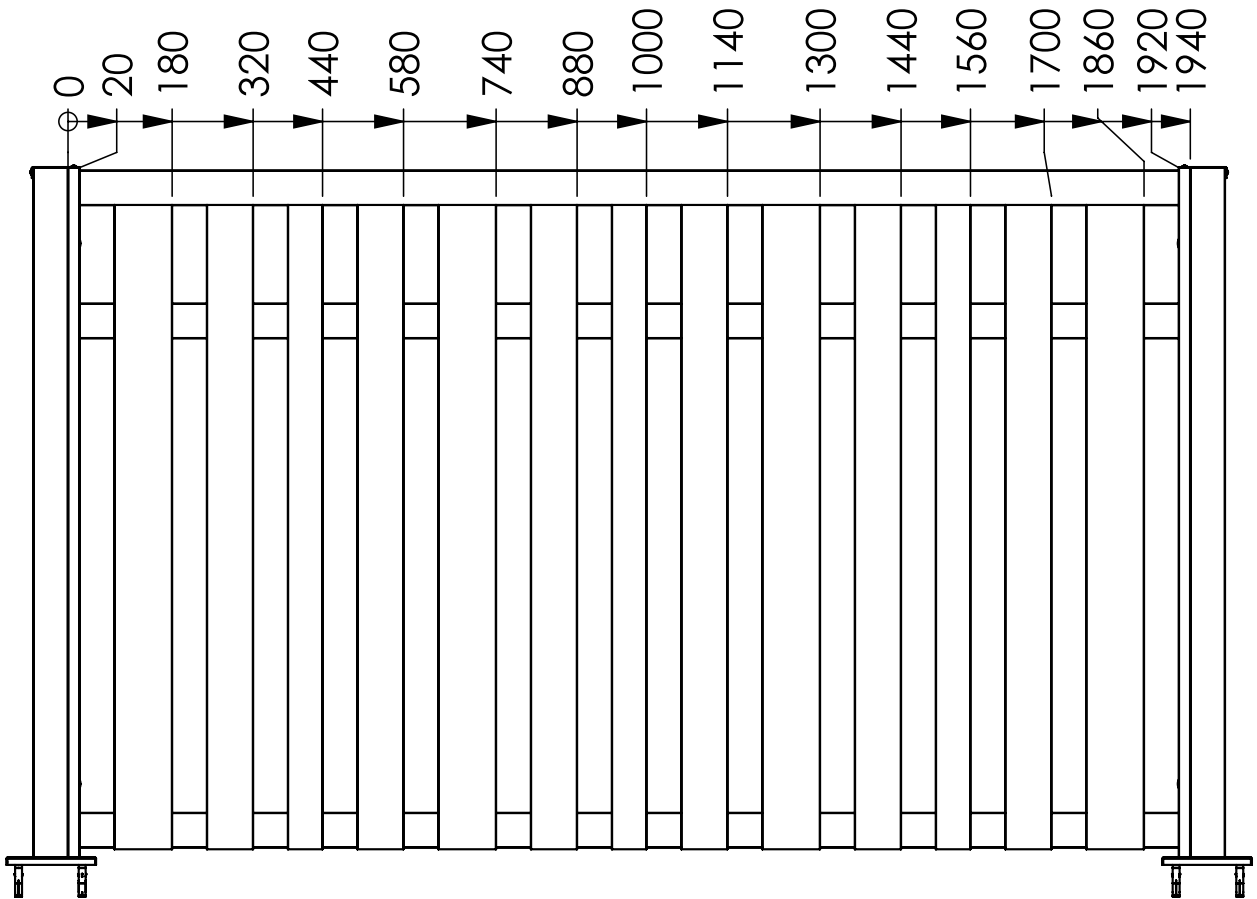
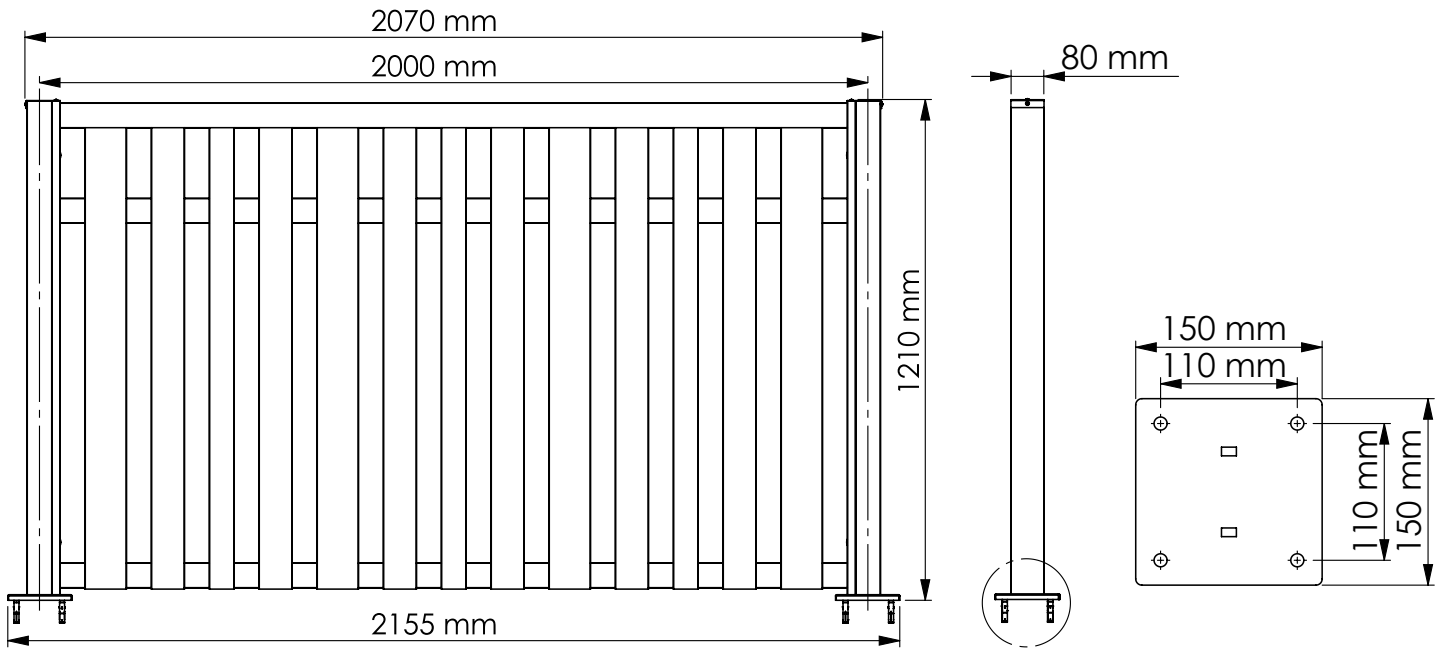

8x

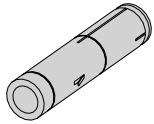

D01 M8x55 mm

4x

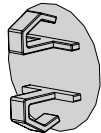

KS09 Ø13 mm

8x

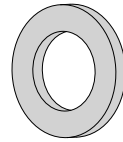

NT26 M8 DIN125A

12x

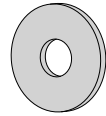

NT39 M5 DIN9021

8x

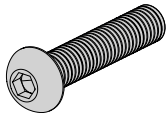

NT47 M8x60 mm  
ISO7380-1

6x



NT77 Ø3,5x16mm

26x

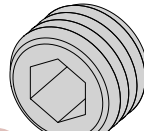

NT78 M6x6mm

4x

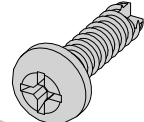

NT79 Ø5,5x22 mm

2x

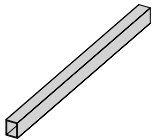

ZT01 80x60x1200 mm

2x

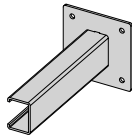

ZT02

2x

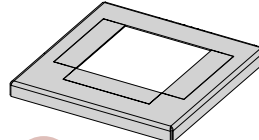

ZT03

2x

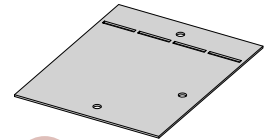

ZT04

2x

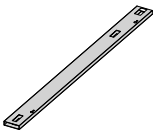

ZT06 80x20x1200 mm

1x



ZT07 60x30x1940 mm

2x



ZT08 60x20x1940 mm

3x

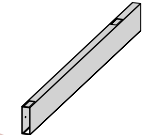

ZT13 60x30x1113,5 mm

6x

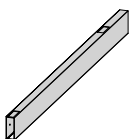

ZT14 80x30x1113,5  
mm

4x

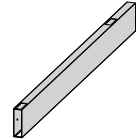

ZT15 100x30x1113,5  
mm

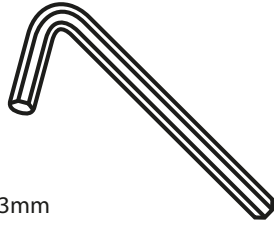
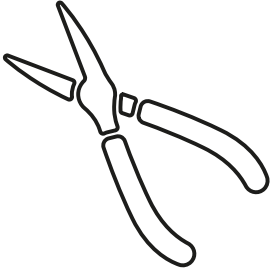

3mm  
5mm

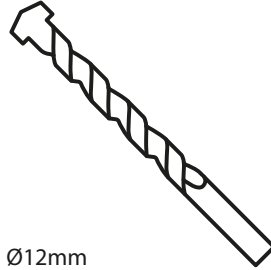

Ø12mm

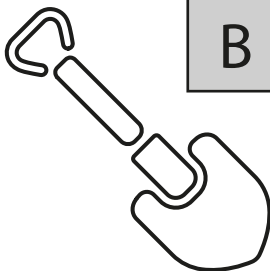
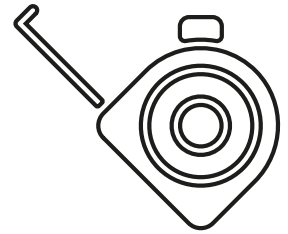
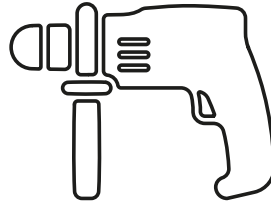
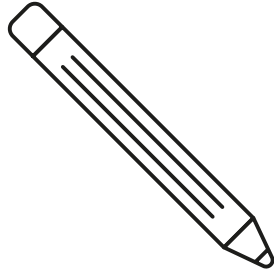
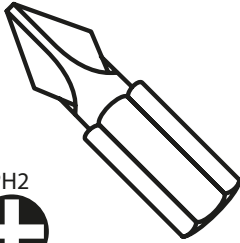
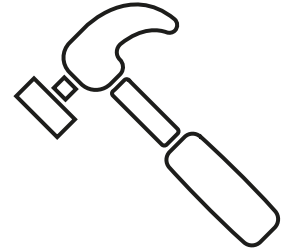

B

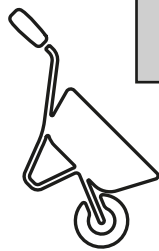

B

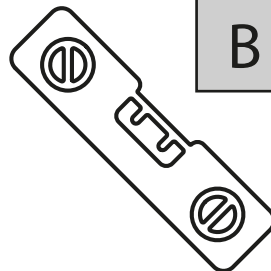

B

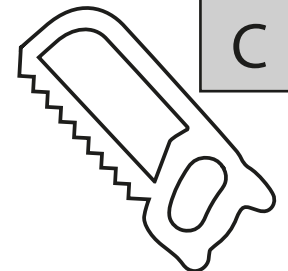

C

4x

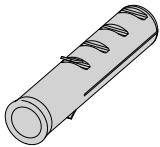

C

4x



min. Ø5x60 mm

C

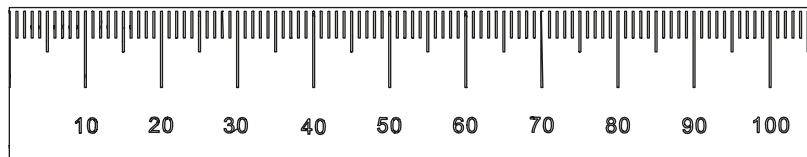

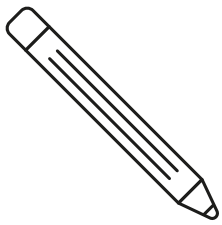

5mm

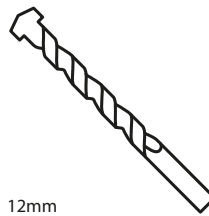
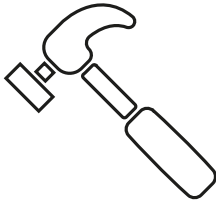

12mm

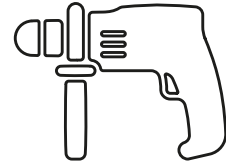

1

A

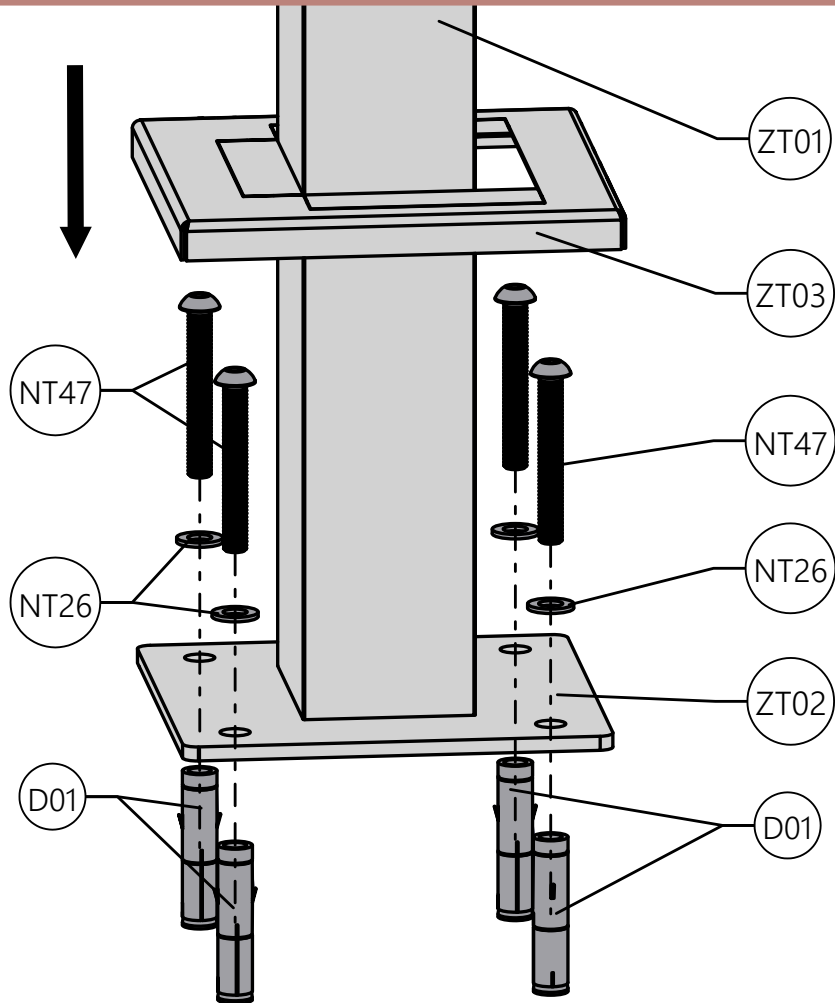
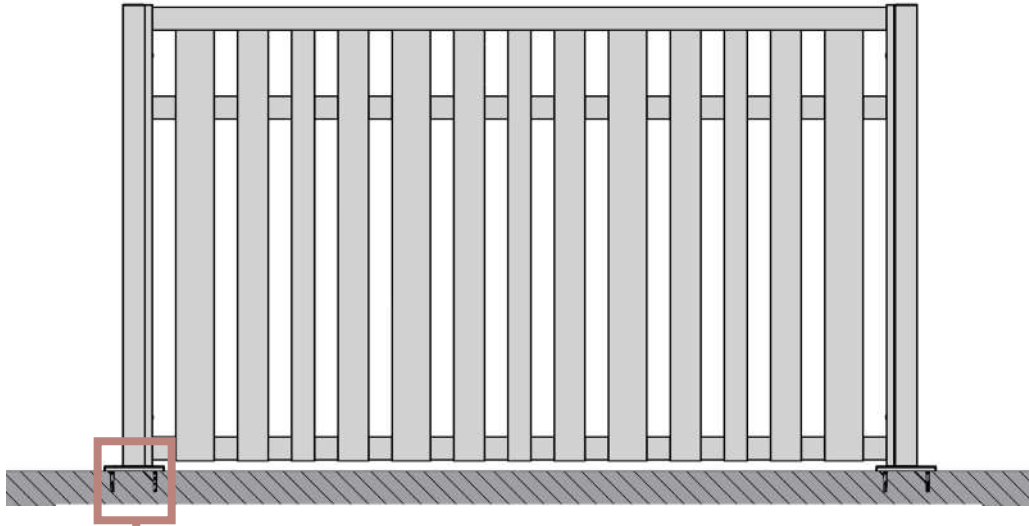

2

B

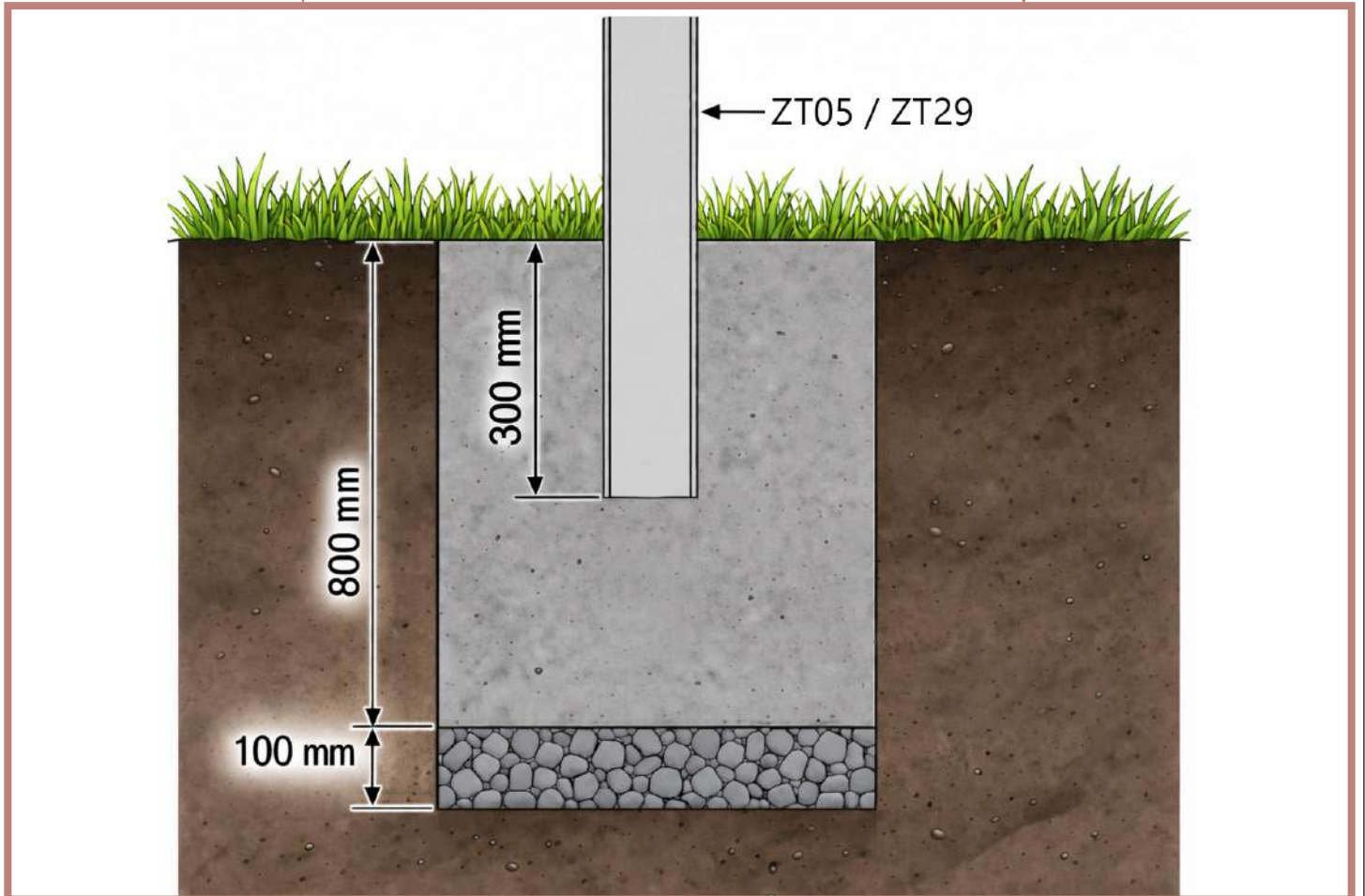
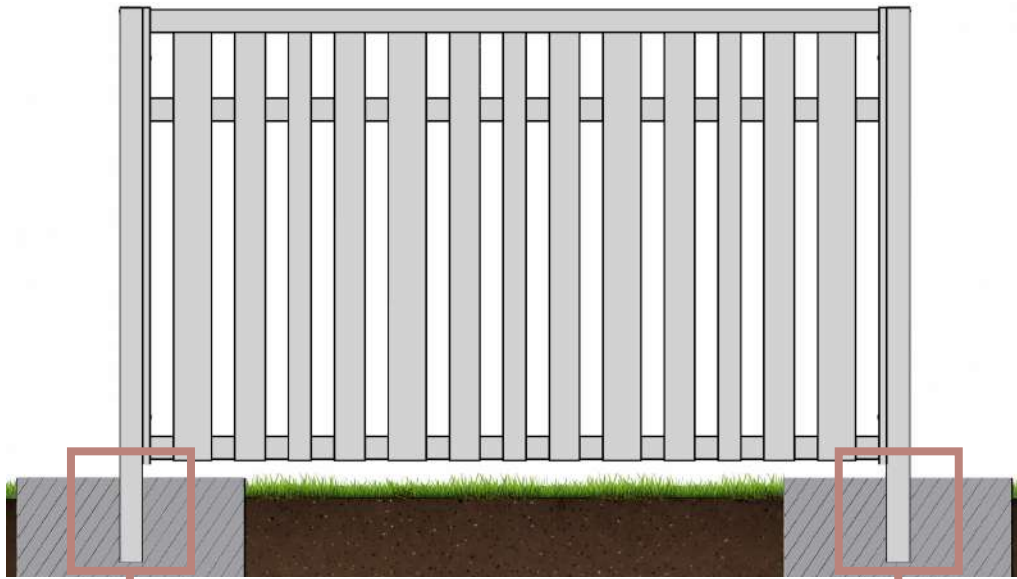
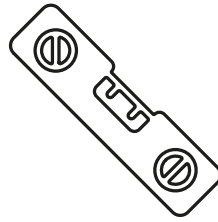
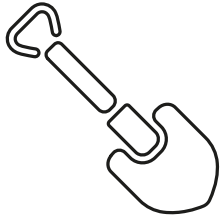

3

C

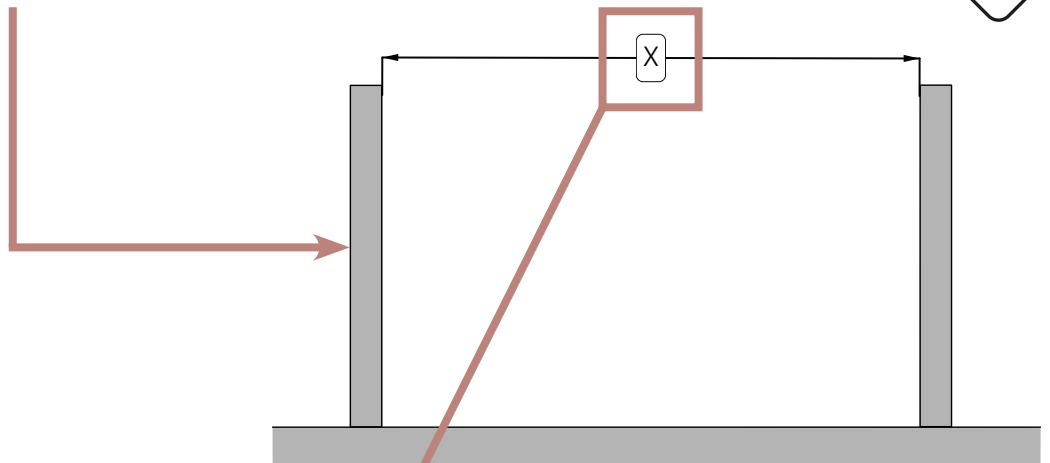
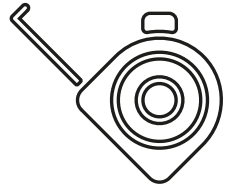
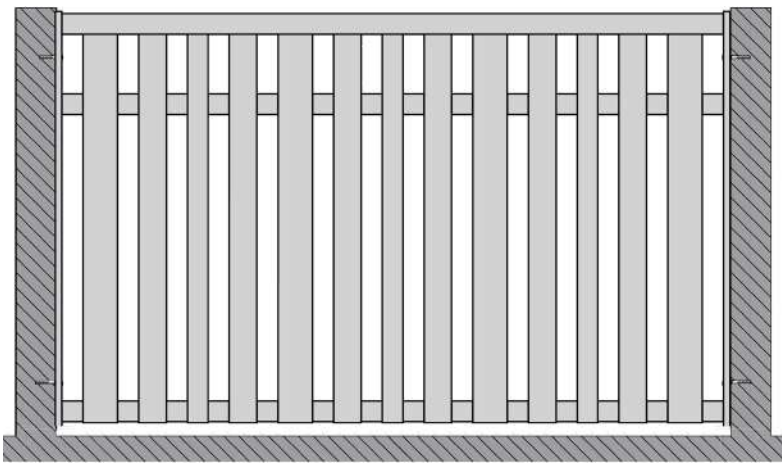

ZT07

ZT08

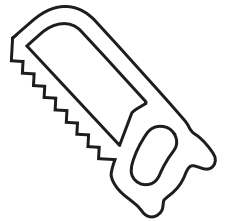
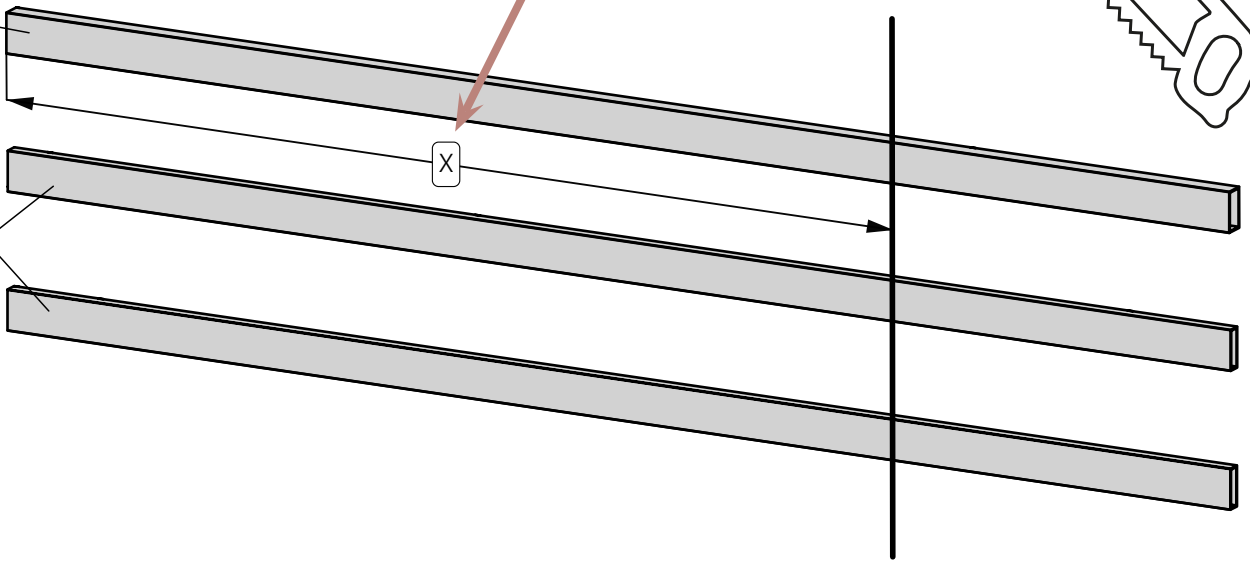

4

A

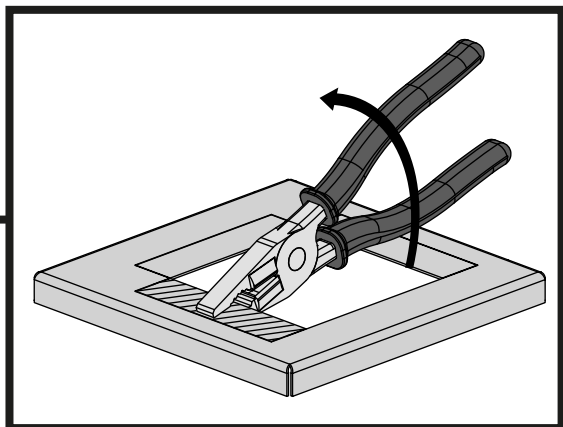
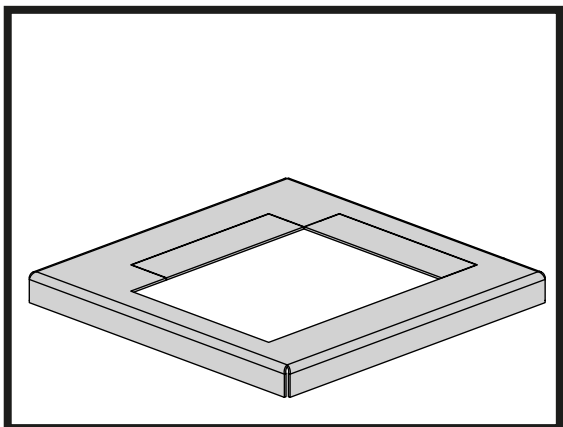
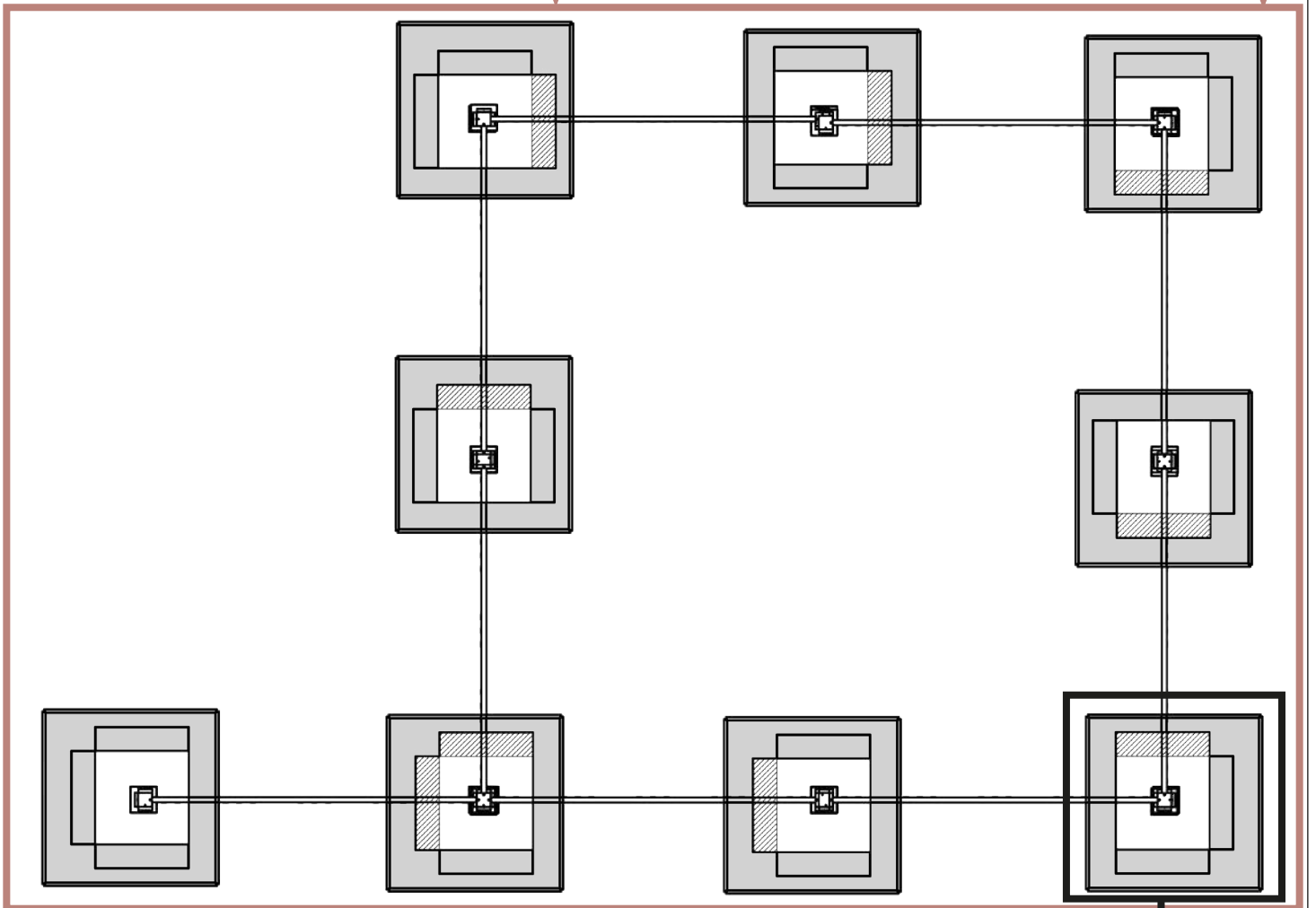
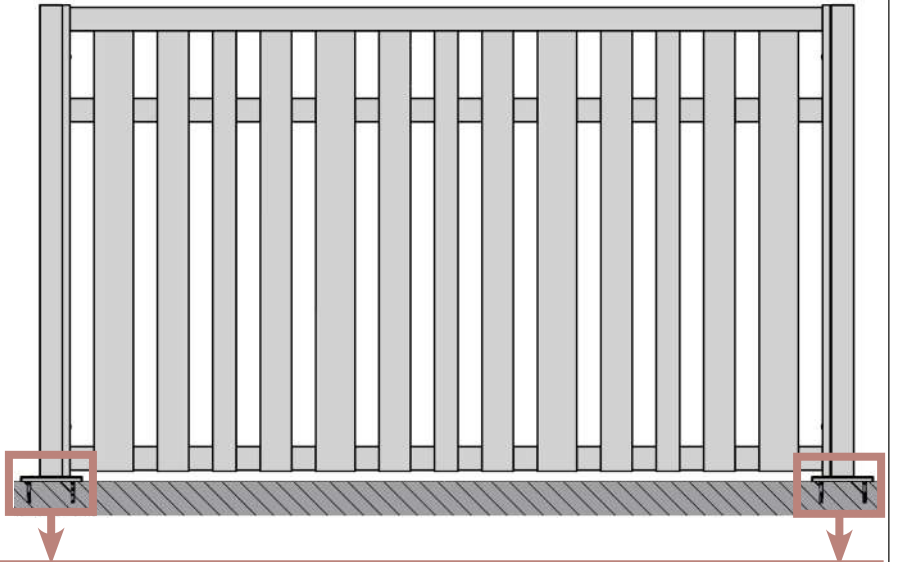
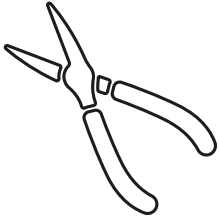

5

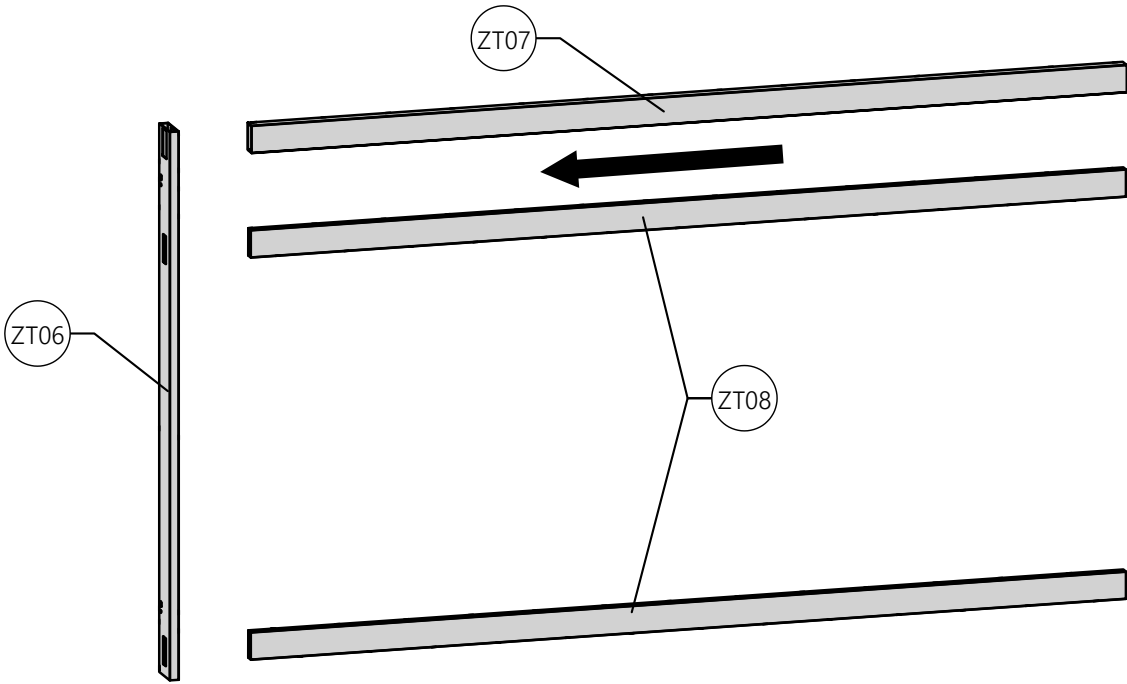

A

B

C

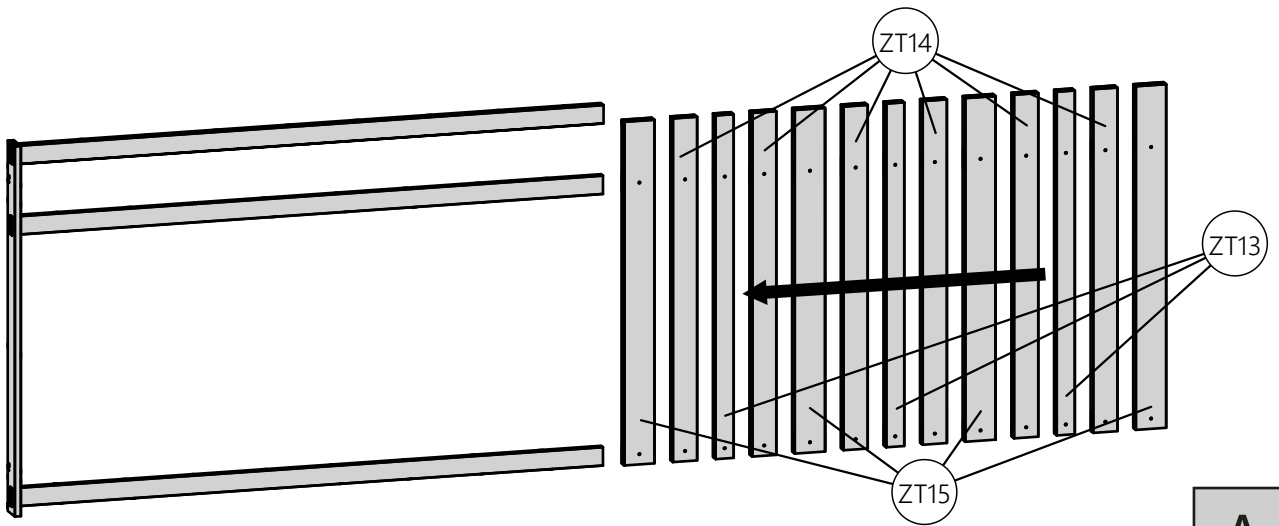

A

B

C

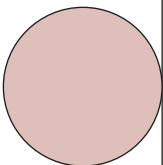

7

A

B

C

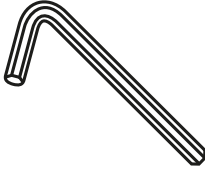

3mm

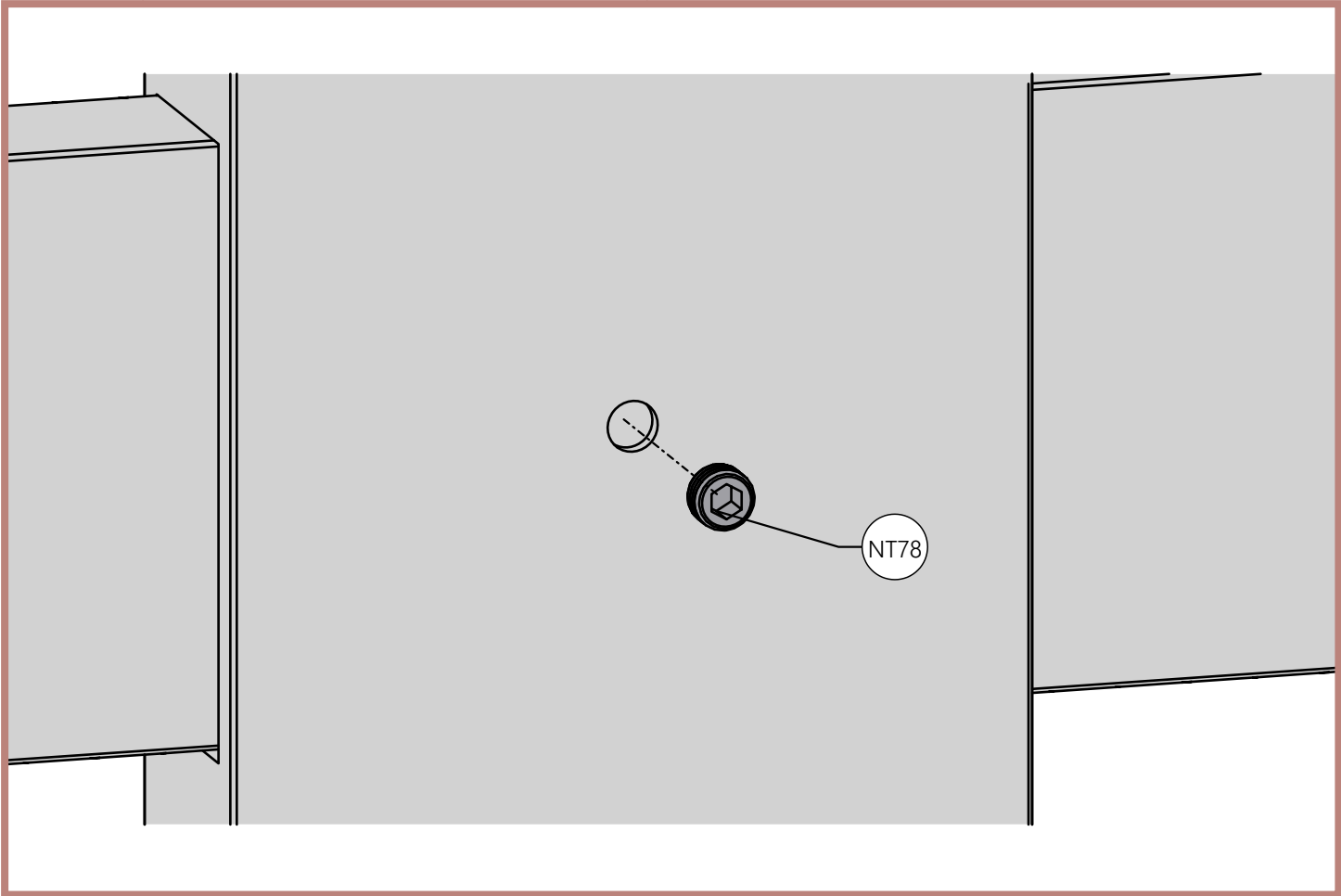
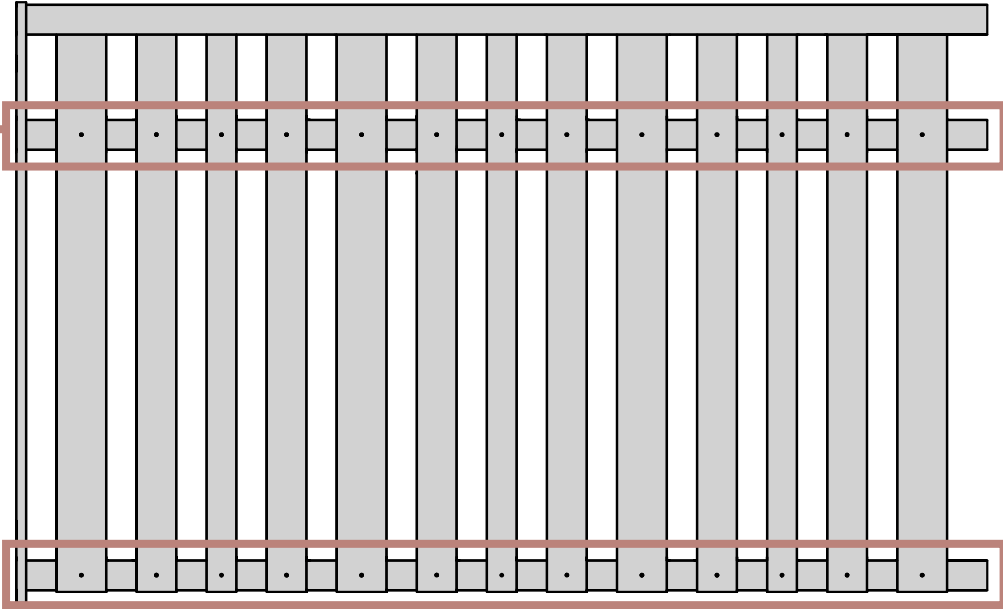

8

A

B

C

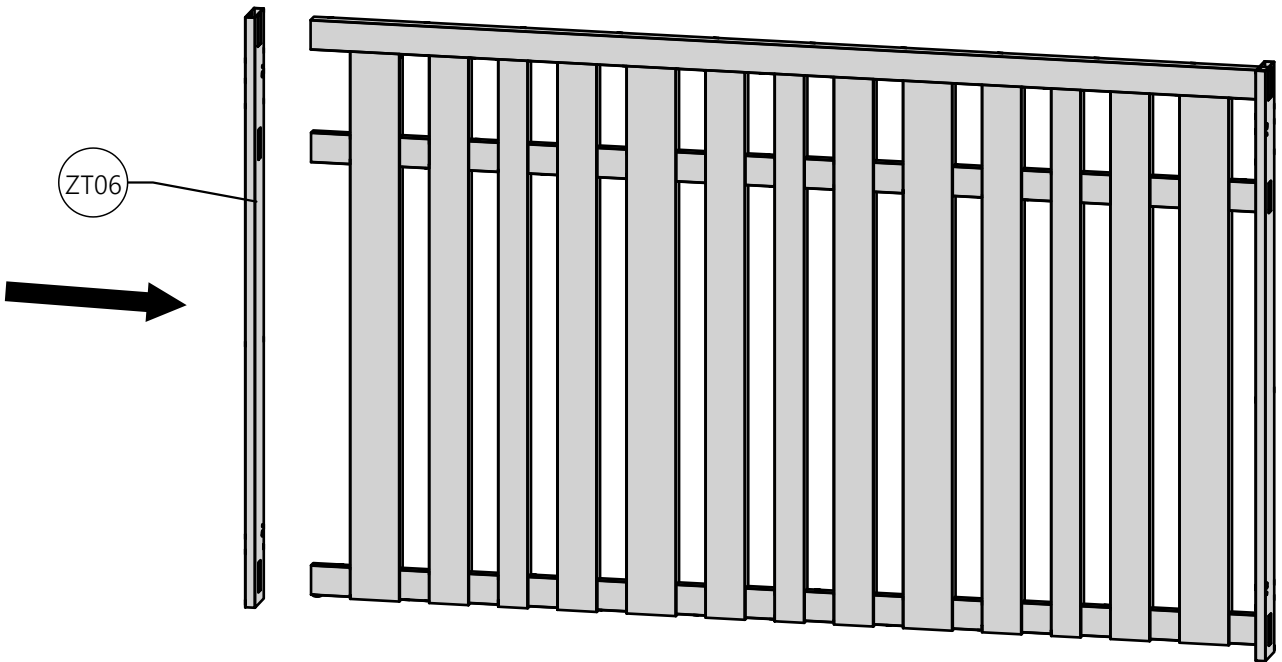
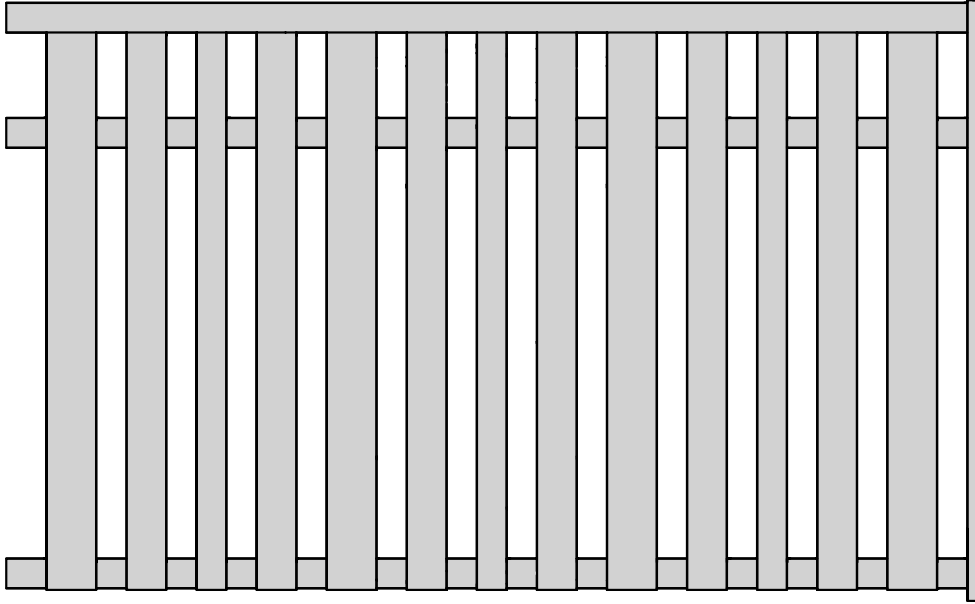

9

A

B

C

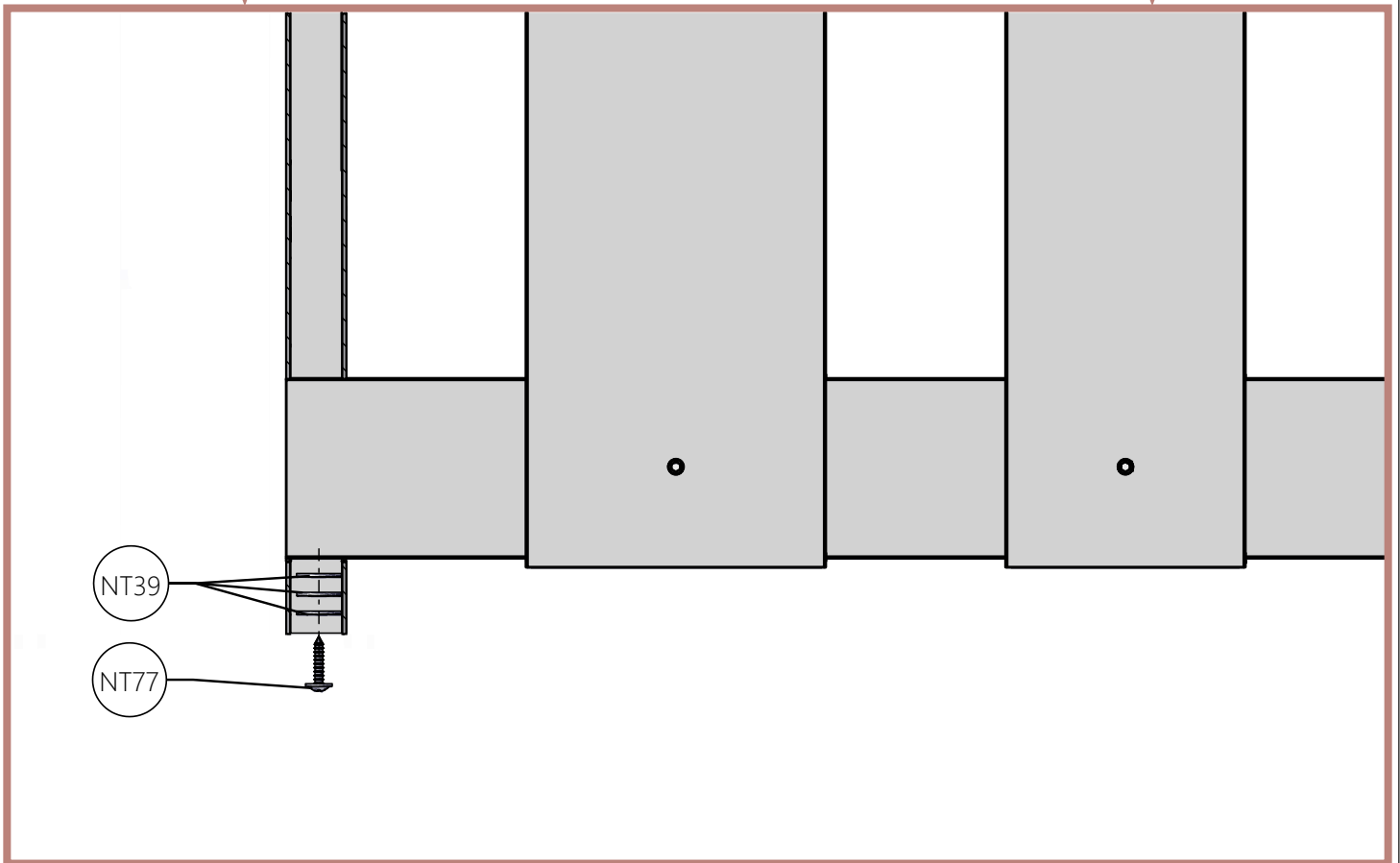
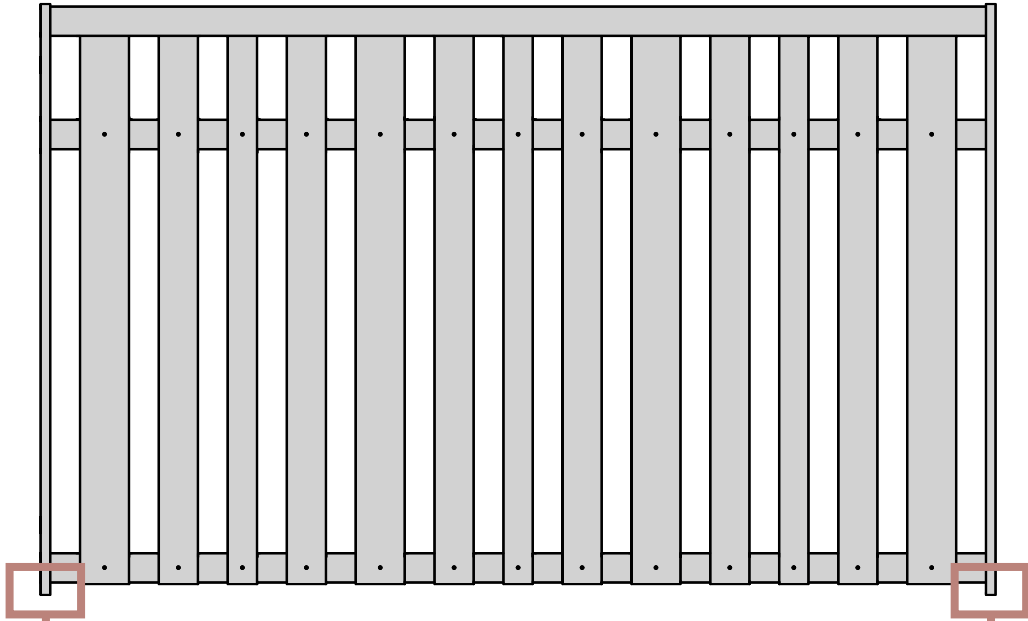
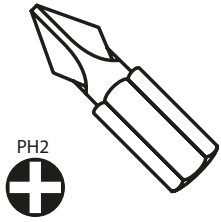

10

A

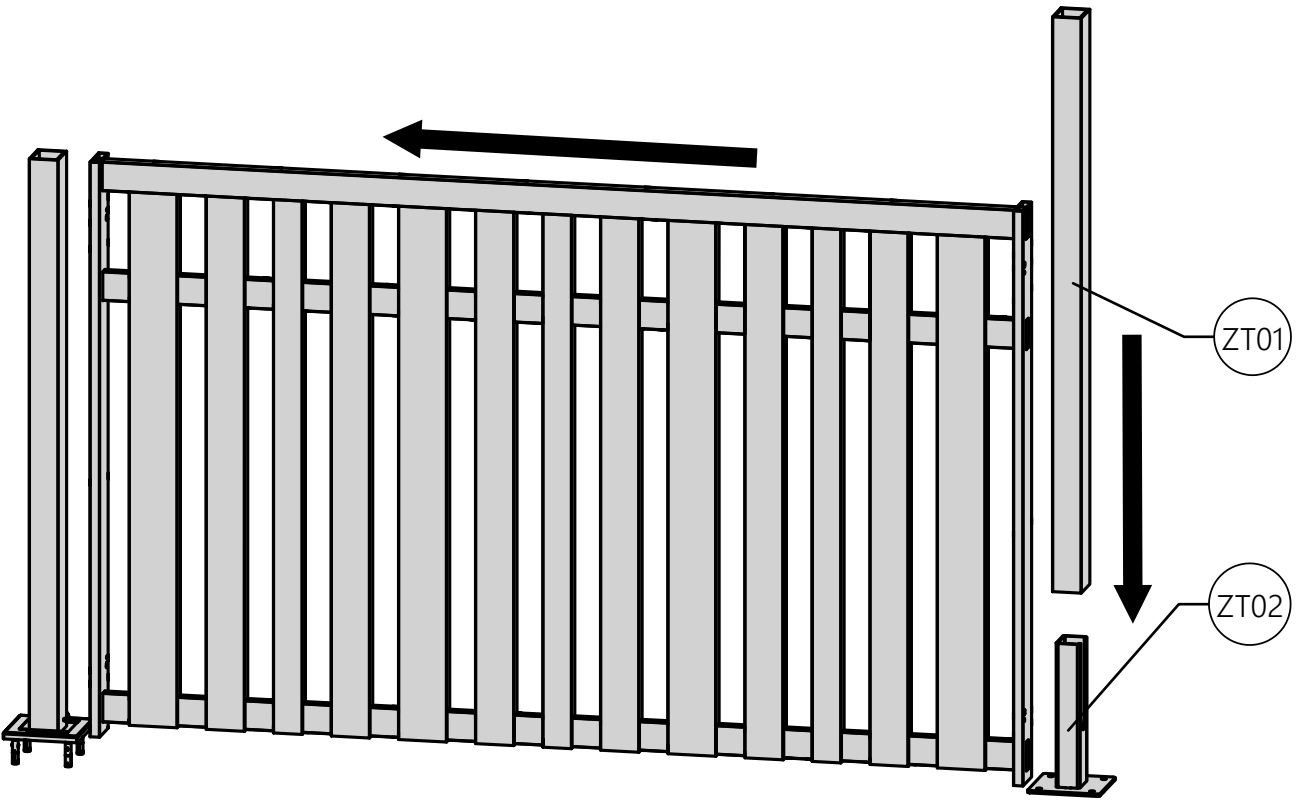
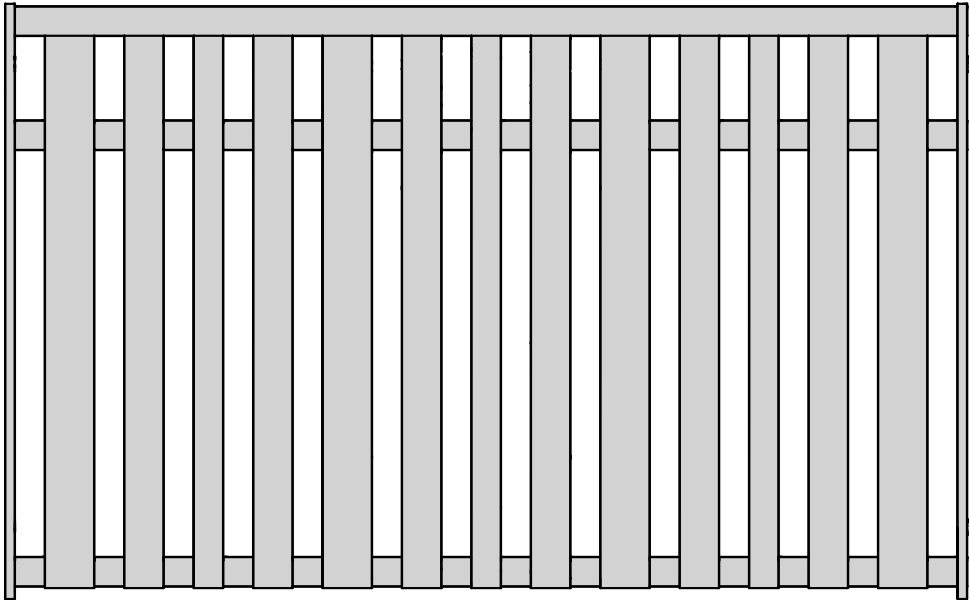

11

A

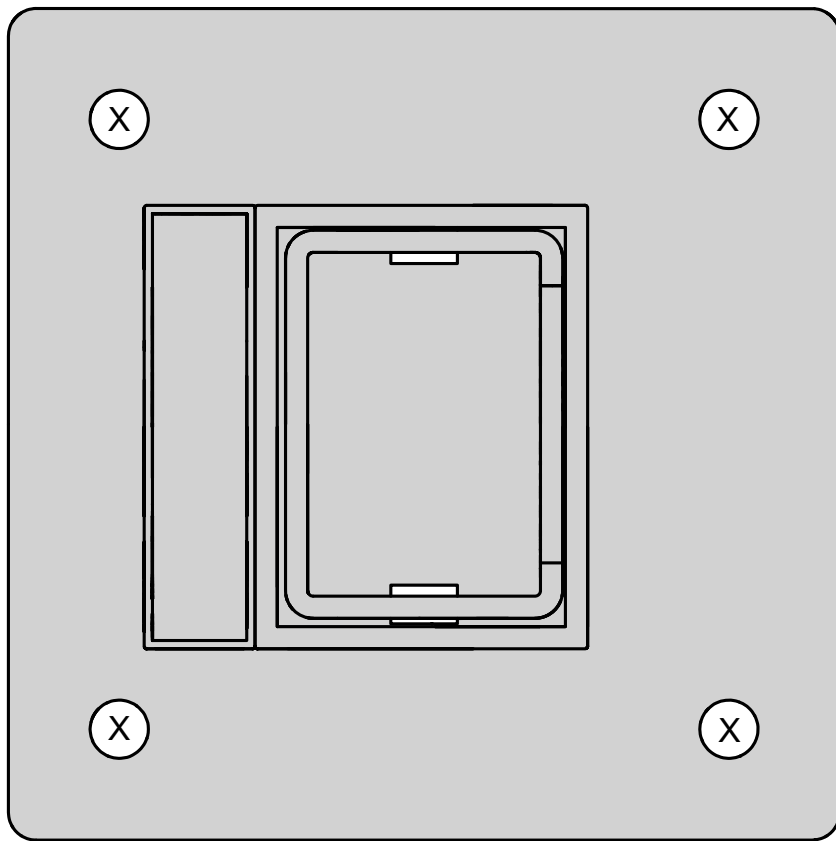
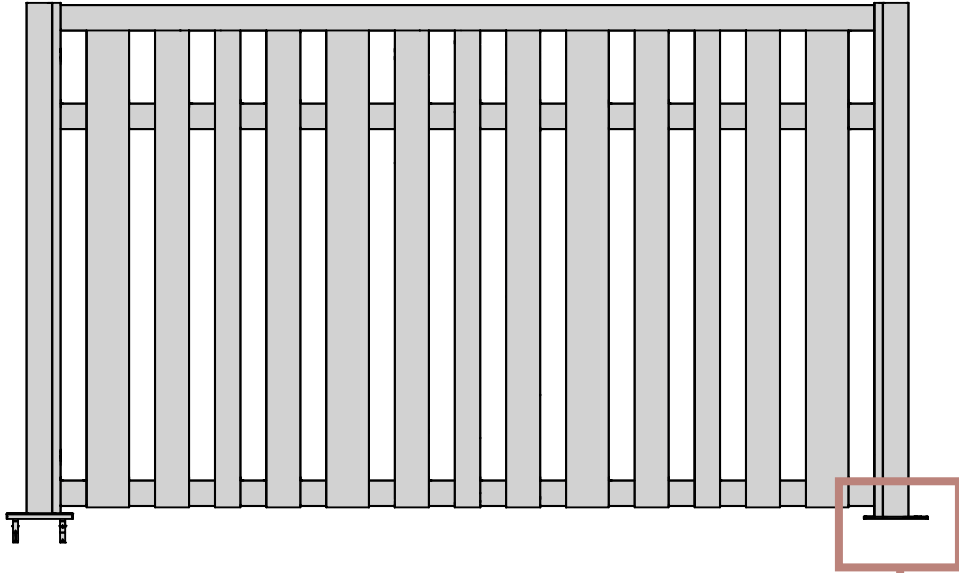
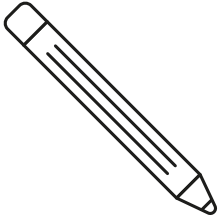

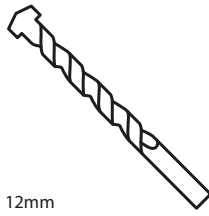
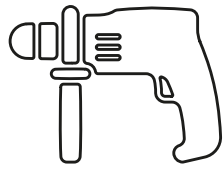

12mm

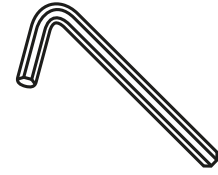
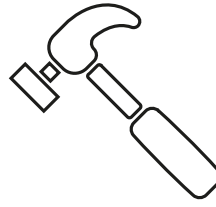

5mm

12

A

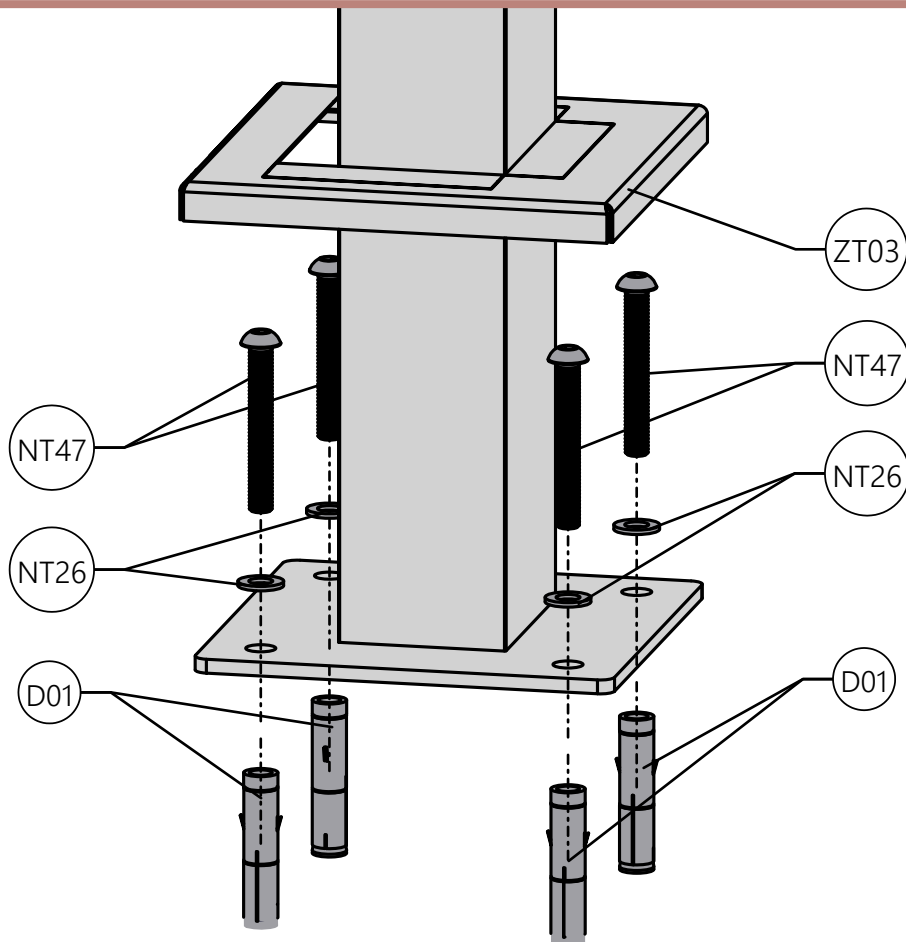
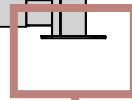
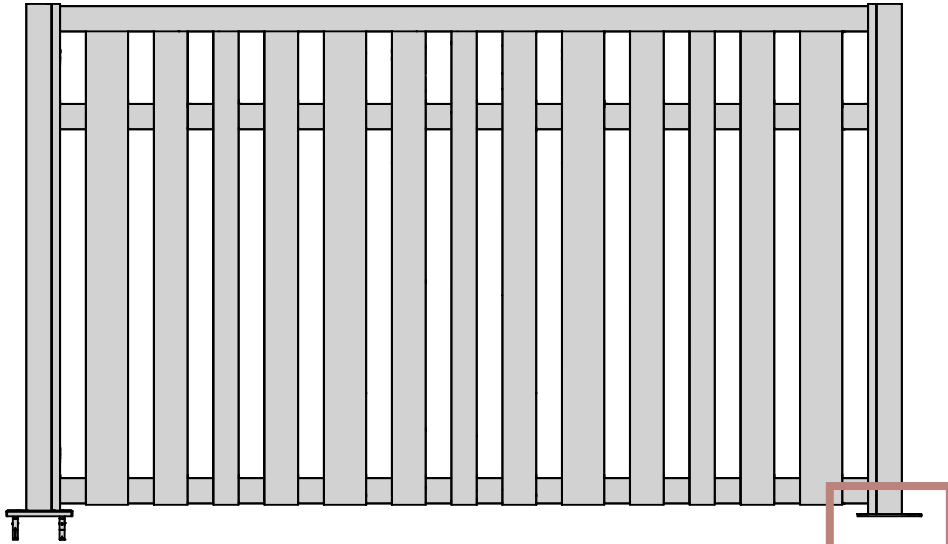

13

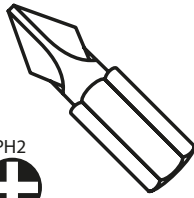

A

B

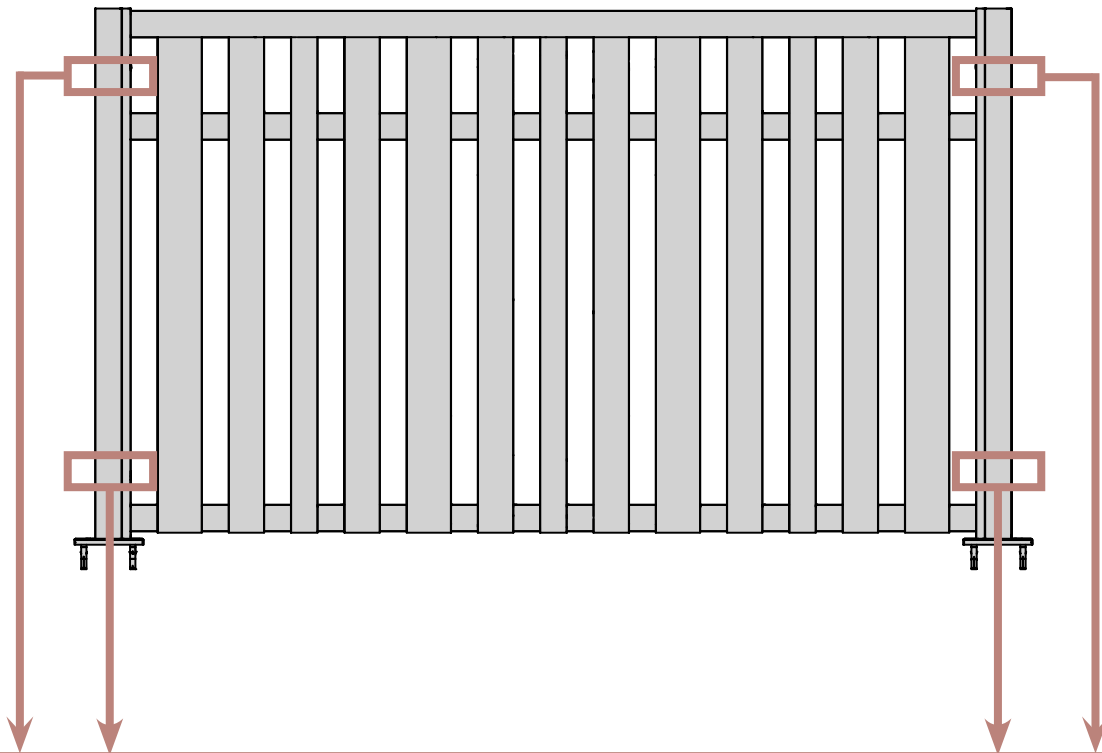

KS09

NT79

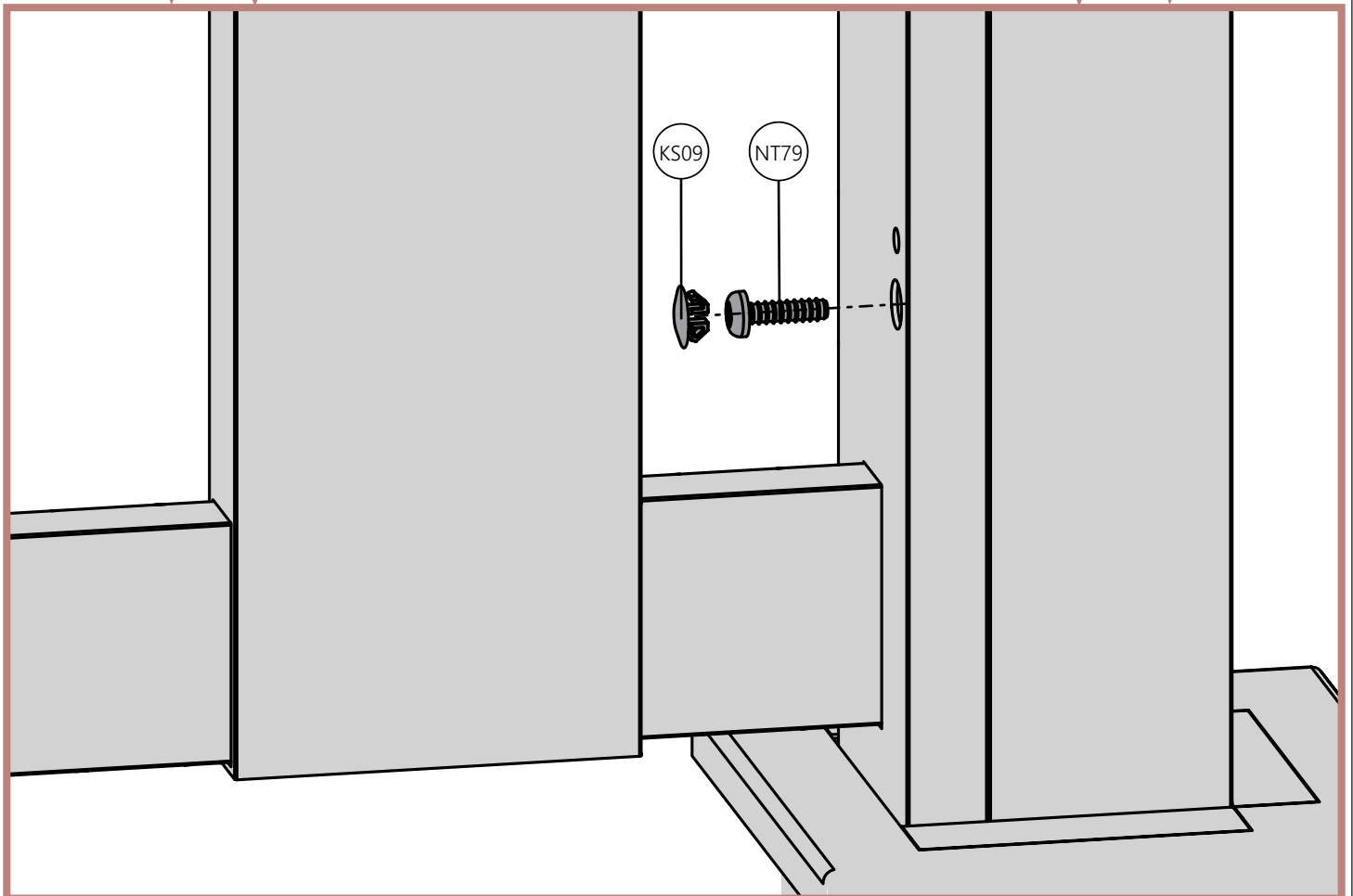

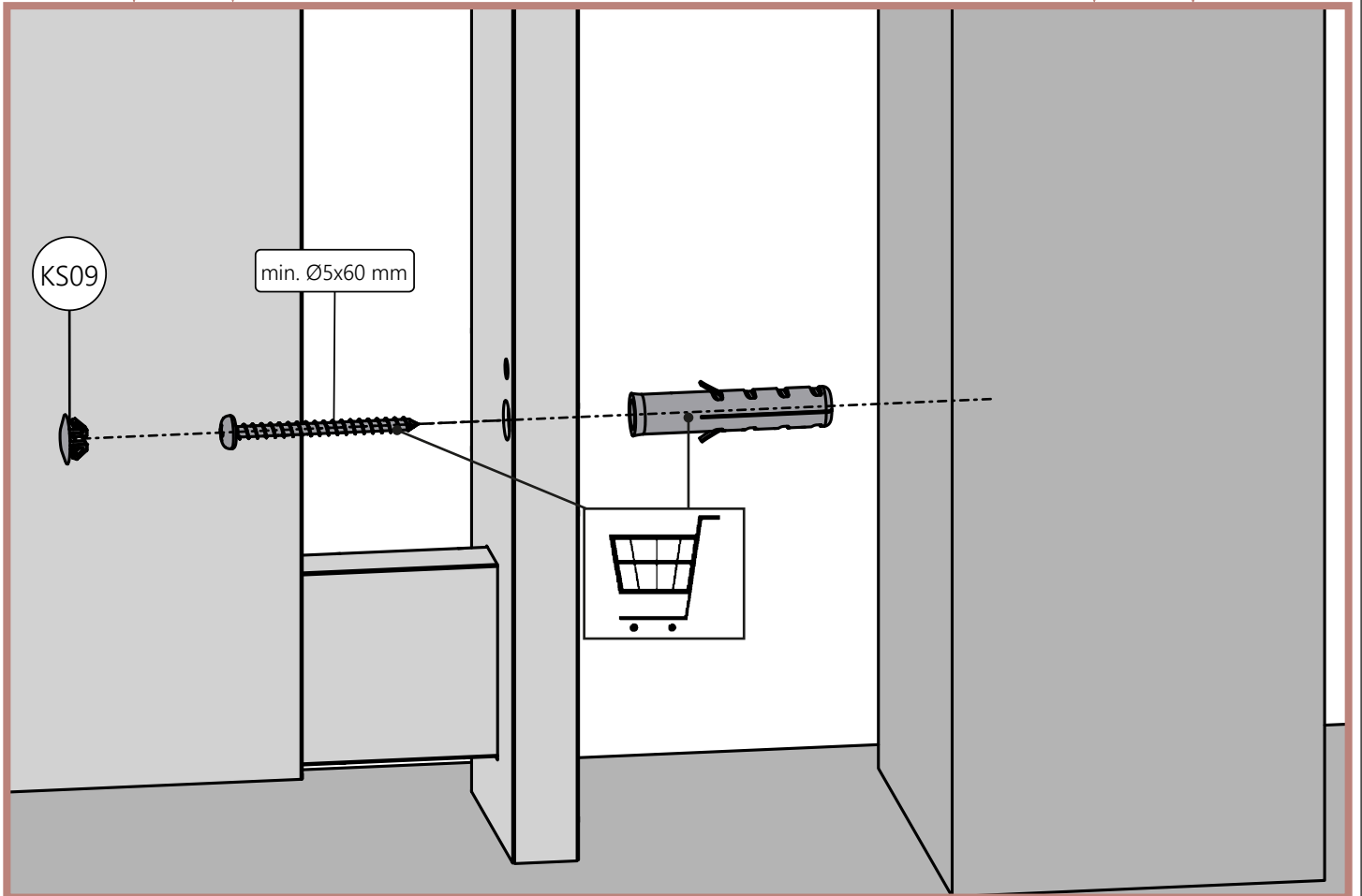
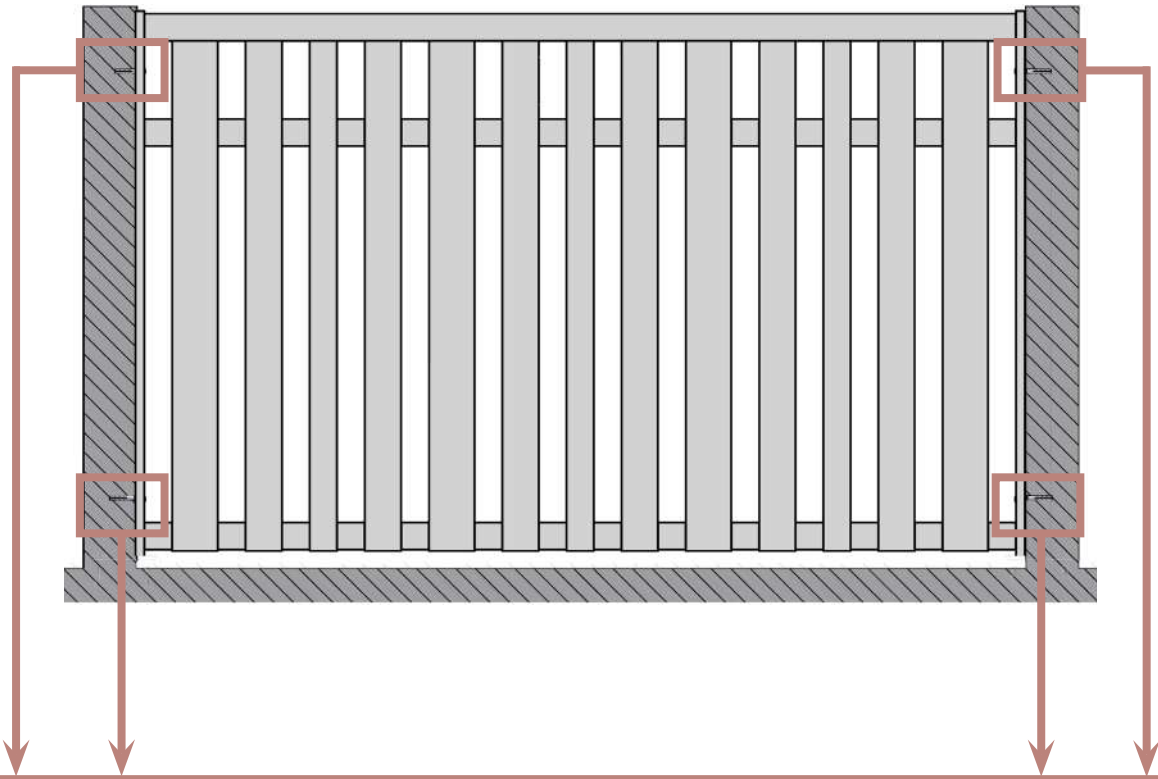
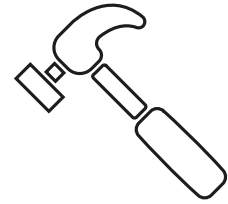
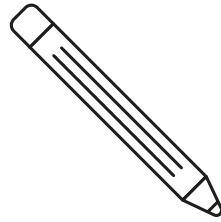
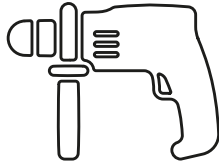
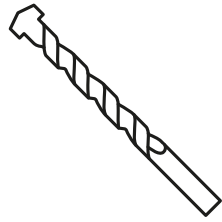

15

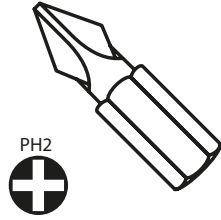
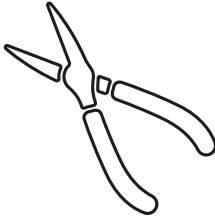

A

B

