

# Alex



**Alex** 1580† × 600⇔ SX  
couleur : RAL BRA

# Alex

## Raccordements :

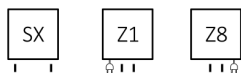

Version électrique :

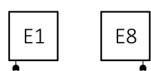

## Autres types de raccordement possibles :

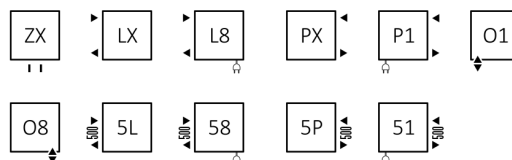

## Dimensions disponibles :

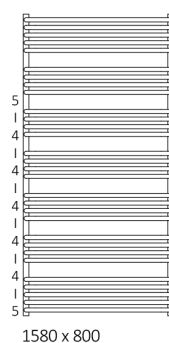
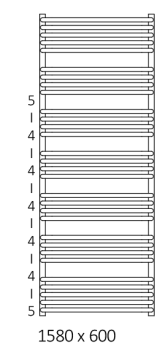
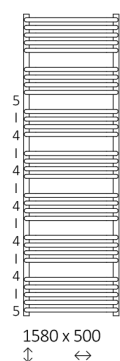
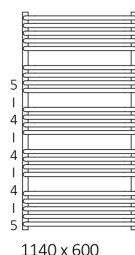
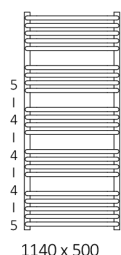
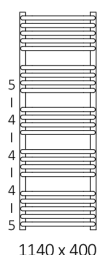
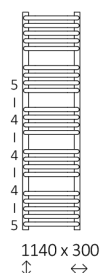
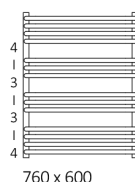
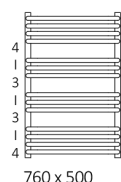
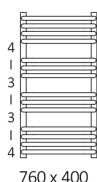
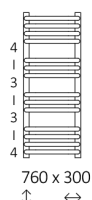
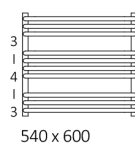
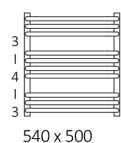
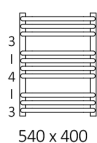
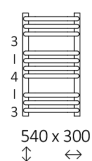



# Alex

## Données techniques :

Pression du travail : 1000 kPa

Température maximale de travail : 95°C

A ↓ [mm]	B ↔ [mm]	C1 [mm]	C2 [mm]	75/65/20°C [W]	55/45/20°C [W]	 [W]	D [mm]	E [mm]	F [mm]	 [dm³]	 [kg]
<b>Peinture epoxy</b>											
540	300	50	270	180	99	200	270	360	90	1,75	3,71
540	400	50	370	238	129	200	370	360	90	2,04	4,38
540	500	50	470	299	161	300	470	360	90	2,32	5,04
540	600	50	570	355	190	400	570	360	90	2,60	5,71
760	300	50	270	257	138	300	270	580	90	2,46	5,15
760	400	50	370	330	177	300	370	580	90	2,85	6,08
760	500	50	470	412	220	400	470	580	90	3,25	7,02
760	600	50	570	481	257	500	570	580	90	3,65	7,95
1140	300	50	270	362	194	400	270	960	90	3,78	7,86
1140	400	50	370	479	257	500	370	960	90	4,41	9,33
1140	500	50	470	591	313	600	470	960	90	5,03	10,8
1140	600	50	570	711	380	800	570	960	90	5,65	12,27
1580	500	50	470	793	425	800	470	1400	90	6,90	14,74
1580	600	50	570	949	508	1000	570	1400	90	7,75	16,75
1580	700	50	670	1104	591	1000	670	1400	90	8,60	18,75
1580	800	50	770	1253	670	1200	770	1400	90	9.45	20.76

# Alex

Dessin technique :

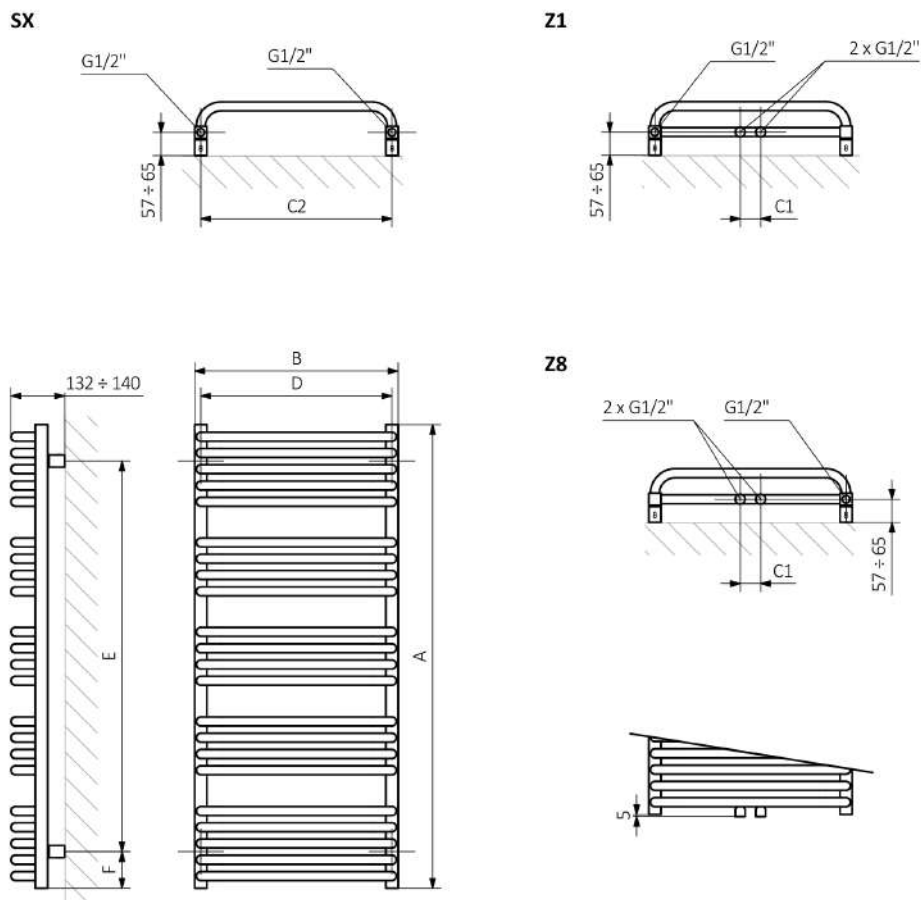

A - hauteur B - largeur C1-C5 - écartement des raccords D - écartement des consoles en horizontal  
E - écartement des consoles en vertical F - distance de l'axe de la console inférieure au bord inférieur du collecteur

Collecteur :

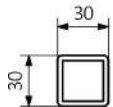

Tube :

