

# Easy

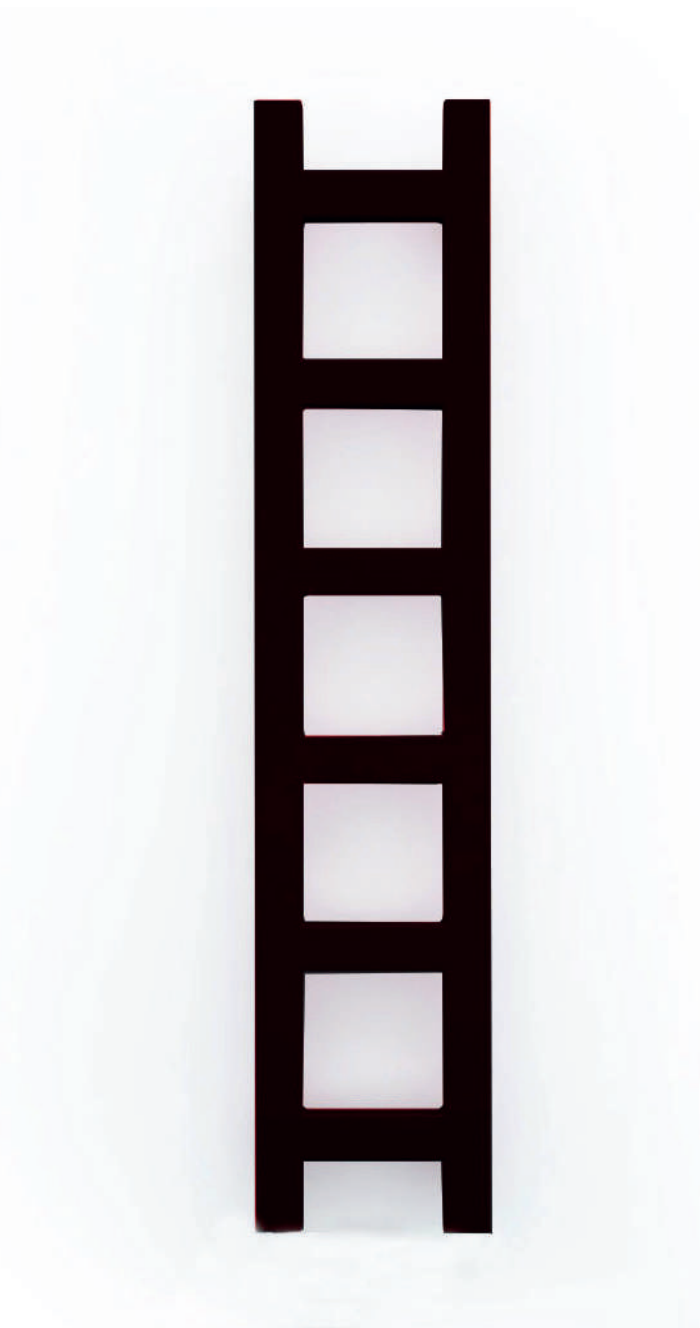

## Raccordements :

Sèche-serviette à eau chaude et mixte

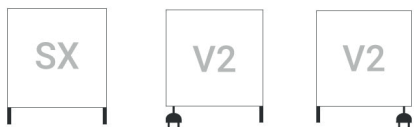

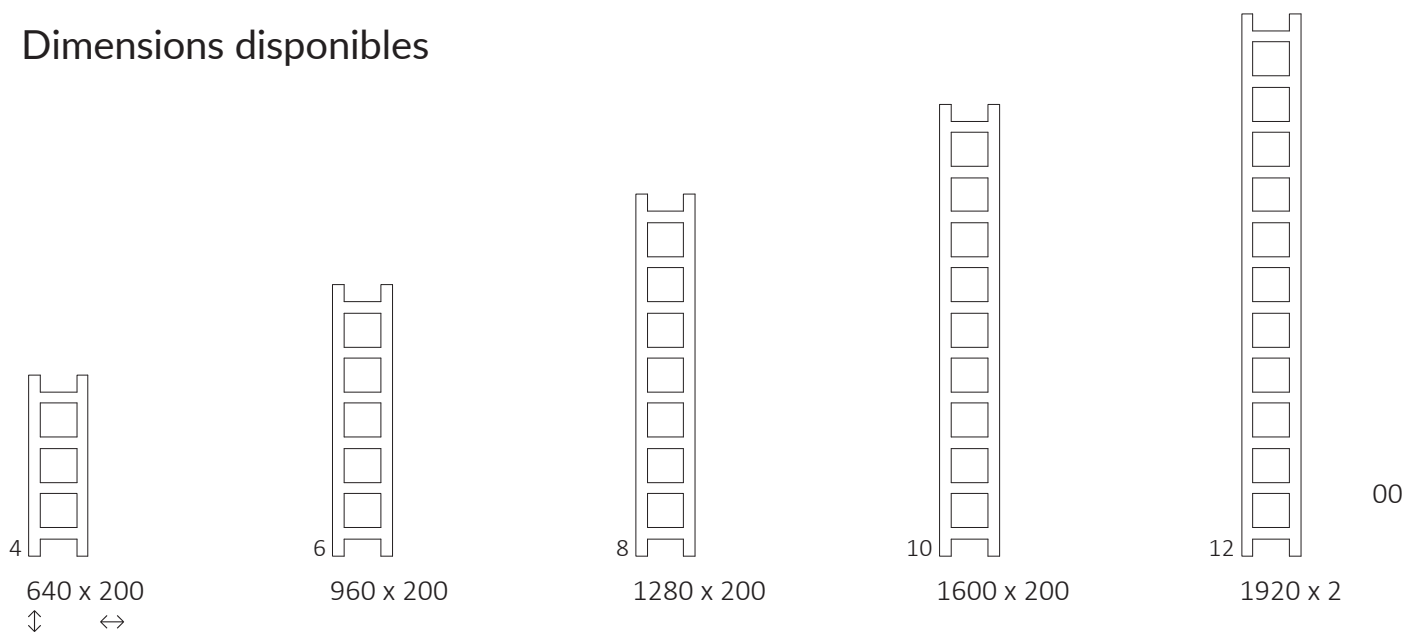

## Dimensions disponibles



## Données techniques :

Pression du travail : 800 kPa    Température maximale de travail : 95°C

A ↕ [mm]	B ↔ [mm]	C2 [mm]	75/65/20°C [W]	55/45/20°C [W]	 [W]	D [mm]	E [mm]	F [mm]	 [dm³]	 [kg]
<b>Peinture epoxy</b>										
640	200	160	124	68	100	160	320	160	1,76	3,01
960	200	160	187	102	200	160	640	160	2,64	4,40
1280	200	160	251	136	300	160	960	160	3,52	5,78
1600	200	160	314	170	300	160	1280	160	4,40	7,17
1920	200	160	378	204	400	160	1600	160	5,27	8,55
<b>Revêtement galvanique</b>										
640	200	160	87	44	100	160	320	160	1,76	2,92
960	200	160	131	67	100	160	640	160	2,64	4,26
1280	200	160	176	90	200	160	960	160	3,52	5,60
1600	200	160	220	112	200	160	1280	160	4,40	6,94

## Dessin technique :

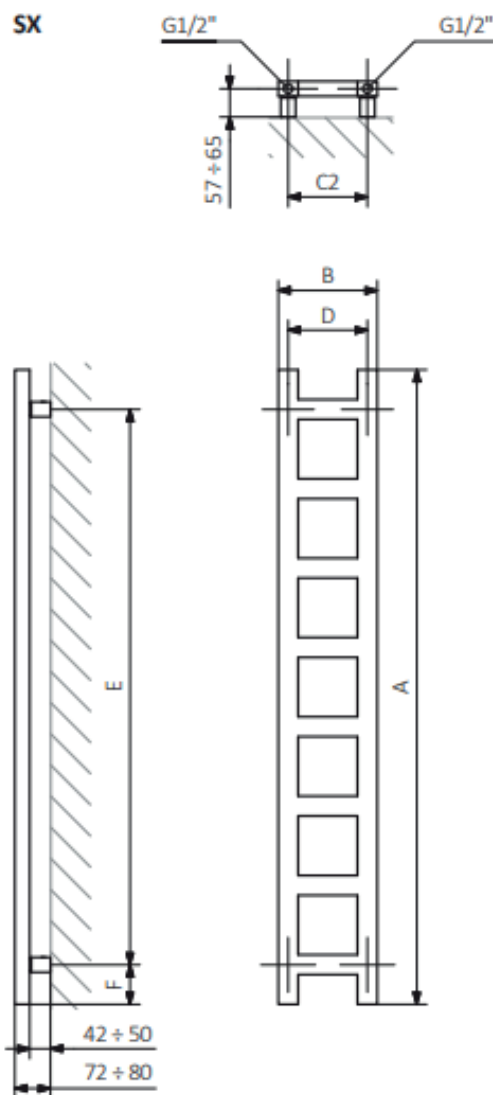

A – hauteur B – largeur C1-C5 – écartement des raccordements D – écartement des consoles en horizontal  
E – écartement des consoles en vertical F – distance de l'axe de la console inférieure au bord inférieur du collecteur

### Tube :

