

# Lima



**Lima** 500⇕ × 1000⇔ SX  
Farbe: RAL 8004

Anschlussgarnitur: Set Winkeleck-Thermostatventil, links, Chrom  
Set einteilige Blende, Chrom

# Lima

## Anschlusstypen

### Warmwasserbetrieb

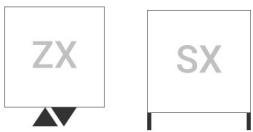

### Elektrobetrieb



### Mischbetrieb

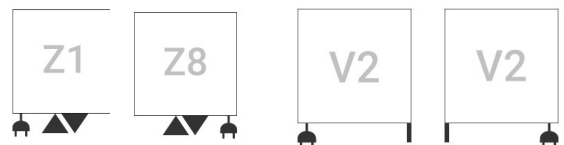

## Verfügbare Größen

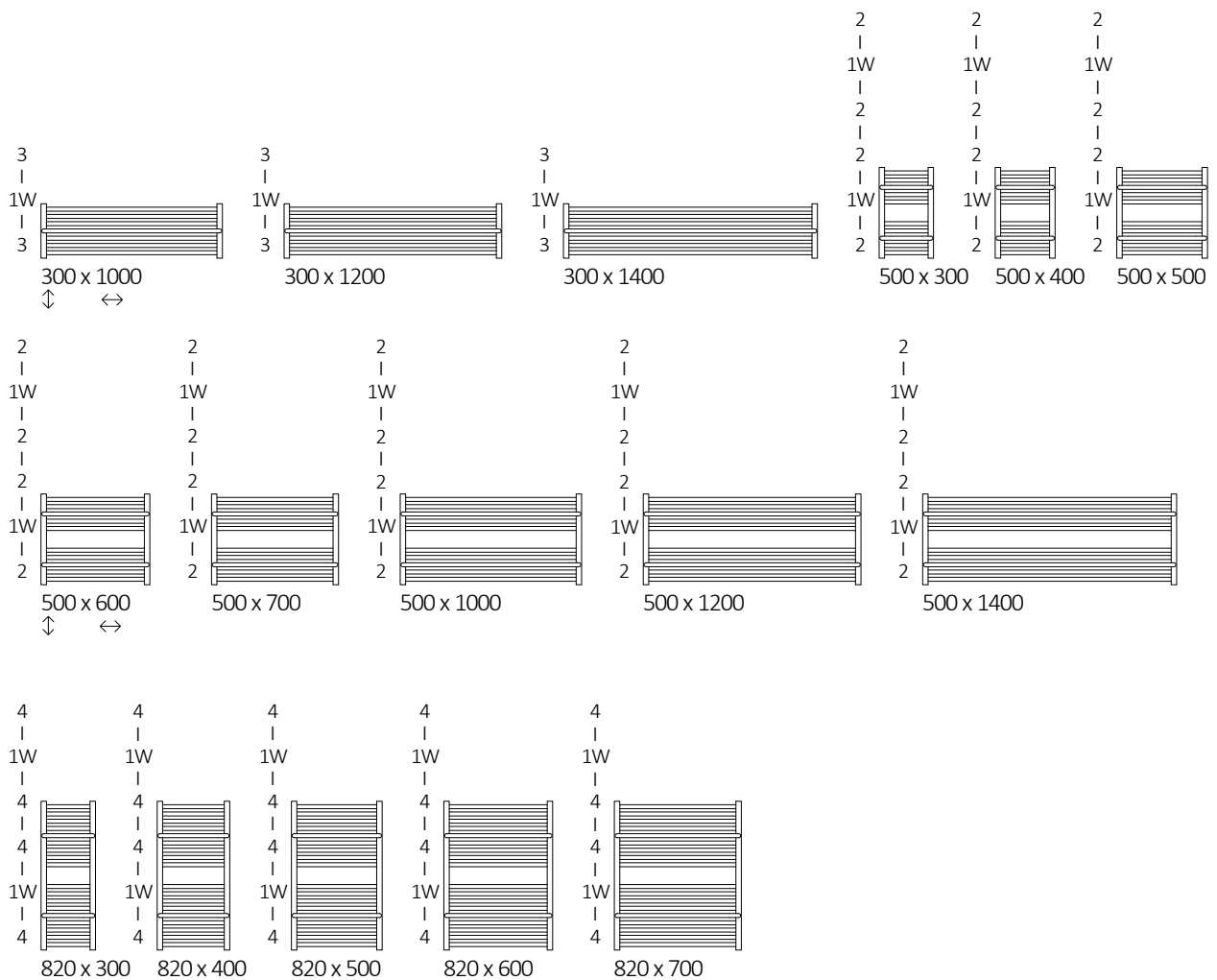

# Lima

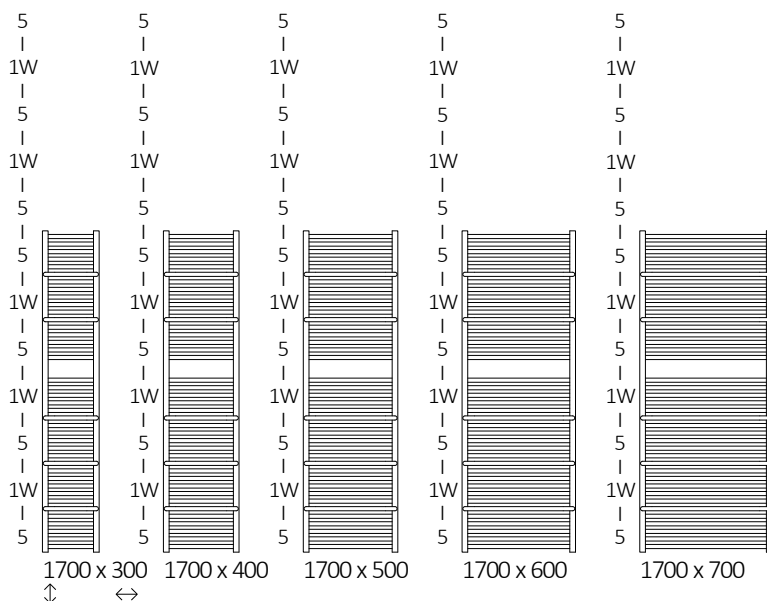
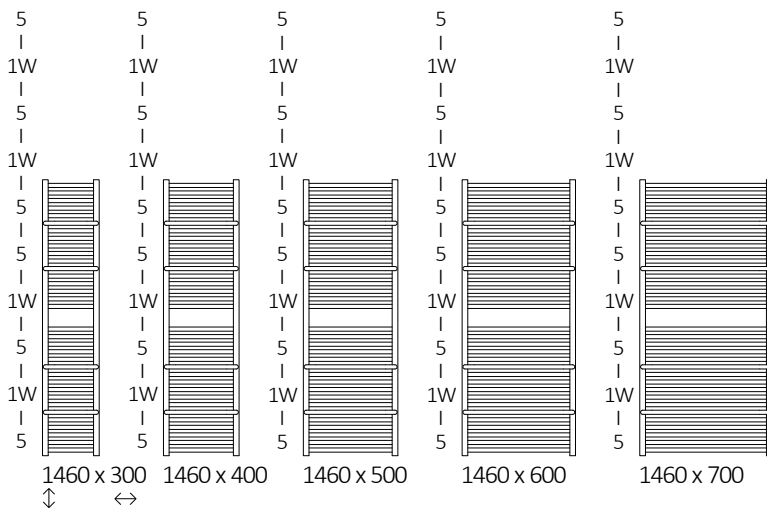
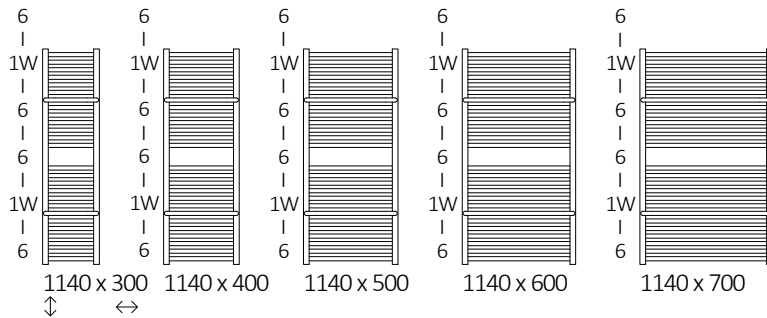

## Verfügbare Größen



# Lima

## Technische Daten

Betriebsdruck: 1000 kPa      Maximale Betriebstemperatur: 95°C



A ↑ [mm]	B ↔ [mm]	C1 [mm]	55/20°C [W]	55/42°C [W]	 [W]	D [mm]	E [mm]	F [mm]	H [dm²]	 [kg]	Artikelnummer <small>Kosten konfigurieren &gt;&gt;</small>
<b>Pulverlack</b>											
300	1000	50	290	159	-	970	120	90	2,43	5,28	WGLIM030100
300	1200	50	347	191	-	1170	120	90	2,85	6,21	WGLIM030120
300	1400	50	405	223	-	1370	120	90	3,26	7,15	WGLIM030140
500	300	50	144	79	120	270	320	90	1,50	3,06	WGLIM050030
500	400	50	192	105	200	370	320	90	1,79	3,72	WGLIM050040
500	500	50	241	131	200	470	320	90	2,09	4,39	WGLIM050050
500	600	50	282	153	300	570	320	90	2,39	5,06	WGLIM050060
500	700	50	324	176	300	670	320	90	2,69	5,73	WGLIM050070
500	1000	50	482	262	-	970	320	90	3,59	7,73	WGLIM050100
500	1200	50	578	314	-	1170	320	90	4,18	9,07	WGLIM050120
500	1400	50	675	367	-	1370	320	90	4,78	10,41	WGLIM050140
820	300	50	244	132	300	270	640	90	2,53	5,14	WGLIM082030
820	400	50	228	116	200	370	640	90	3,07	6,34	WGLIM082040
820	500	50	406	218	400	470	640	90	3,61	7,54	WGLIM082050
820	600	50	477	256	400	570	640	90	4,15	8,75	WGLIM082060
820	700	50	547	293	600	670	640	90	4,68	9,95	WGLIM082070
1140	300	50	345	185	400	270	960	90	3,57	7,22	WGLIM114030
1140	400	50	460	247	400	370	960	90	4,35	8,96	WGLIM114040
1140	500	50	574	308	600	470	960	90	5,13	10,69	WGLIM114050
1140	600	50	675	361	800	570	960	90	5,90	12,43	WGLIM114060
1140	700	50	776	415	800	670	960	90	6,68	14,17	WGLIM114070
1460	300	50	449	240	400	270	1280	90	4,66	9,42	WGLIM146030
1460	400	50	599	319	600	370	1280	90	5,68	11,69	WGLIM146040
1460	500	50	748	399	800	470	1280	90	6,69	13,96	WGLIM146050
1460	600	50	879	468	800	570	1280	90	7,71	16,23	WGLIM146060
1460	700	50	1009	537	1000	670	1280	90	8,73	18,50	WGLIM146070
1700	300	50	527	280	600	270	1520	90	5,47	11,04	WGLIM170030
1700	400	50	703	374	800	370	1520	90	6,66	13,71	WGLIM170040
1700	500	50	878	466	800	470	1520	90	7,86	16,38	WGLIM170050
1700	600	50	1031	547	1000	570	1520	90	9,05	19,05	WGLIM170060
1700	700	50	1183	628	1200	670	1520	90	10,25	21,73	WGLIM170070

# Lima

## Technische Daten

Betriebsdruck: 1000 kPa

Maximale Betriebstemperatur: 95°C

A ↑ [mm]	B ↔ [mm]	C1 [mm]	55/30°C [W]	55/42°C [W]	 [W]	D [mm]	E [mm]	F [mm]	H [dm <sup>2</sup> ]	 [kg]	Artikelnummer <small>Handtuchheizkörper GmbH</small>
<b>Galvanische Oberfläche</b>											
300	1000	50	203	104	-	970	120	90	2,43	5,07	WGLIM030100
300	1200	50	243	124	-	1170	120	90	2,85	5,96	WGLIM030120
300	1400	50	284	145	-	1370	120	90	3,26	6,86	WGLIM030140
500	300	50	101	51	120	270	320	90	1,50	2,94	WGLIM050030
500	400	50	134	69	120	370	320	90	1,79	3,58	WGLIM050040
500	500	50	169	86	200	470	320	90	2,09	4,22	WGLIM050050
500	600	50	197	101	200	570	320	90	2,39	4,86	WGLIM050060
500	700	50	227	116	200	670	320	90	2,69	5,50	WGLIM050070
500	1000	50	337	172	-	970	320	90	3,59	7,43	WGLIM050100
500	1200	50	405	206	-	1170	320	90	4,18	8,71	WGLIM050120
500	1400	50	473	241	-	1370	320	90	4,78	9,99	WGLIM050140
820	300	50	171	87	200	270	640	90	2,53	4,94	WGLIM082030
820	400	50	228	116	200	370	640	90	3,07	6,10	WGLIM082040
820	500	50	284	145	300	470	640	90	3,61	7,25	WGLIM082050
820	600	50	334	170	400	570	640	90	4,15	8,40	WGLIM082060
820	700	50	383	195	400	670	640	90	4,68	9,55	WGLIM082070
1140	300	50	242	123	300	270	960	90	3,57	6,94	WGLIM114030
1140	400	50	322	164	300	370	960	90	4,35	8,61	WGLIM114040
1140	500	50	402	205	400	470	960	90	5,13	10,27	WGLIM114050
1140	600	50	473	241	400	570	960	90	5,90	11,94	WGLIM114060
1140	700	50	543	277	600	670	960	90	6,68	13,61	WGLIM114070
1460	300	50	314	160	300	270	1280	90	4,66	9,06	WGLIM146030
1460	400	50	419	214	400	370	1280	90	5,68	11,24	WGLIM146040
1460	500	50	524	267	600	470	1280	90	6,69	13,41	WGLIM146050
1460	600	50	615	314	600	570	1280	90	7,71	15,59	WGLIM146060
1460	700	50	706	360	800	670	1280	90	8,73	17,77	WGLIM146070
1700	300	50	369	188	400	270	1520	90	5,47	10,62	WGLIM170030
1700	400	50	492	251	600	370	1520	90	6,66	13,18	WGLIM170040
1700	500	50	615	313	600	470	1520	90	7,86	15,74	WGLIM170050
1700	600	50	722	368	800	570	1520	90	9,05	18,30	WGLIM170060
1700	700	50	828	422	800	670	1520	90	10,25	20,86	WGLIM170070

# Lima

## Technische Zeichnung:

SX

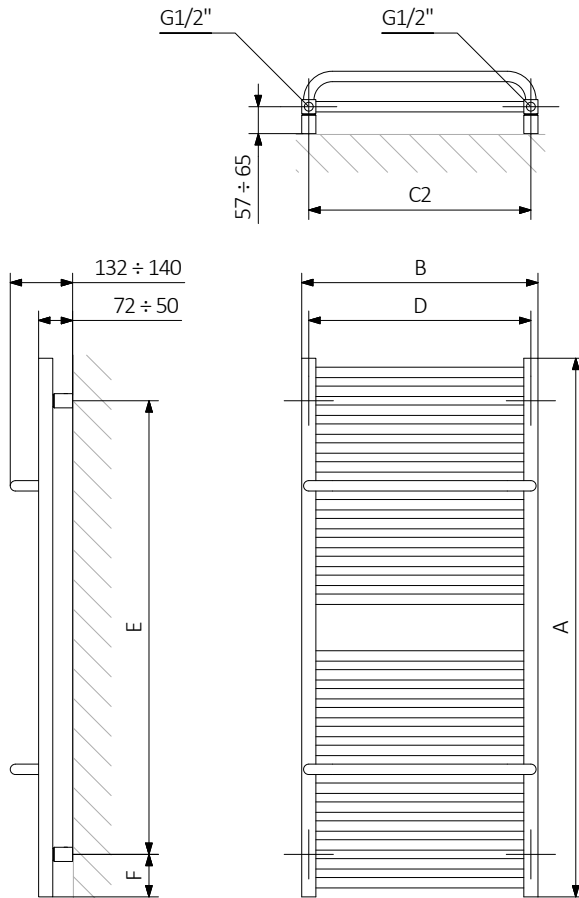

Z1

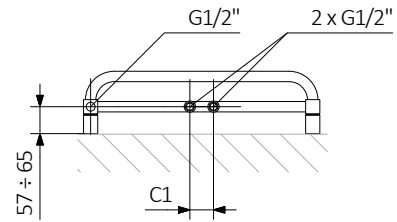

Z8

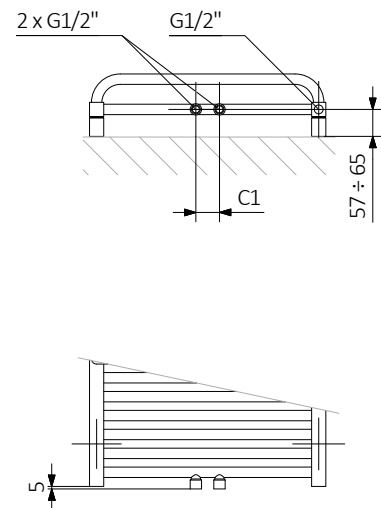

A – Höhe B – Breite C1-C5 – Anschlussabstand D – horizontaler Wandhalterungsabstand E – Vertikaler Wandhalterungsabstand  
F – Abstand von der Achse der unteren Wandhalterung bis Unterkante des Kollektors

**Kollektor:**

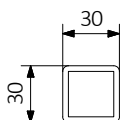

**Rohr:**

