

	STEPS	H [mm]	L [mm]	S [mm]
A	4+1	915 - 1150	1090 - 912	180 - 230
	5+1	1095 - 1380	1330 - 1090	180 - 230
	6+1	1275 - 1612	1560 - 1270	180 - 230
B	8+1	1635 - 2072	2020 - 1630	180 - 230
	9+1	1815 - 2302	2250 - 1809	180 - 230
	10+1	1995 - 2532	2477 - 1990	180 - 230
C	12+1	2355 - 2992	2937 - 2350	180 - 230
D	13+1	2532 - 3222	3170 - 2530	180 - 230
	14+1	2715 - 3452	3400 - 2710	180 - 230

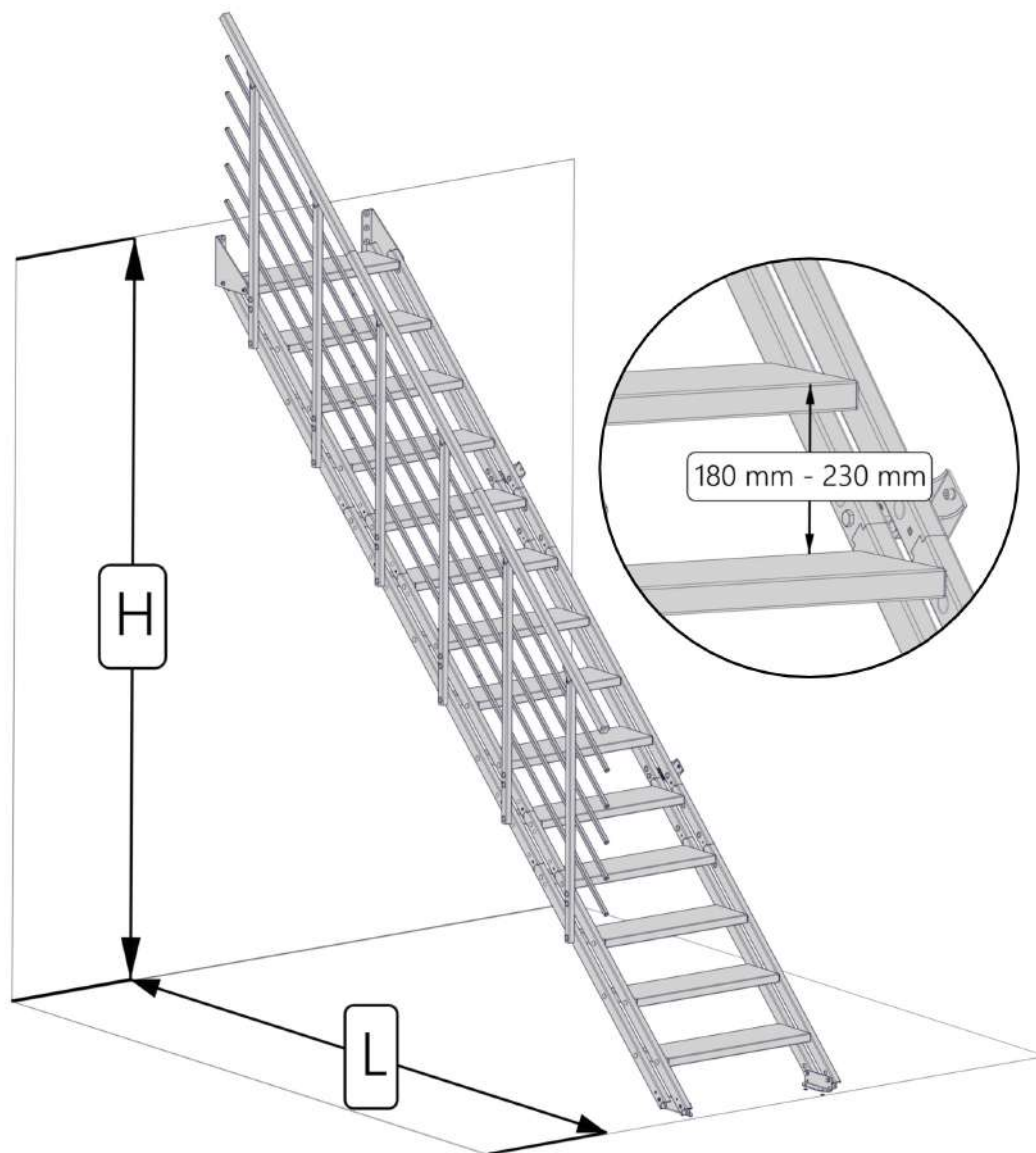

A

4+1 STEPS

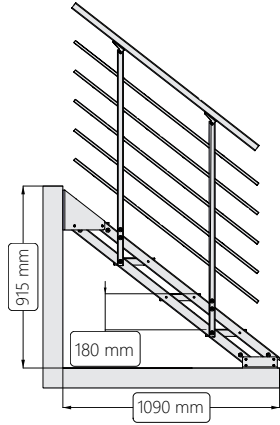
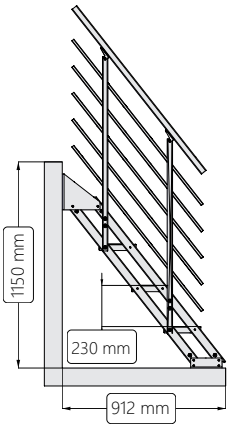

A

5+1 STEPS

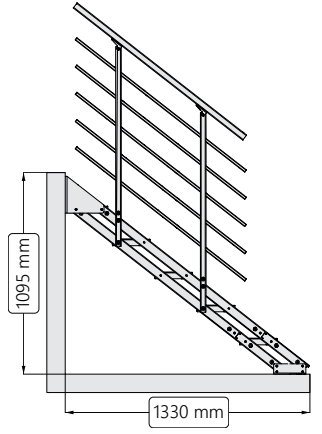
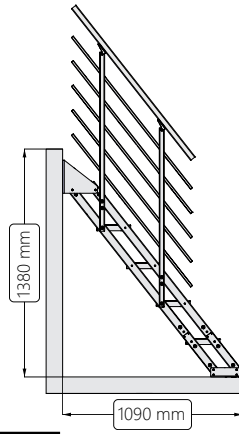

A

6+1 STEPS

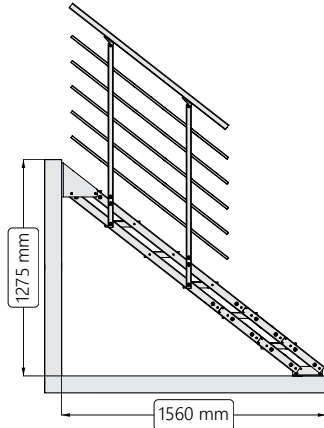
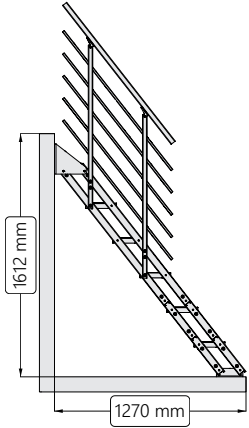

B

8+1 STEPS

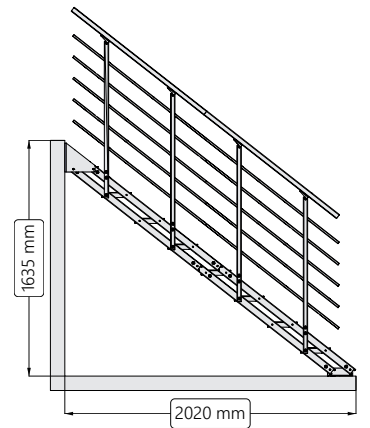
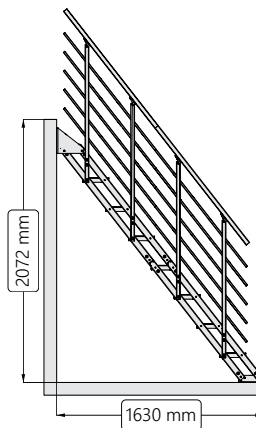

B

9+1 STEPS

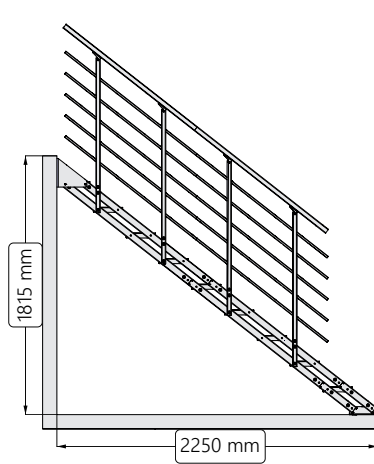
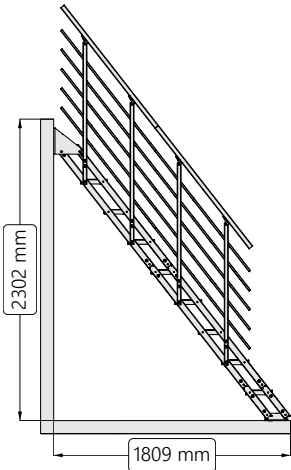

B

10+1 STEPS

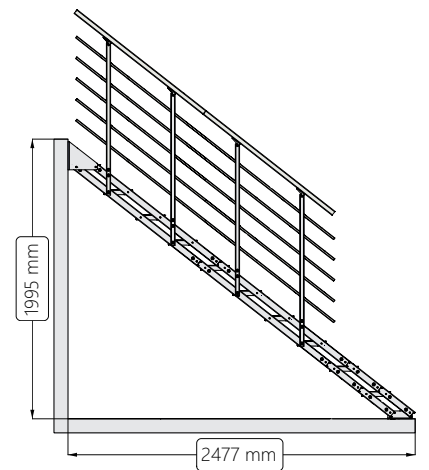
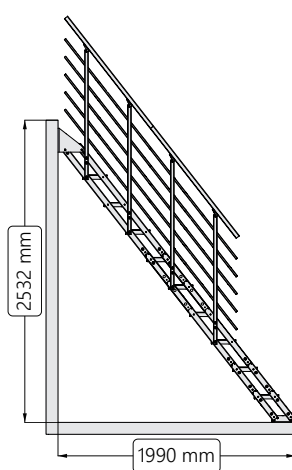

C

12+1 STEPS

D

13+1 STEPS

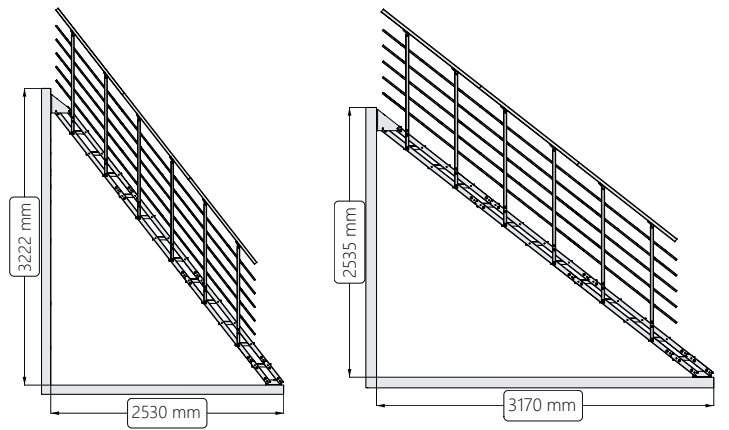
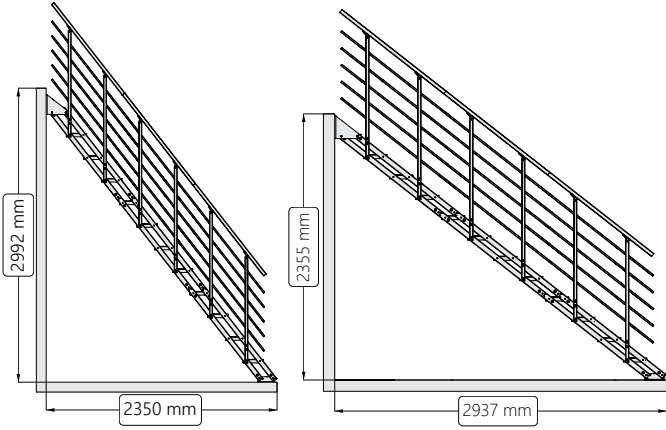

D

14+1 STEPS

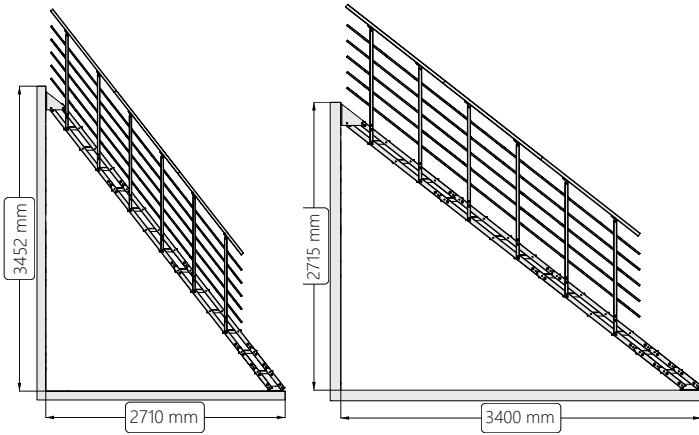

A=14x
B=14x
C=14x
D=14x

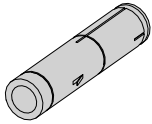

D01 Ø12mm

A=10x
B=10x
C=10x
D=10x

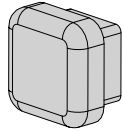

KS08 15x15mm

A=10x
B=20x
C=30x
D=30x

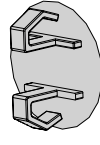

KS09 Ø13mm

A=30x
B=44x
C=42x
D=58x

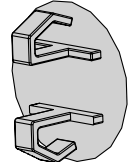

KS10 Ø20mm

A=2x
B=2x
C=2x
D=2x

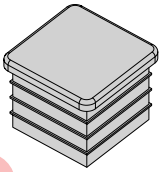

KS14 34x34mm

A=2x
B=4x
C=6x
D=6x

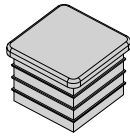

KS16 30x30mm

A=4x
B=4x
C=4x
D=4x

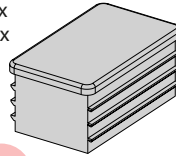

KS17 50x30mm

A=0x
B=5x
C=10x
D=10x

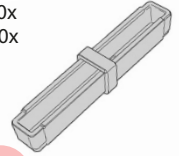

KS24 12x12x80mm

A=24x
B=54x
C=72x
D=76x

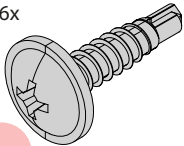

NT07 Ø4.2x19mm

A=26x
B=34x
C=26x
D=42x

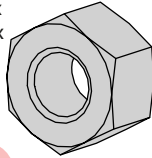

NT24 M8

A=74x
B=104x
C=110x
D=134x

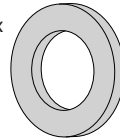

NT26 M8 DIN125A

A=6x
B=6x
C=6x
D=6x

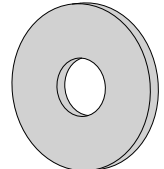

NT37 M8 DIN9021

A=16x
B=24x
C=16x
D=32x

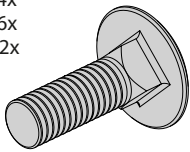

NT41 M8x25mm

A=12x
B=12x
C=12x
D=12x

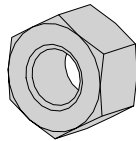

NT45 M6

A=12x
B=12x
C=12x
D=12x

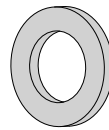

NT50 M6 DIN125A

A=30x
B=38x
C=24x
D=46x

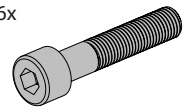

NT54 M8x55mm

A=12x
B=12x
C=12x
D=12x

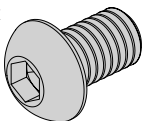

NT68 M6x10mm

A=22x
B=36x
C=42x
D=50x

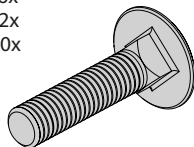

NT72 M8x40mm

A=0x
B=1x
C=2x
D=2x

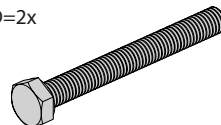

NT73 M8x90mm

A=32x
B=48x
C=52x
D=64x

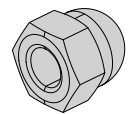

NT74 M8

A=6x
B=8x
C=10x
D=10x

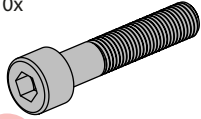

NT75 M8x40mm

A=4x
B=8x
C=12x
D=12x

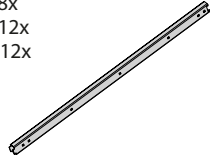

ST57

A=8x
B=8x
C=0x
D=8x

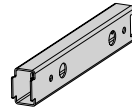

ST58

A=1x
B=1x
C=1x
D=1x

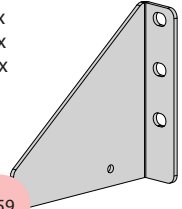

ST59

A=1x
B=1x
C=1x
D=1x

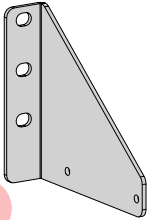

ST60

A=2x
B=2x
C=2x
D=2x

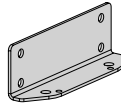

ST61

A=8x
B=12x
C=8x
D=16x

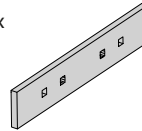

ST62

A=8x
B=12x
C=8x
D=16x

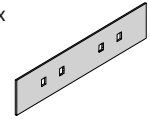

ST63

A=2x
B=4x
C=6x
D=6x

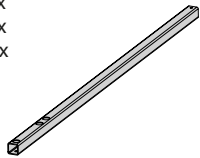

ST64 30x30x1085mm

A=1x
B=2x
C=3x
D=3x

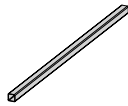

ST65 35x35x1168mm

A=5x
B=10x
C=15x
D=15x



ST66 15x15x1168mm

A=0x
B=1x
C=2x
D=2x

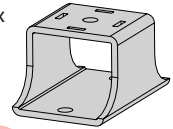

ST70

A=0x
B=1x
C=2x
D=2x

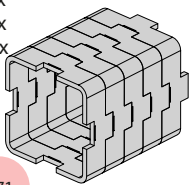

ST71

A=6x
B=10x
C=12x
D=14x

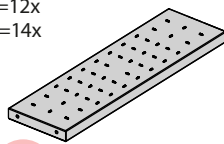

ST116

A=2x
B=4x
C=6x
D=6x

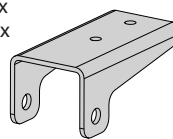

ST125

A=0x
B=1x
C=2x
D=2x

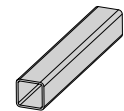

ST129 30x30x200mm

A=6x
B=10x
C=12x
D=14x

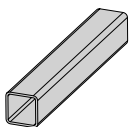

ST162 20x20x195mm

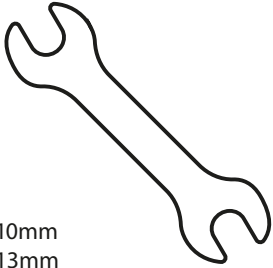

10mm
13mm

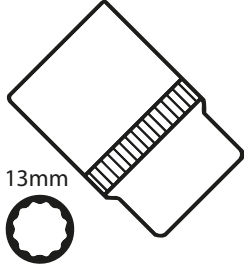

13mm

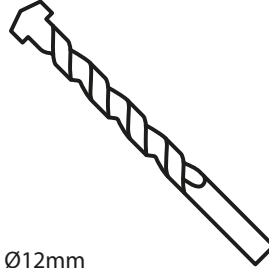

Ø12mm

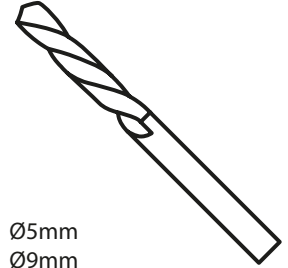

Ø5mm
Ø9mm

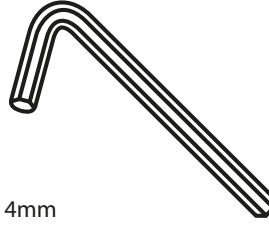
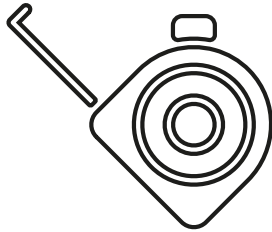
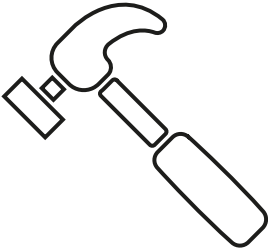

4mm
5mm

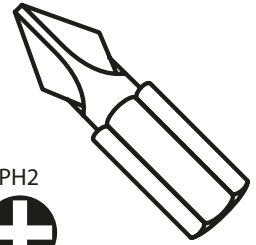

PH2

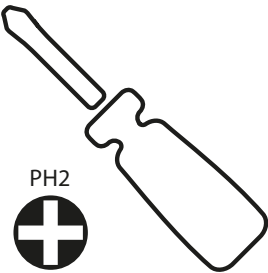

PH2

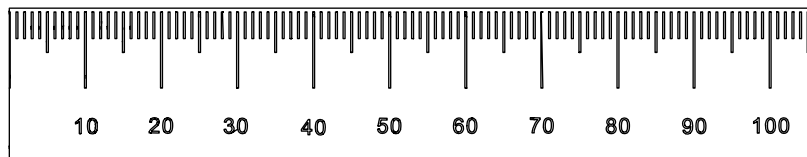
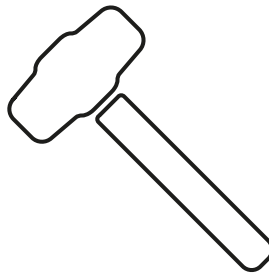
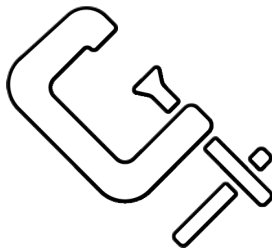
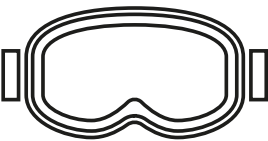
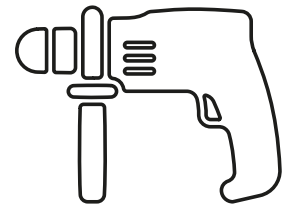
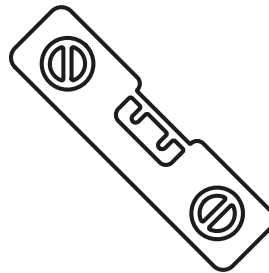
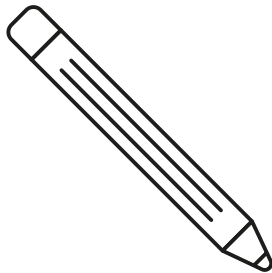

A

4+1 STEPS

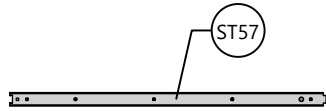

5+1 STEPS

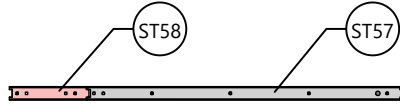

6+1 STEPS

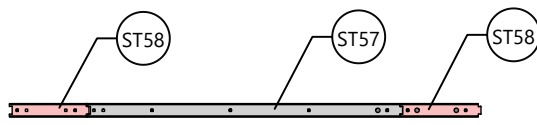

B

8+1 STEPS



9+1 STEPS

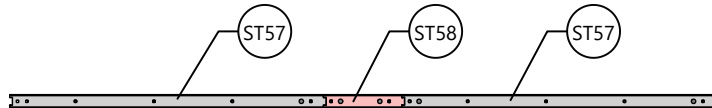

10+1 STEPS

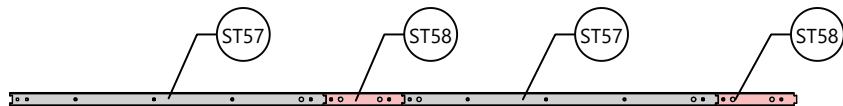

C

12+1 STEPS

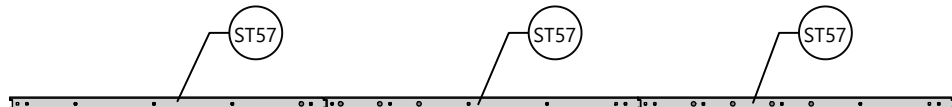

D

13+1 STEPS



14+1 STEPS

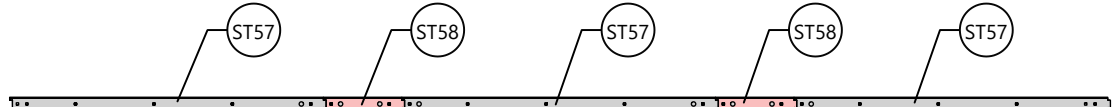

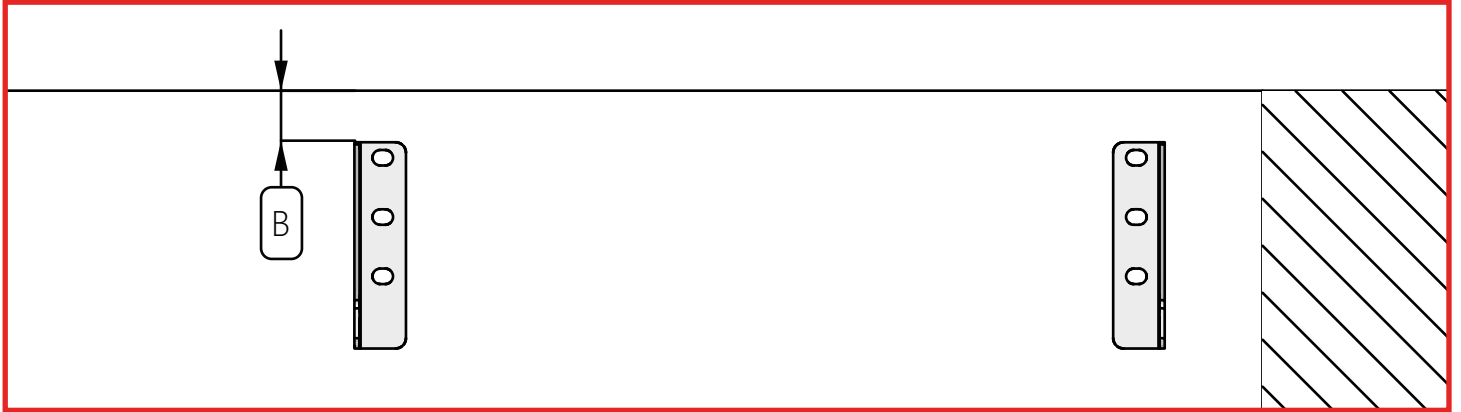

$$S(\text{mm}) = \frac{H}{n + 1}$$

$$B(\text{mm}) = \frac{H - S}{n} - 162.5$$

Steps = n = 1...14

$$H = 3000 \text{ mm} \quad n = 14$$

$$S(\text{mm}) = \frac{(H = 3000 \text{ mm})}{(n = 14) + 1} = 200 \text{ mm}$$

$$B(\text{mm}) = \frac{(H = 3000 \text{ mm}) - (S = 200 \text{ mm})}{(n = 14)} - 162.5 = 37.5 \text{ mm}$$

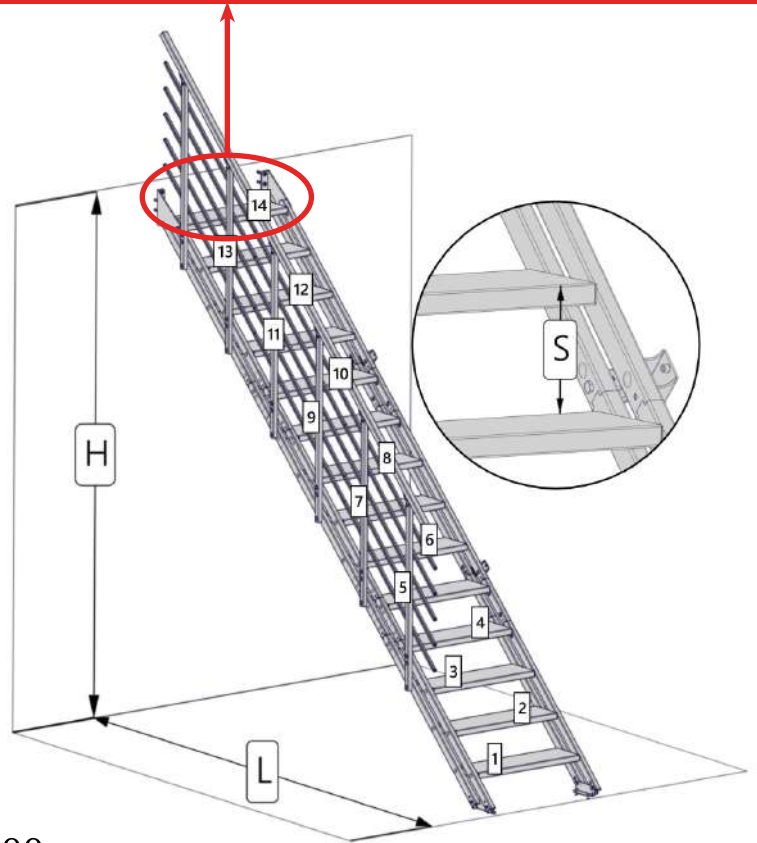

1

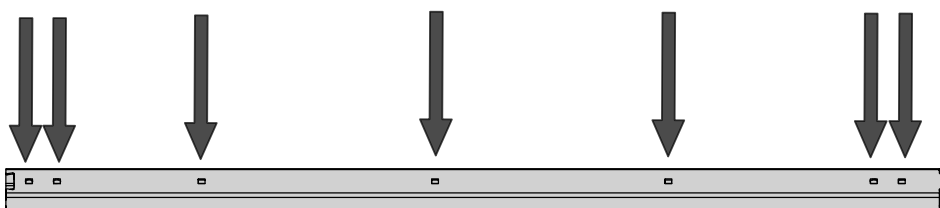
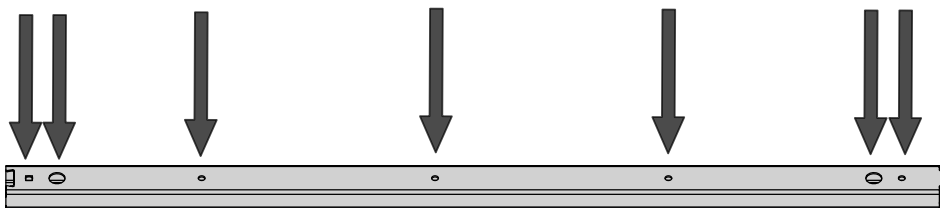
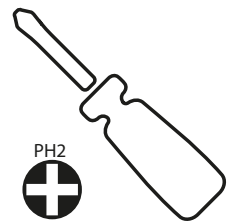
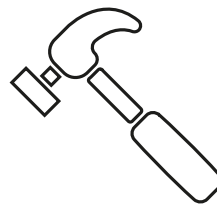
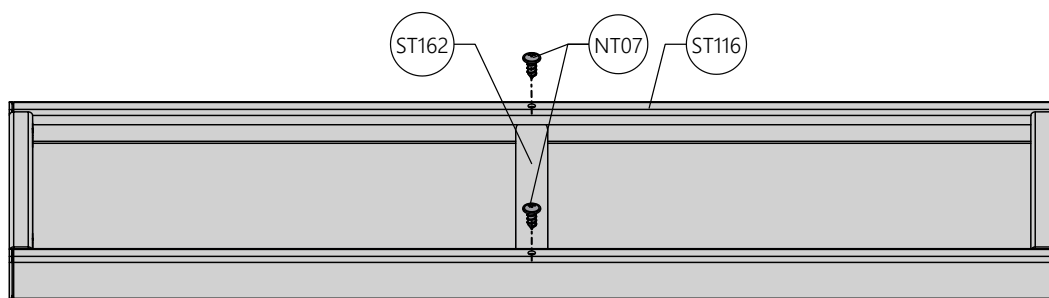
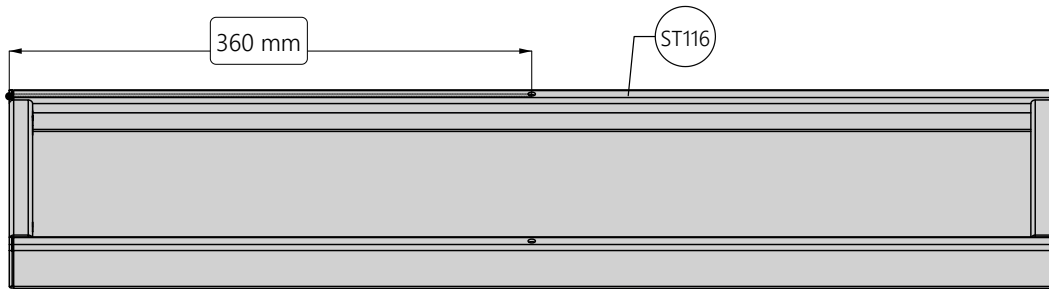
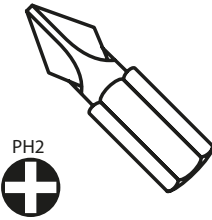
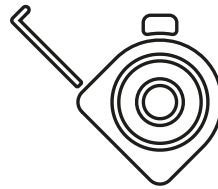
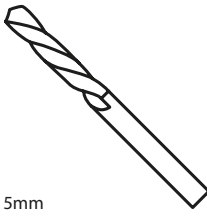

2

3

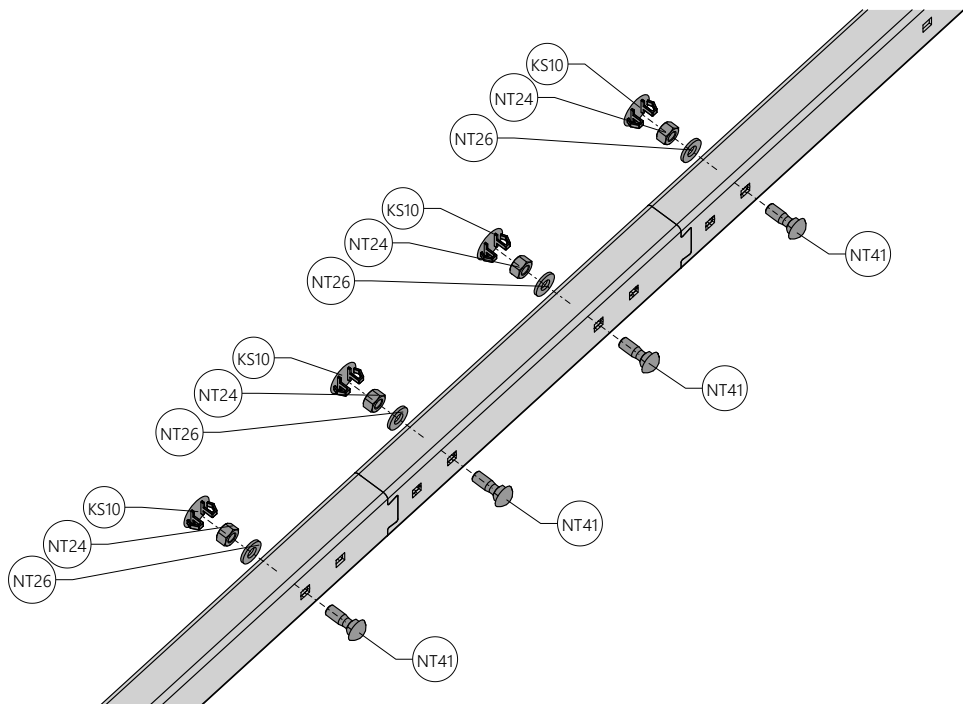
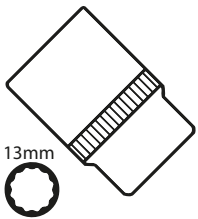
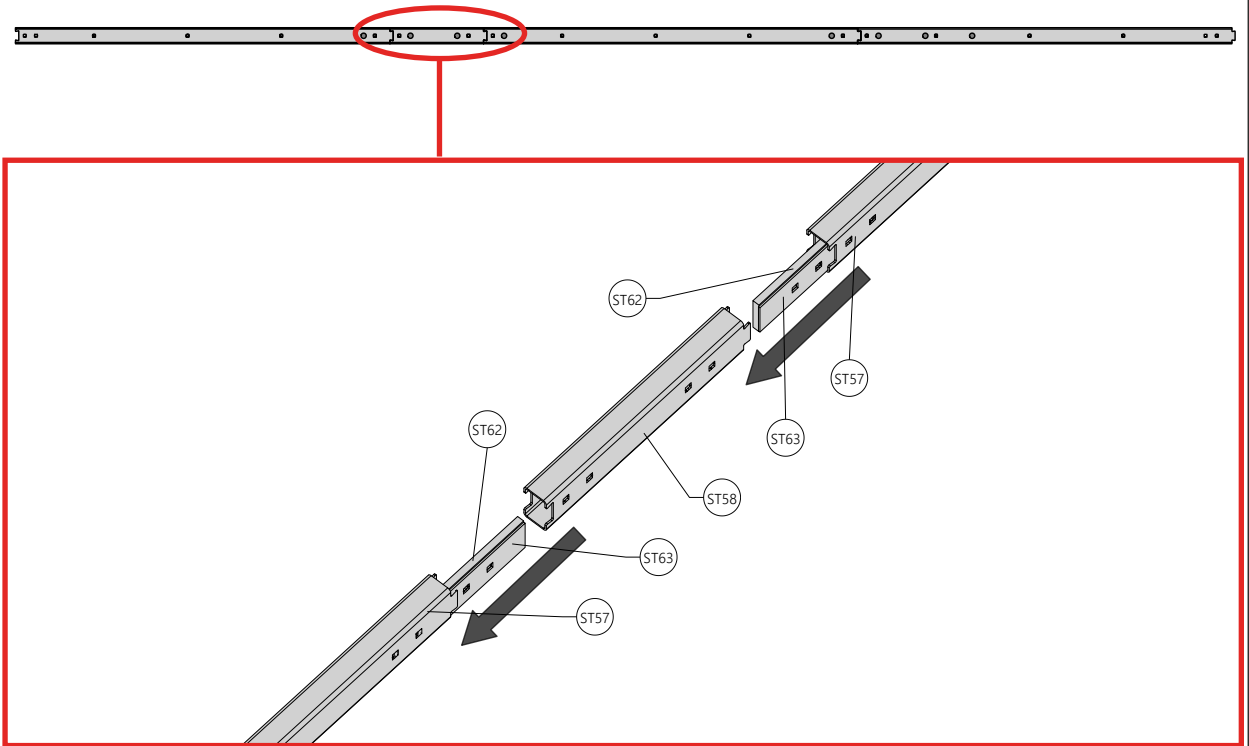

4

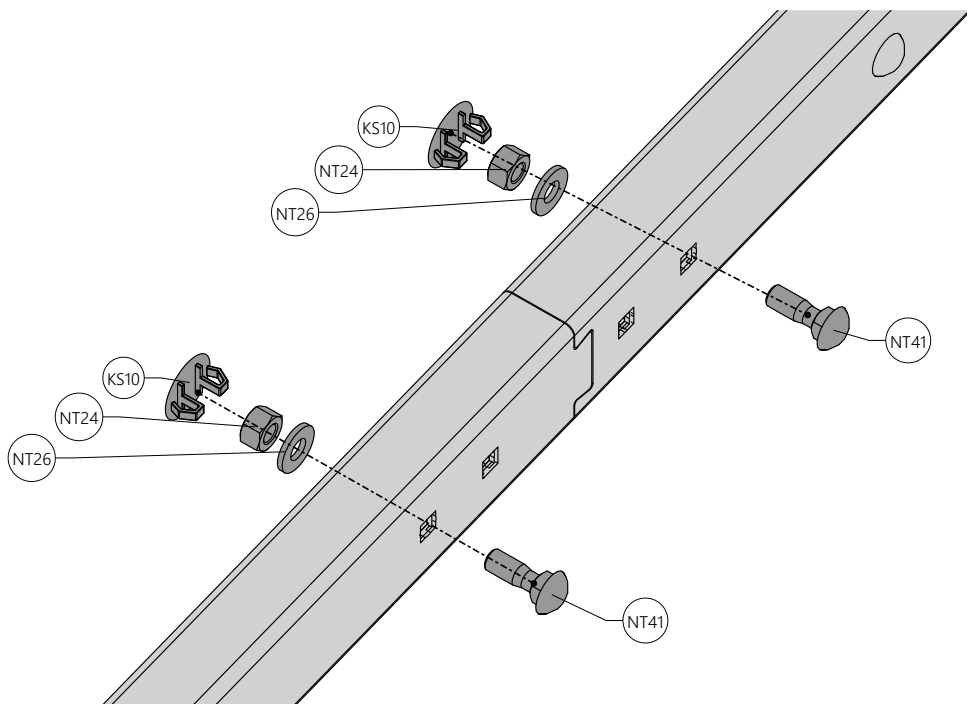
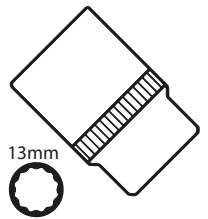
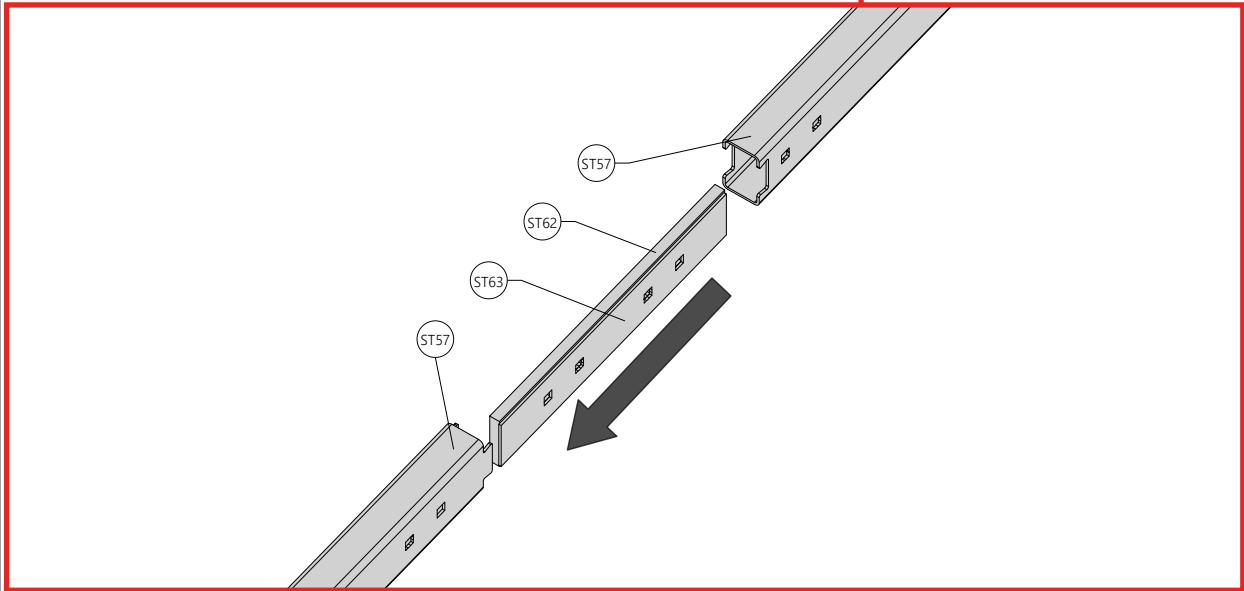

7

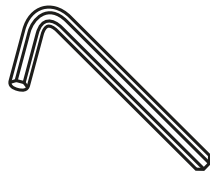
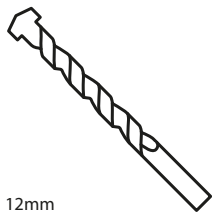
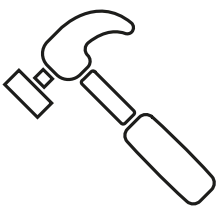
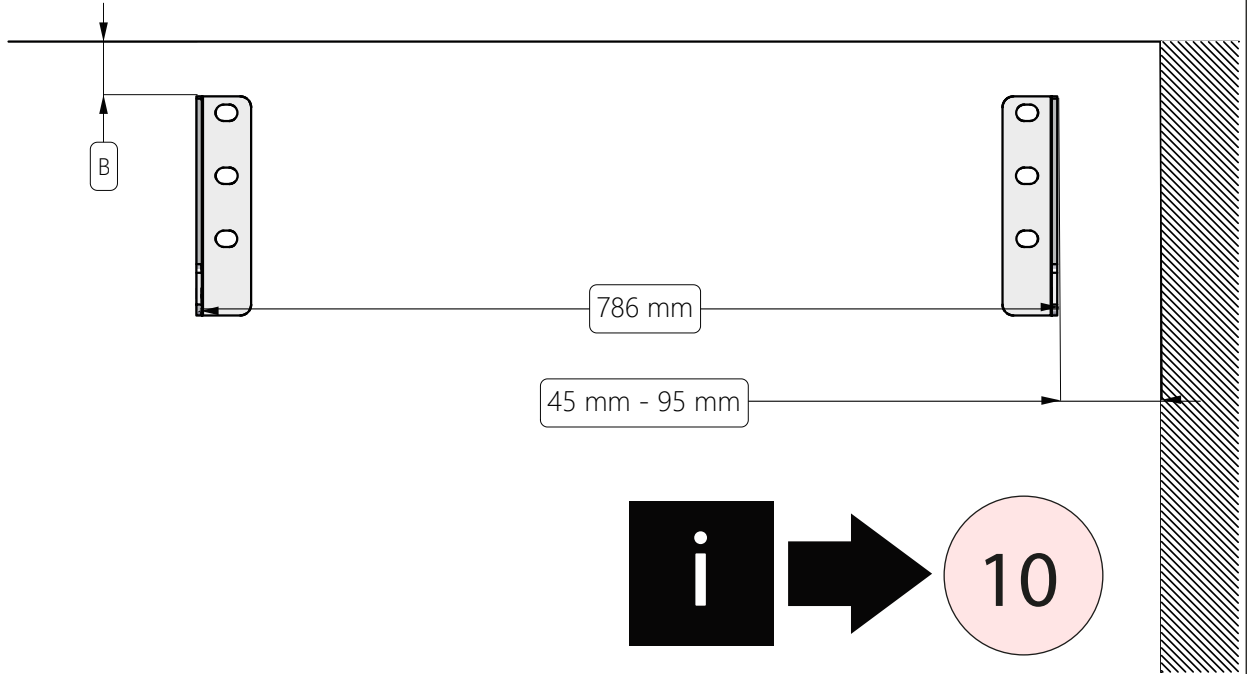
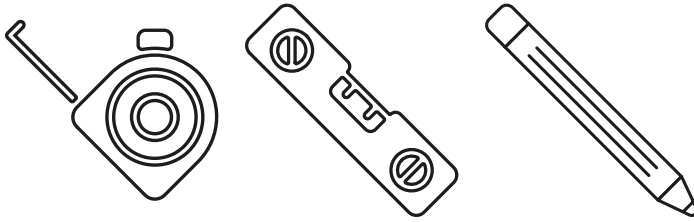

12mm

5mm

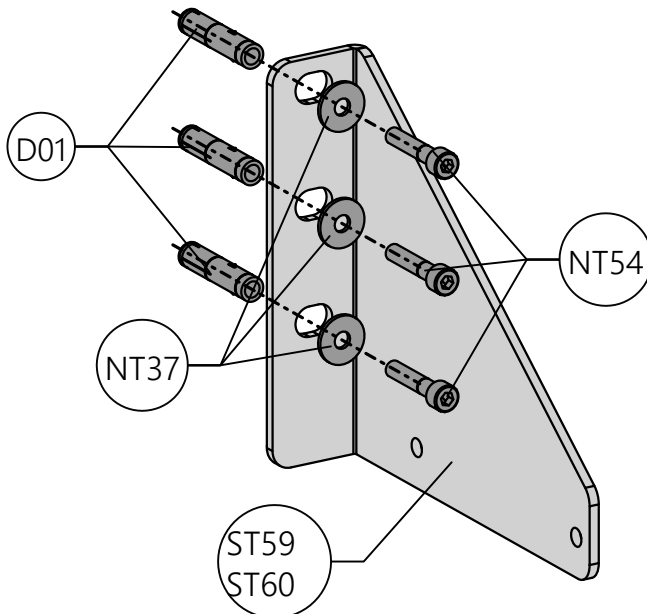
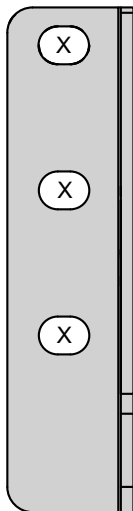

8

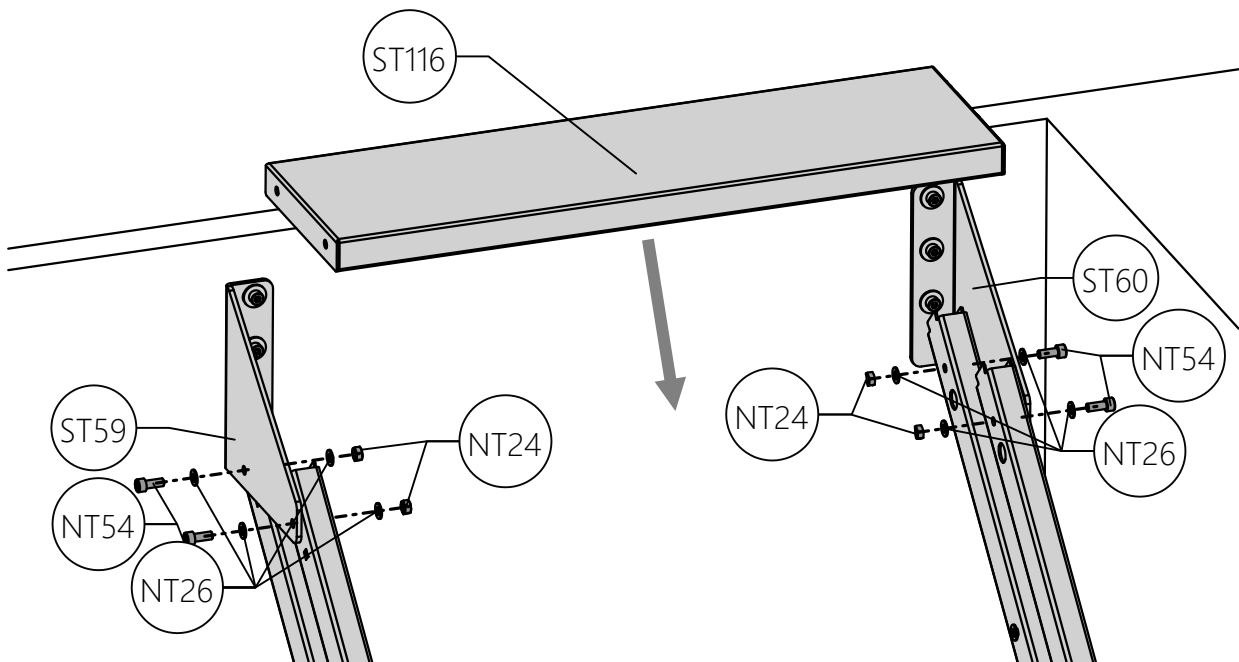
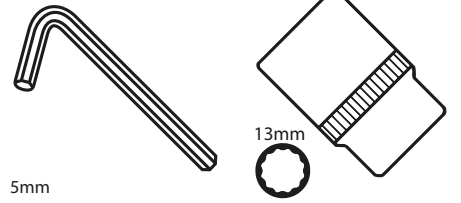
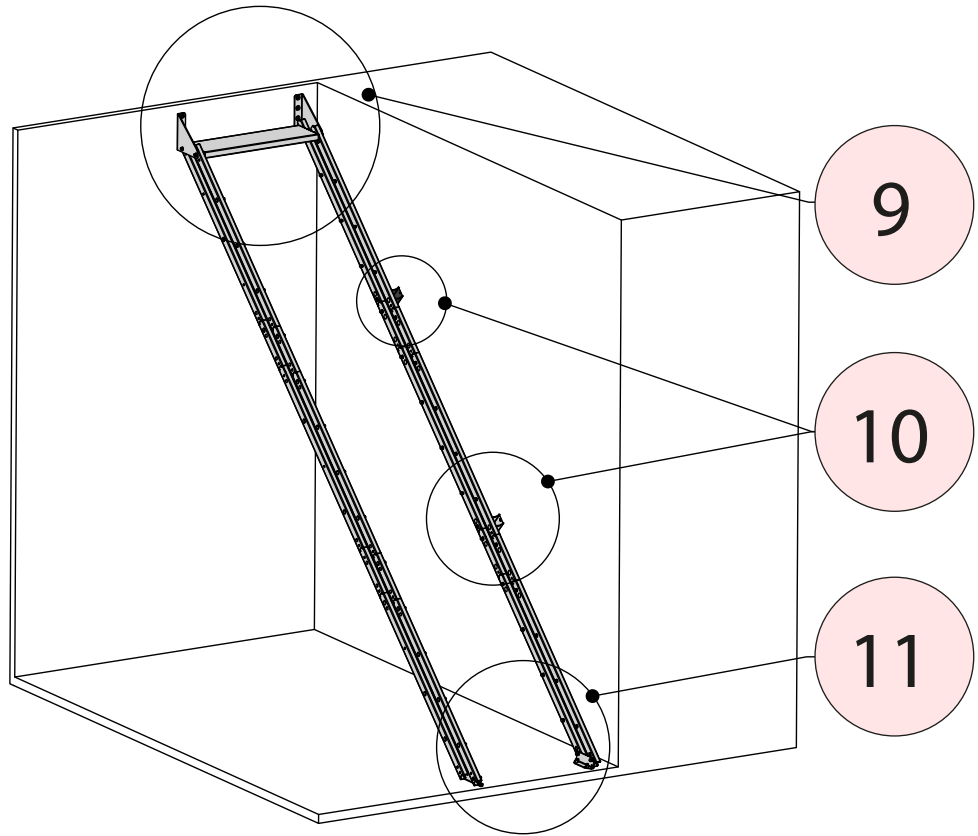

10

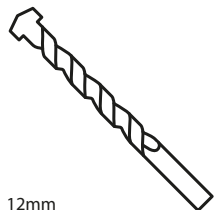
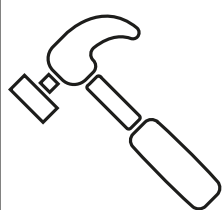
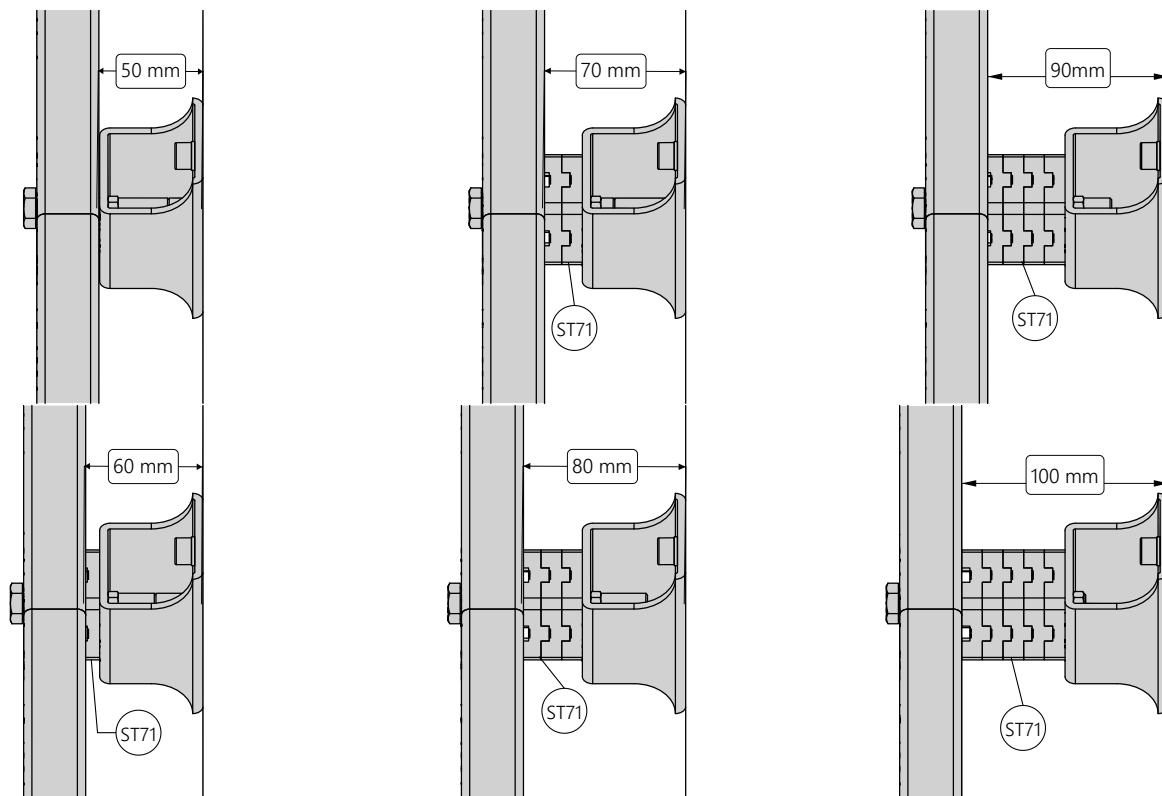

12mm

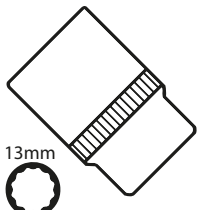

13mm

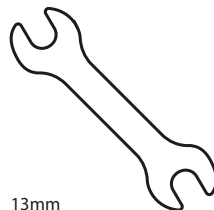

13mm

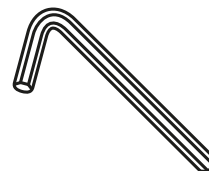

5mm

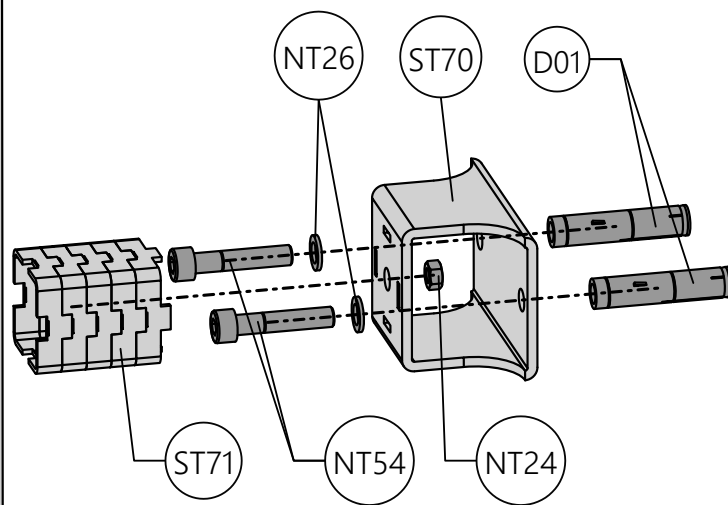
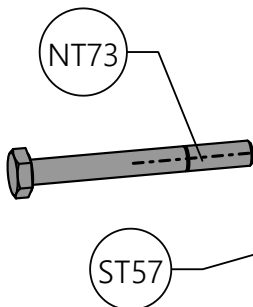
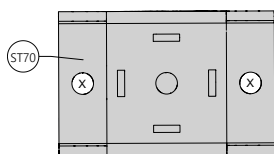

10b

11

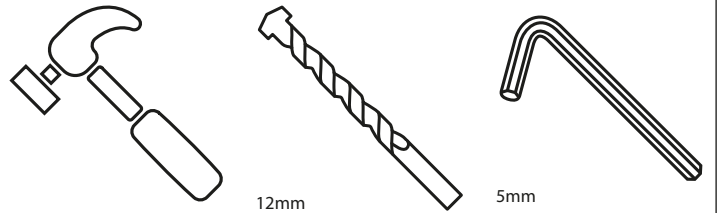
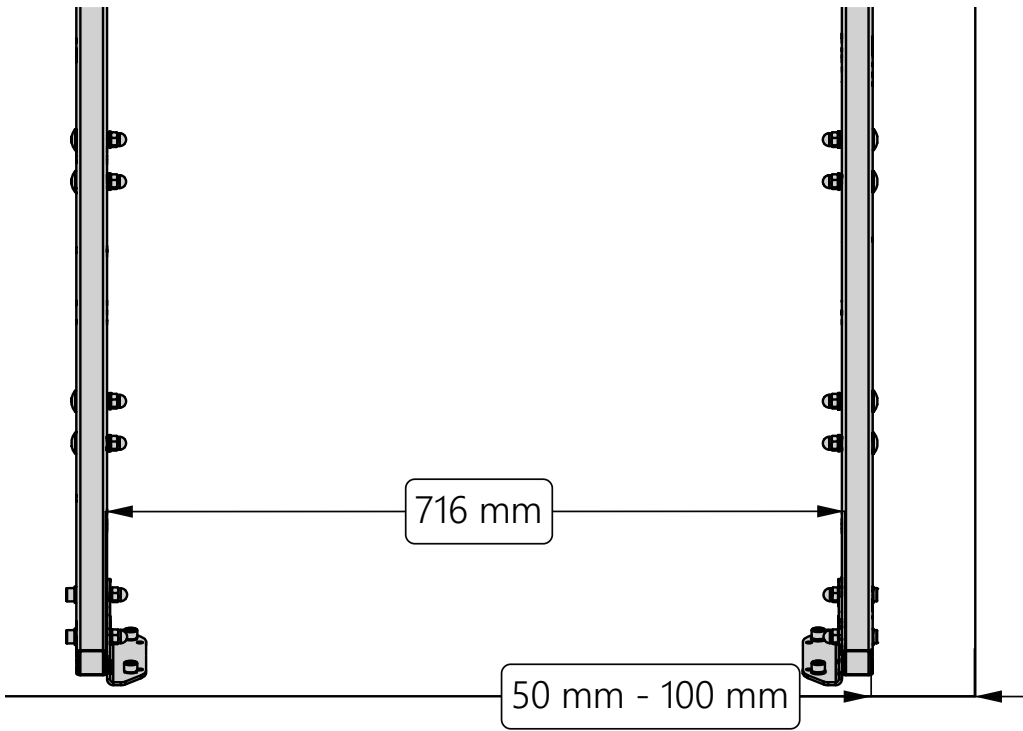
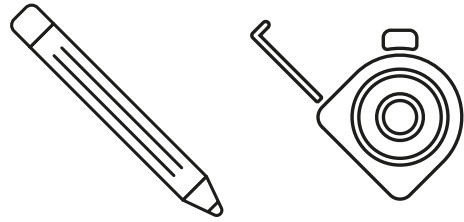

12mm

5mm

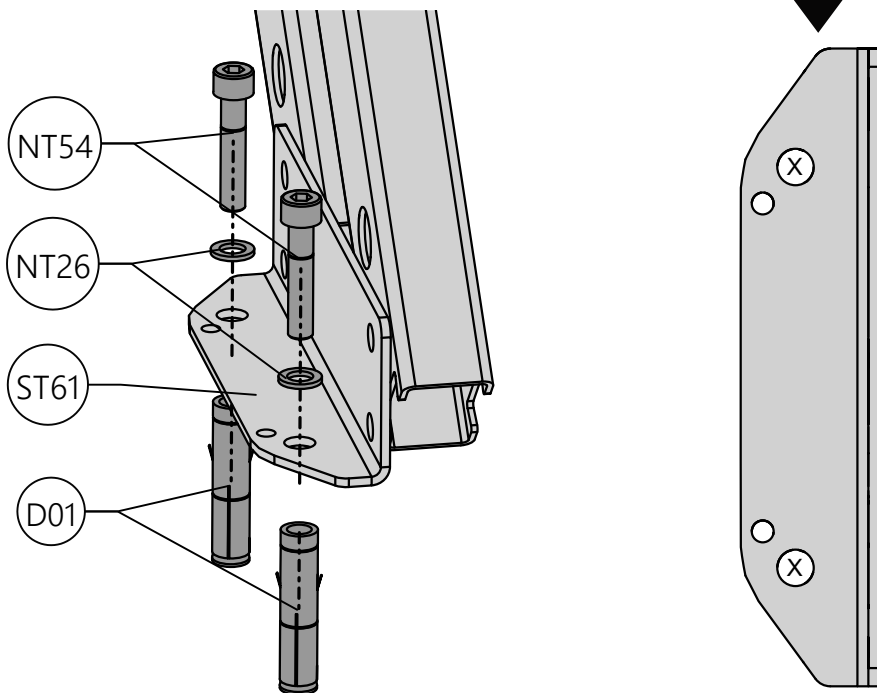

11b

11c

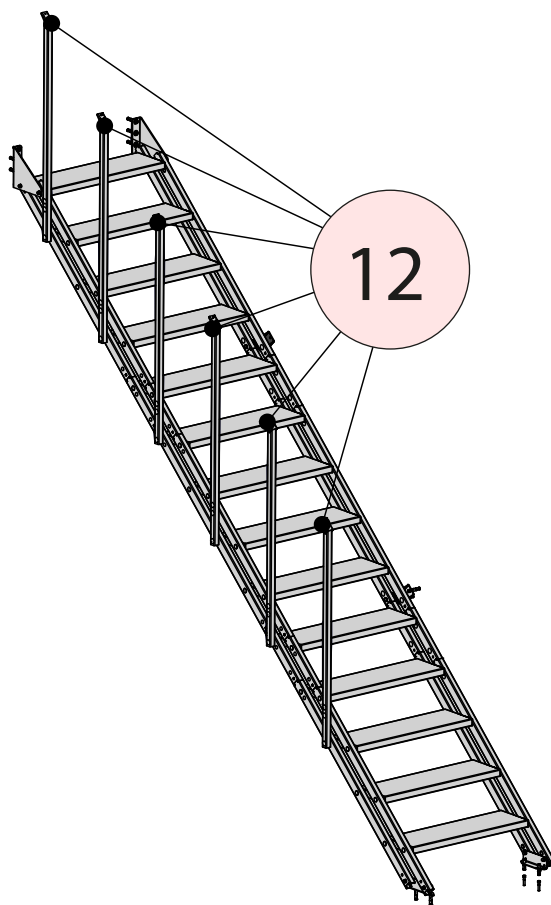
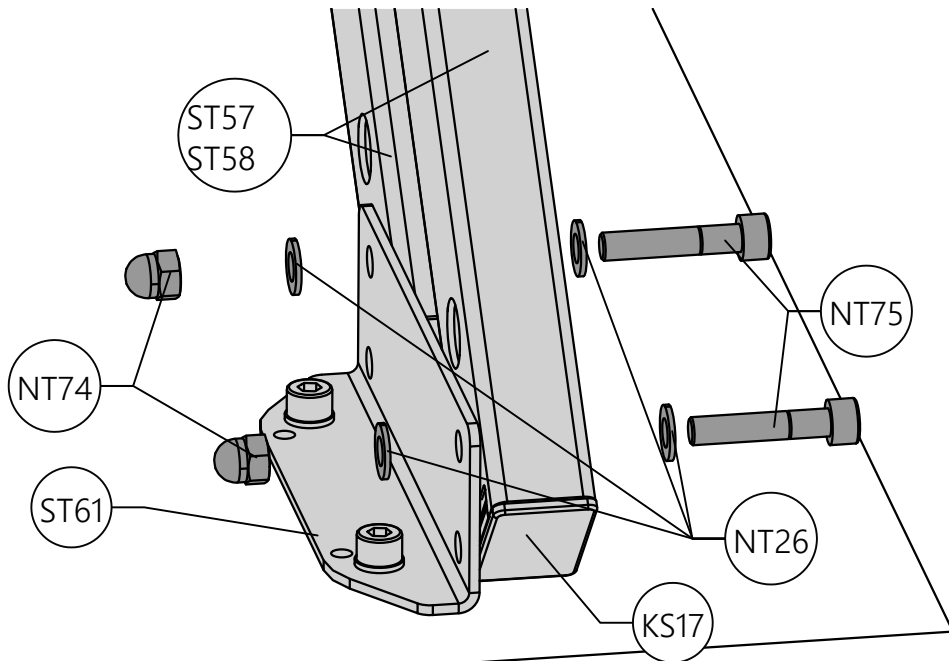
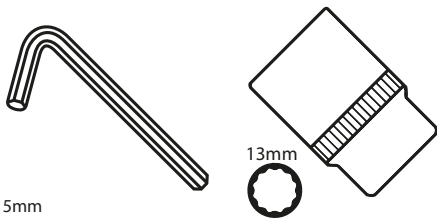



4mm

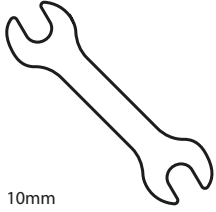

10mm

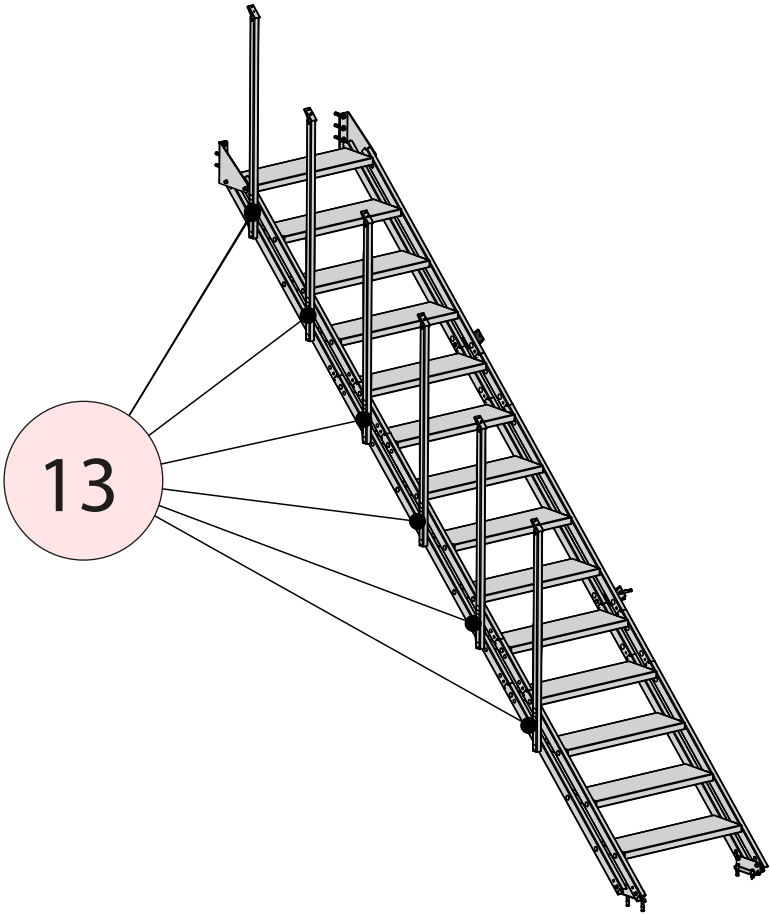
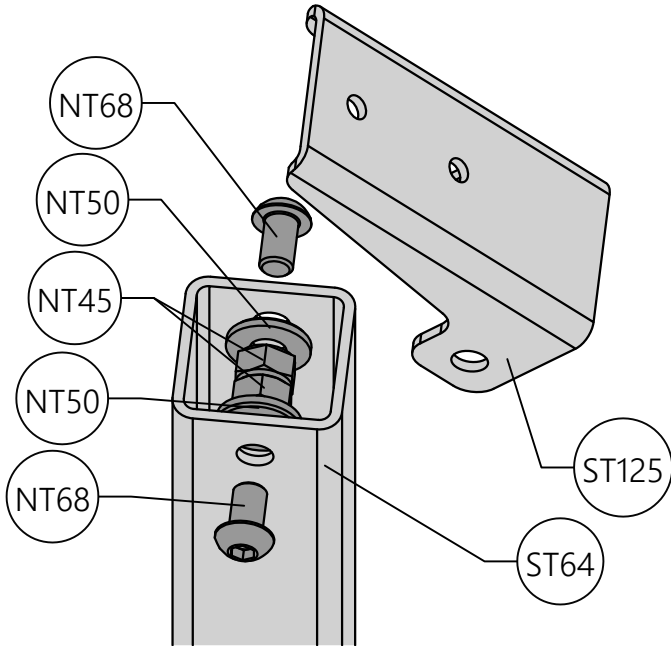

13

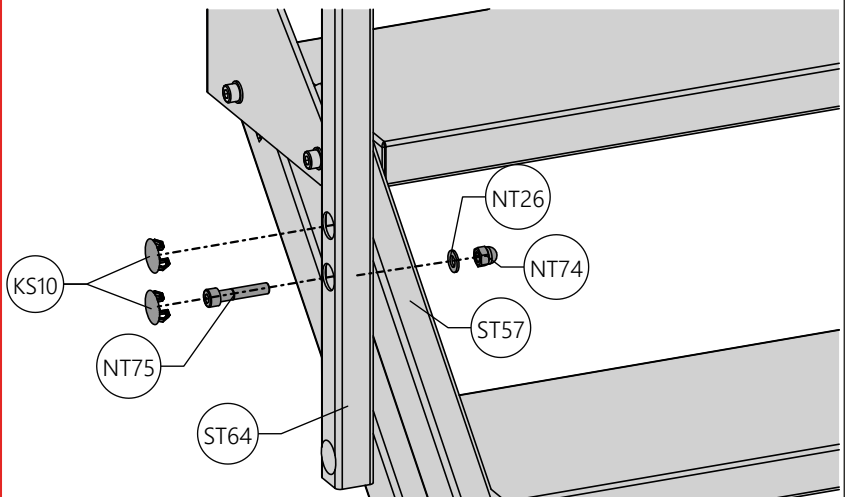
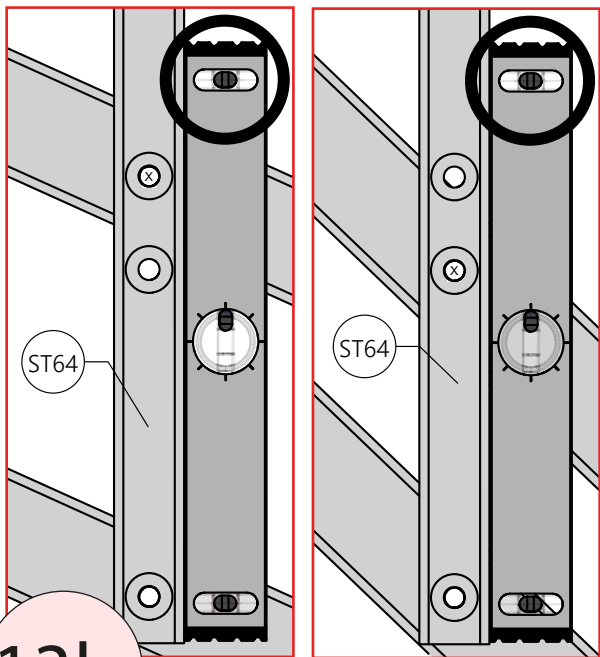
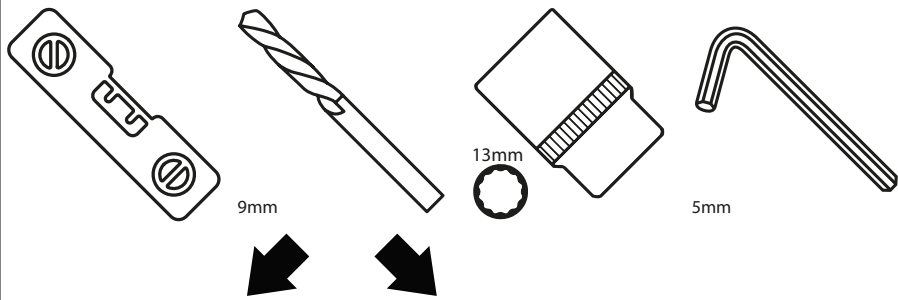
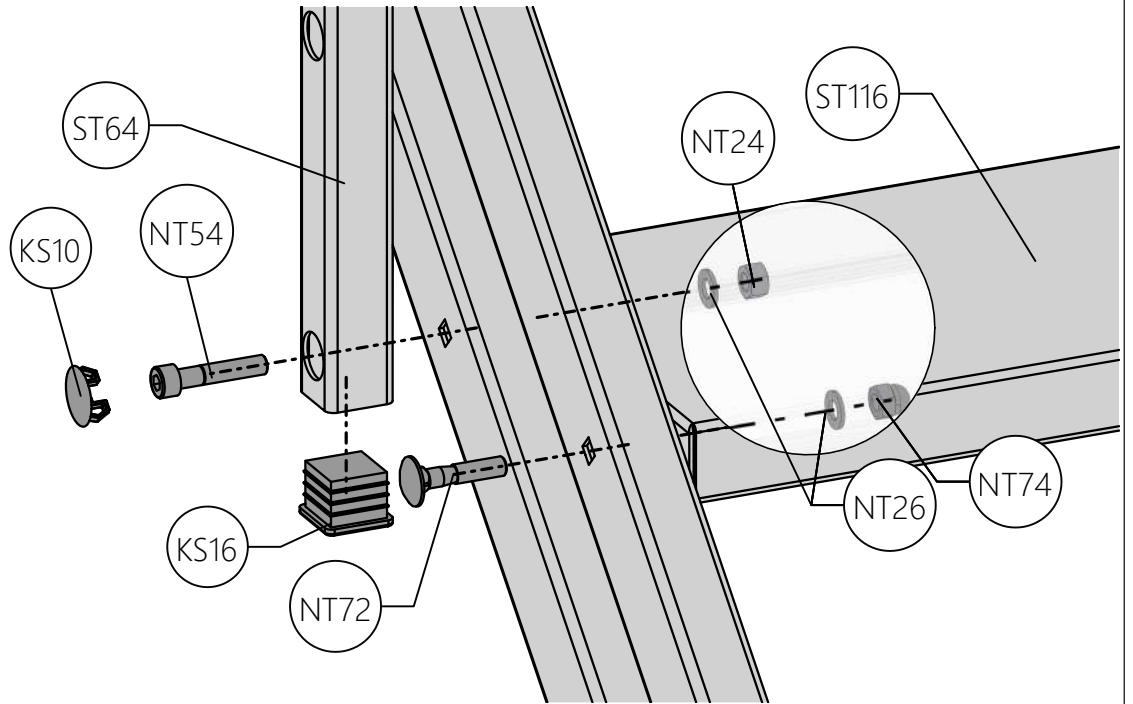
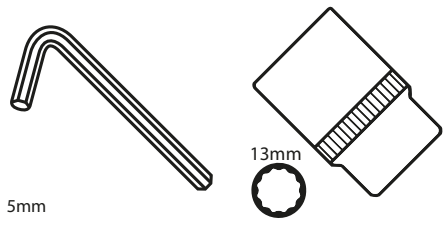

13b

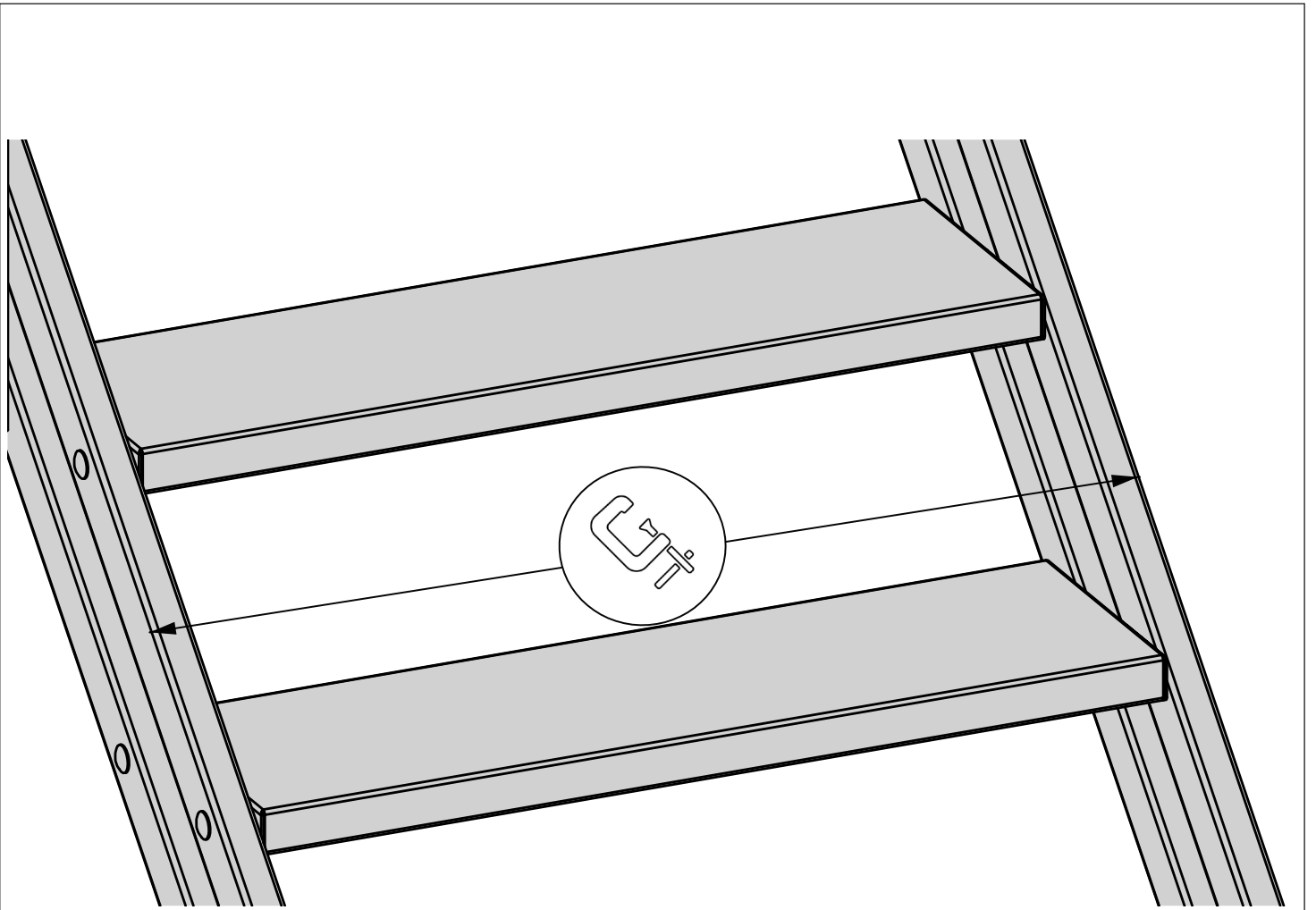

14

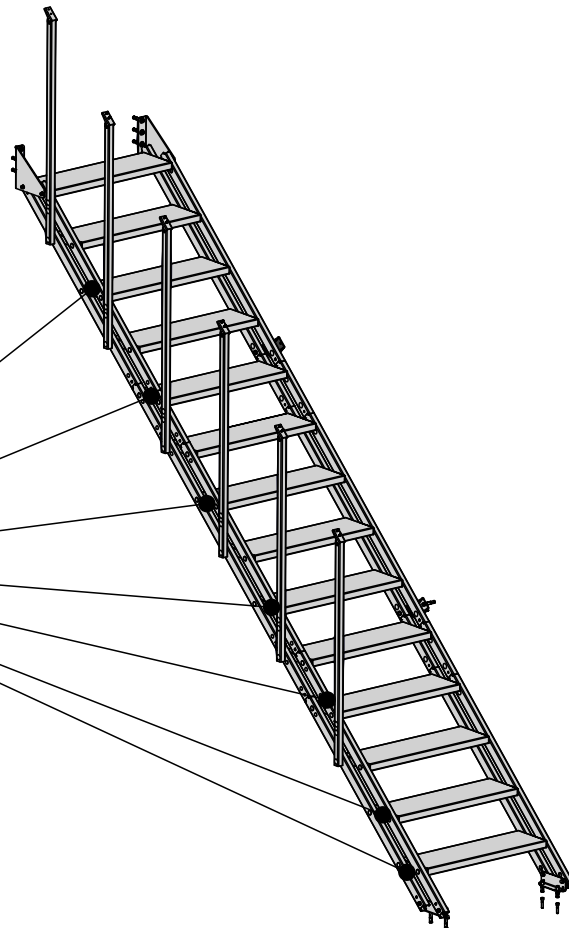

14

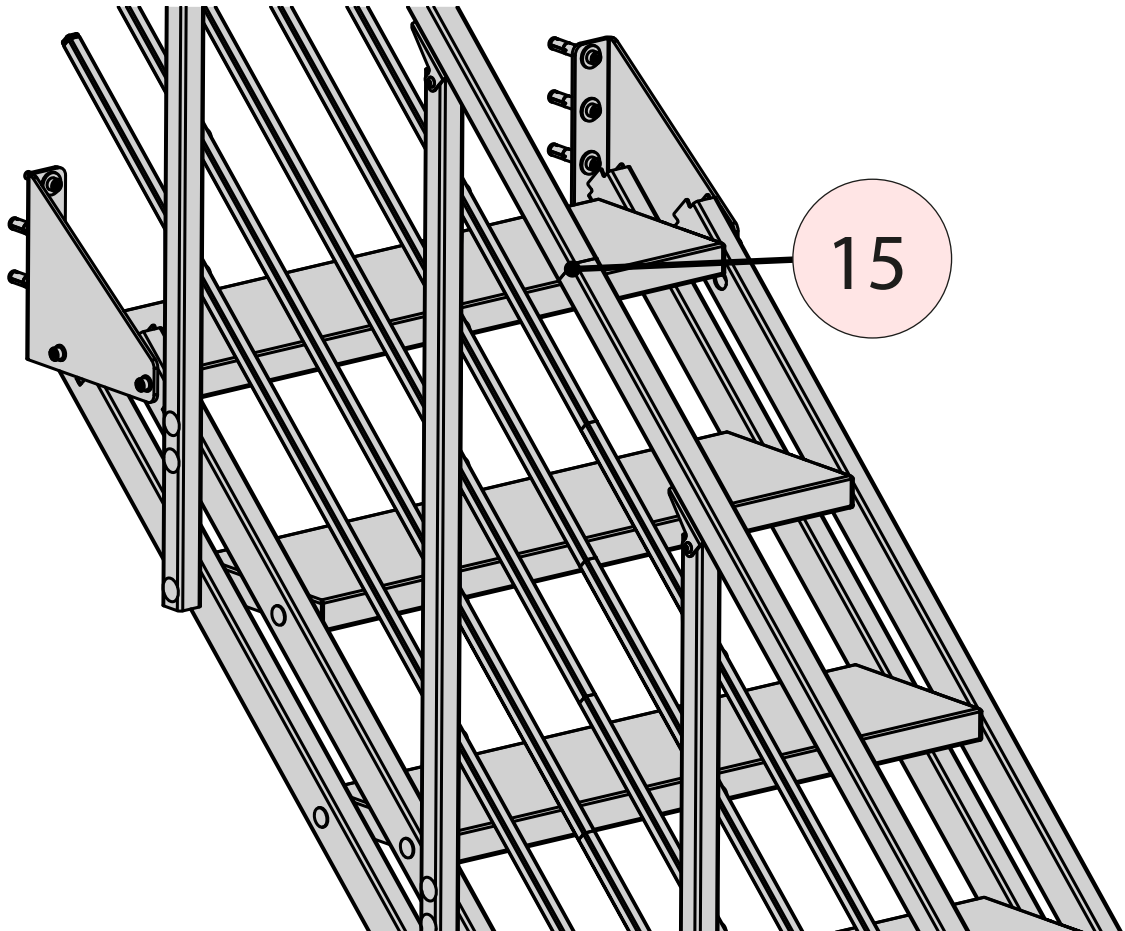
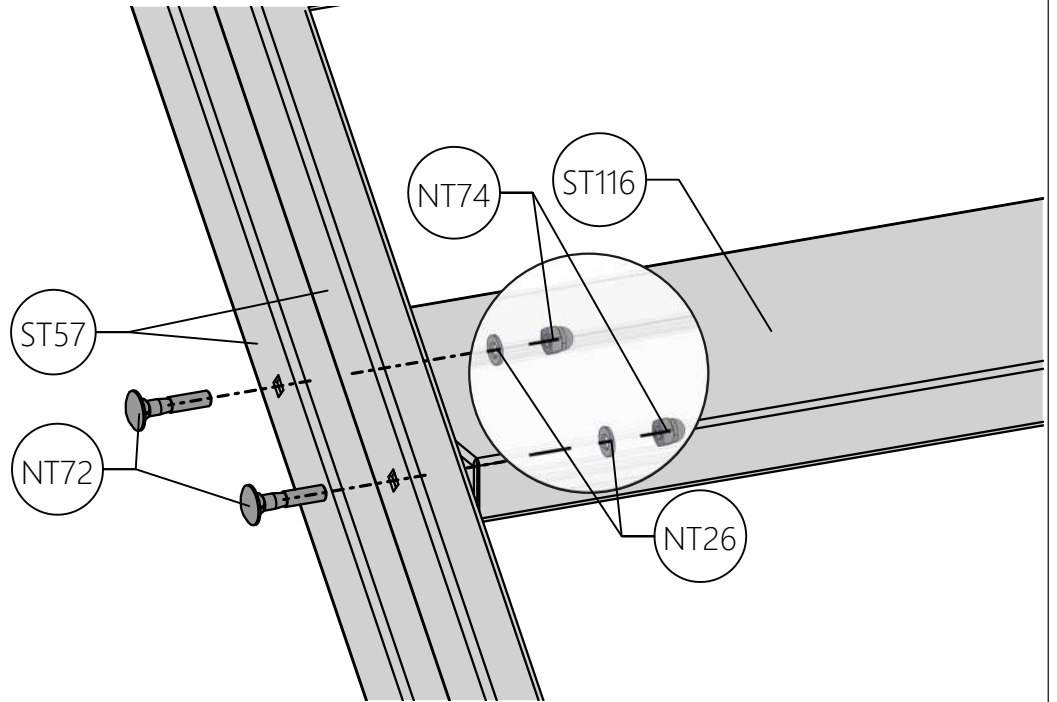
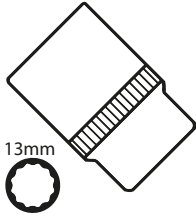

15

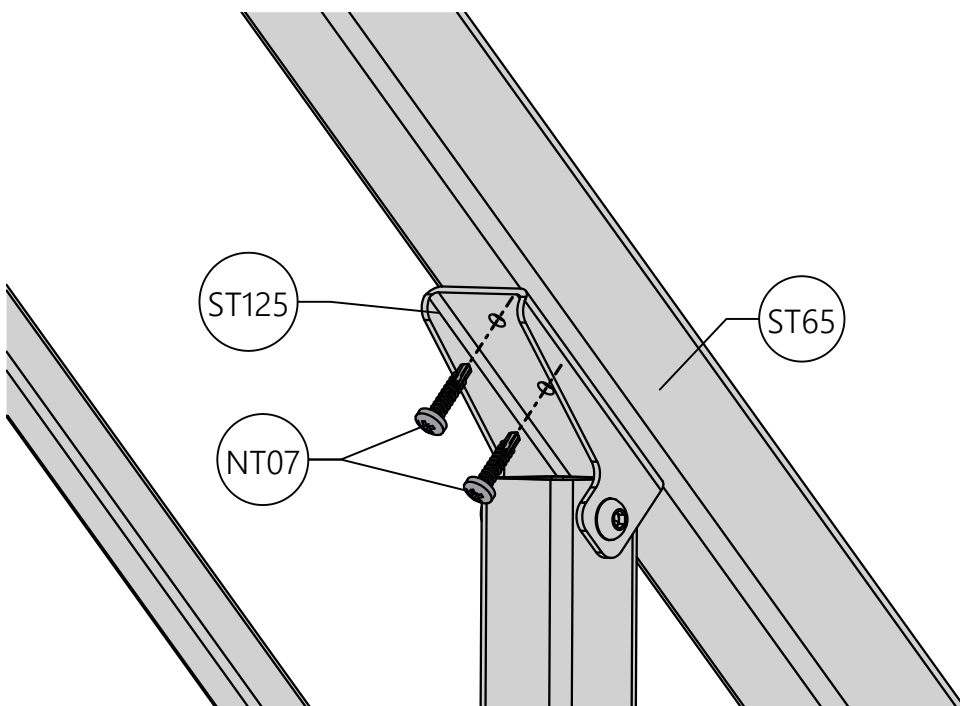
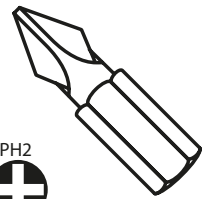
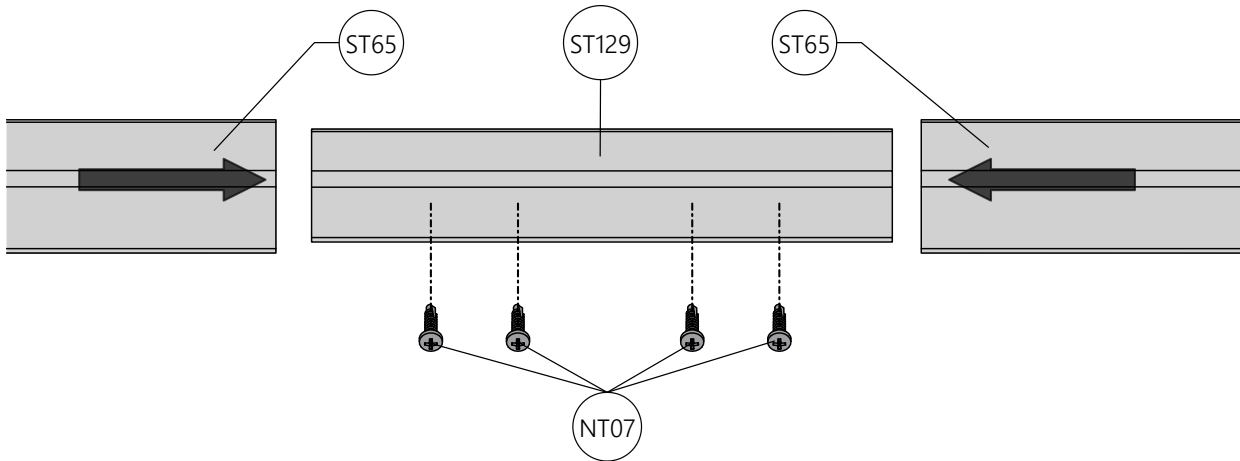
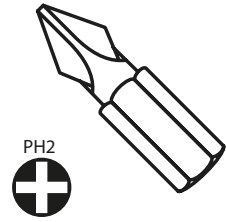

15b

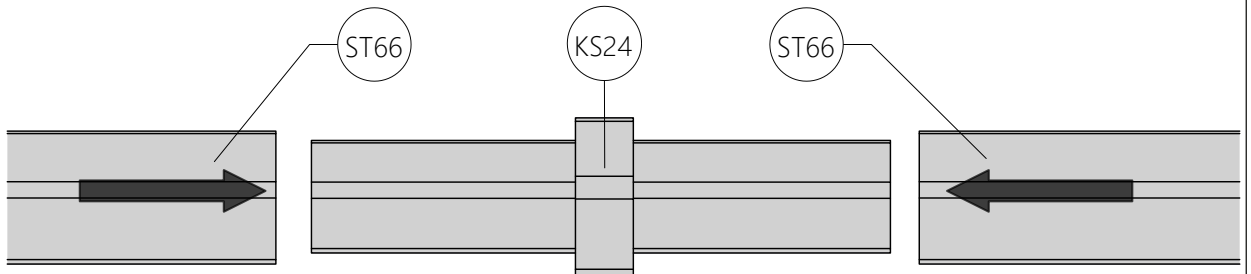
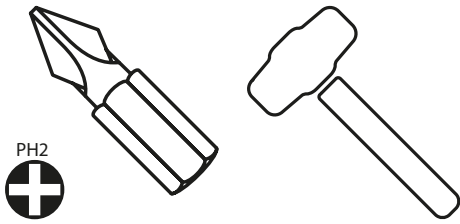
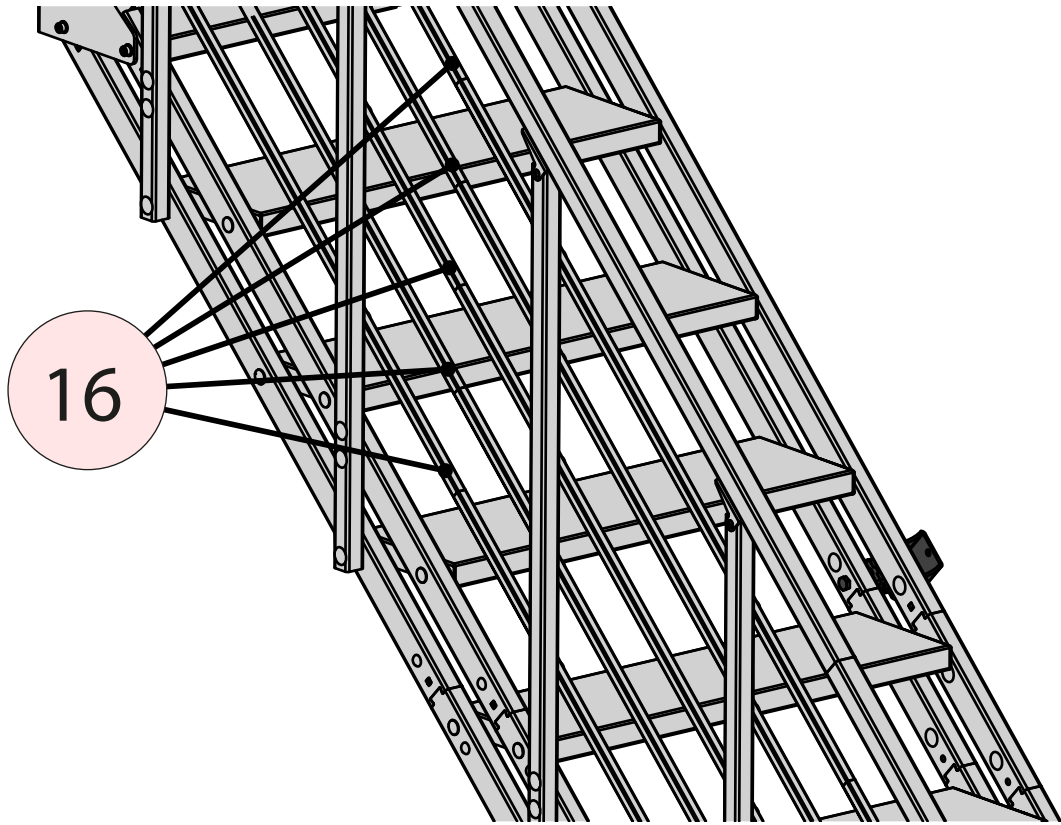

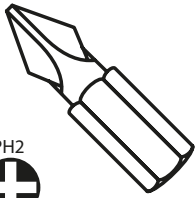

PH2
+

